

NEW COLORS 2020

DEKTON® SL|M

designed by COSENTINO



Ultra-Thin ⇄ **Large Format & Proven Performance**





DEKTON® S L | M

Presenting Dekton® Slim, the new, large format surface with an ultra-thin 4-mm thickness that offers unlimited design options and incredible ease of installation and transport.

Its lightness and reduced thickness makes it the most durable, high-performance surface for bathroom and kitchen cladding, as well as all types of furniture (doors, drawers, etc.).

4

Easy Installation

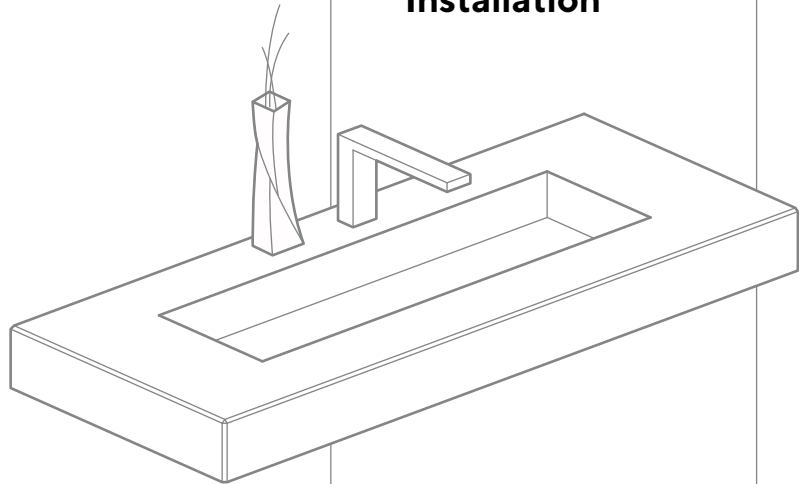

3

Furniture Cladding

Transforms your home furniture with beautiful, highly resistant surfaces.

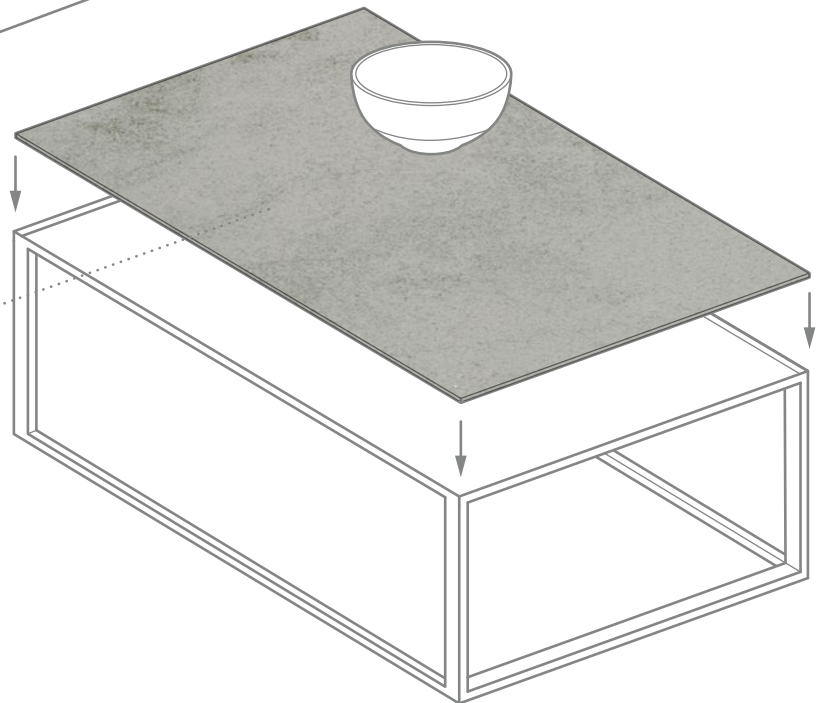



1

Bathroom Cladding

Maximum resistance against humidity with minimal joints.

2

Kitchen Cladding

Reduced thickness, infinite possibilities.



1

Bathroom Cladding

Maximum resistance against humidity with minimal joints in the light-weight Dekton® format.



Ideal for bathrooms, Dekton® Slim offers cladding that is ultra-resistant to humidity and stains. A high-performing product that does not require any more maintenance beyond a damp cloth.

Its large format measures 126" x 56" covers large surfaces, avoiding a large number of joints and in turn, less dirt.



**Fewer Joints
Greater Hygiene**



**Surfaces size
126" x 56"**



**Cut-to-size
Limitless customization**



**Same stain and scratch
resistance as other
Dekton formats**

2

Kitchen Cladding

Reduced thickness, infinite possibilities



The ultra-thin Dekton® Slim surface, with a thickness of 4 mm, is ideal for the cladding of kitchen walls and cabinets, in a harmonious blend of countertops of different thicknesses.

Dekton® Slim is scratch-resistant, fire-resistant and stain-resistant, just like its other formats.



Surface size
126" x 56"



Same stain and scratch
resistance as other
Dekton formats



Cut-to-size
Limitless customization

Dekton Slim is not suitable for kitchen countertops.

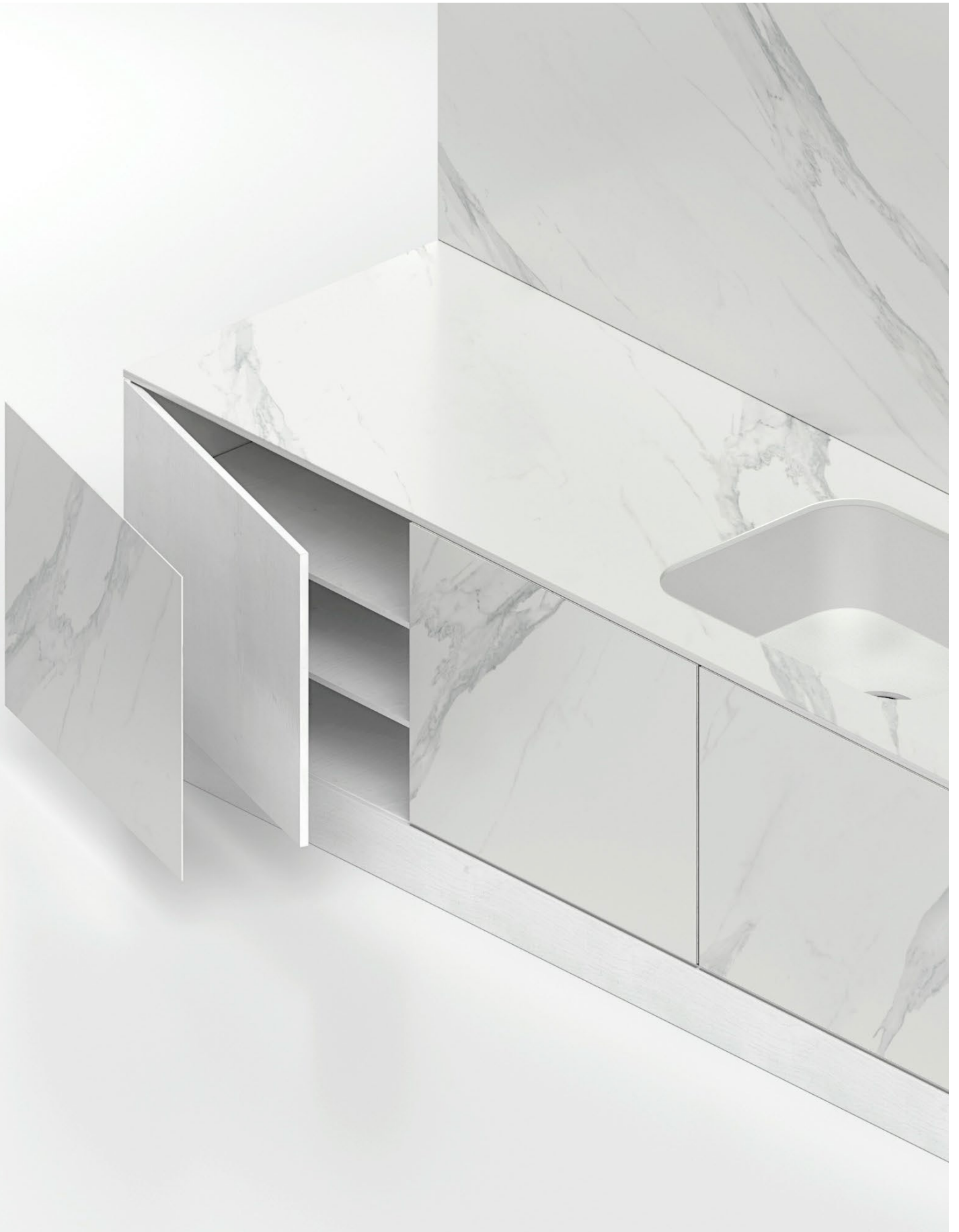







3

Furniture Cladding

Transforms your home furniture with beautiful, highly resistant surfaces



Dekton® Slim creates furniture with unprecedented performance: tables that are resistant to everything and doors that neither scratch nor stain. The size possibilities are endless since it is cut-to-size and easy to install.

Limitless Design

Dekton® Slim is very simple to install and can be cut with great ease. It is the ideal surface to personalized your furniture with innovative designs.

Whatever you can imagine, Dekton® Slim can do for you.



**Cut-to-size
Limitless customization**



**Same stain and scratch
resistance as other
Dekton formats**

4

Easy Installation

Everything is easier with Dekton® Slim



Thanks to its light-weight format with an array of possibilities, everything just got a lot simpler. Its reduced thickness means it can be cut quickly and adjustments can be made on-site with tools for ceramic tiles. Dekton slim is a material with no internal tension, so there is no need to cut it to release tension. With a light weight of 2.95 lbs / sq ft., it is so easy to install.

It is important to read and familiarize yourself with the safety measures in order to handle construction materials.



At Cosentino we offer **personalized Customer Service**. Ask as many questions you like and request all the advice you need to ensure you get exactly what you want out of the new Dekton® Slim.

Find your nearest Cosentino Center at www.cosentino.com



Easy to Cut and Create



Easy to Handle and Transport



Easy to Install



Personalized Customer Service



Available Colors

Check out our new colors at dekton.com/slim

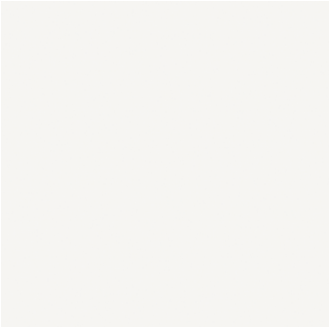

Halo - XGLOSS Solid

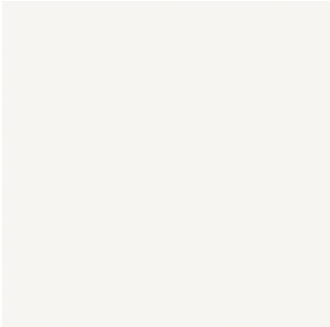

Zenith - SOLID Collection



Nayla - NATURAL Collection



Rem - NATURAL Collection

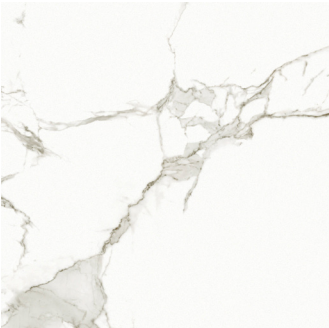

Aura 15 - NATURAL Collection



Opera - NATURAL Collection



Helena - STONIKA



Natura 18 - XGLOSS Natural



Lunar - INDUSTRIAL Collection



Edora - NATURAL Collection

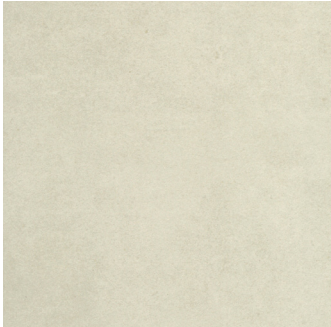

Sasea - NATURAL Collection



Bergen - STONIKA



Arga - STONIKA



Kovik - NATURAL Collection



Sirocco - NATURAL Collection



Trilium - INDUSTRIAL Collection



Laos - INDUSTRIAL Collection



Bromo - NATURAL Collection

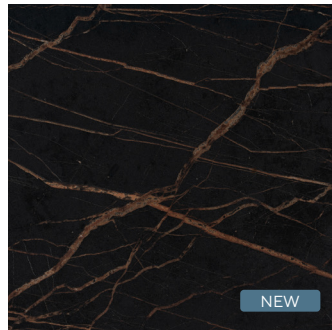

Laurent - NATURAL Collection

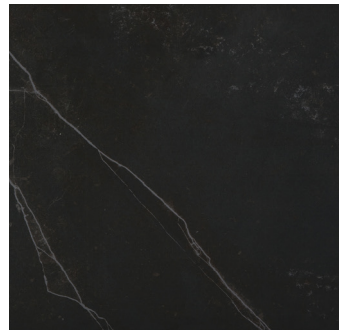

Kelya - NATURAL Collection

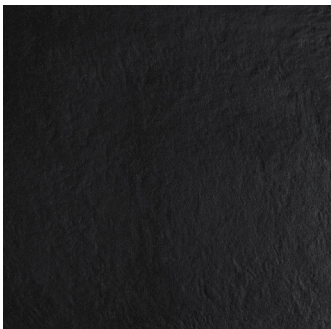

Sirius - SOLID Collection

Packaging and Handling

Dekton Slim is sold in packages of 5 or 10 slabs. For larger projects, the packaging will be optimized in bundles, depending on the project requirements.

We recommend ordering the material meshed on back, as handling is improved. This material is handled with tools for large-format transport.



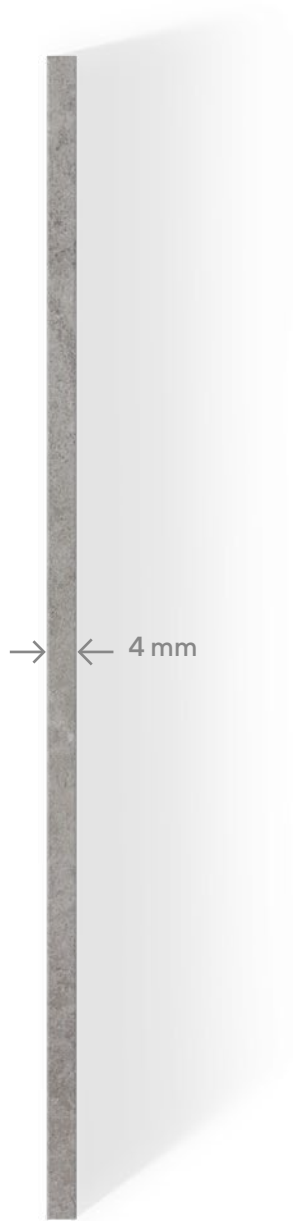

Ultra-Thin → ← **Large Format & Proven Performance**





COMPANY WITH
MANAGEMENT SYSTEM
CERTIFIED BY DNV GL
= ISO 9001 =
= ISO 14001 =

** Get information on NSF-certified colors at www.nsf.org

A product designed by **COSENTINO**

COSENTINO NORTH AMERICA

355 Alhambra Circle, Suite 1000 Coral Gables, FL 33134
Phone: 786.686.5060 | www.cosentino.com | www.dekton.com

   @CosentinoUSA