

PERFORATED METALS

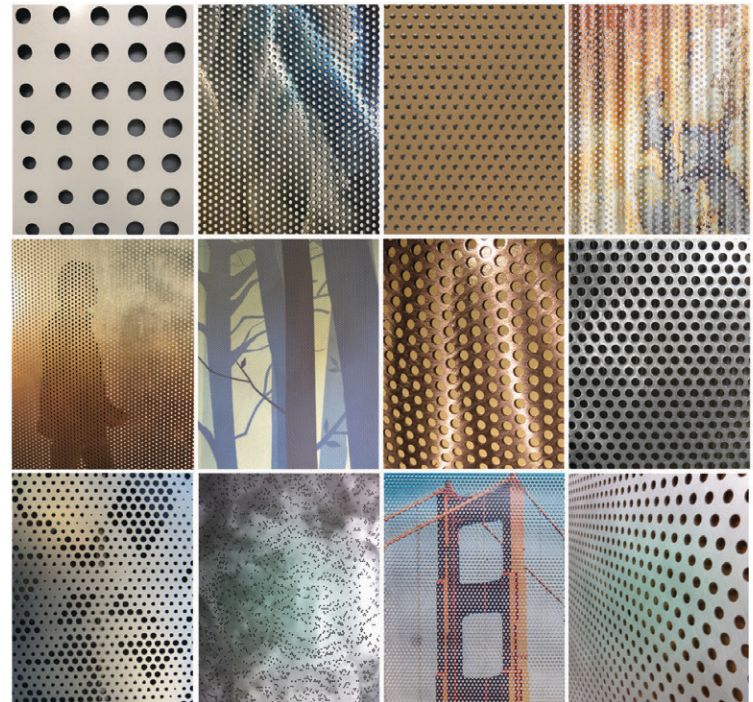

Standard Color Collections
Custom Digital Artwork
Durable Finish Options
Extended 10 - 20 Year Exterior

Custom Options Available





Powder Coat Finishes

Superior Durable finishes available for interior and exterior applications. 12 standard colors with custom available. Extended warranties available.

More Colors Available Online



Black Sand



Bronze Sand



Silver Metallic

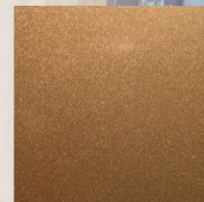

Copper Metallic



Rust



Rusted Copper



Hole Profiles

We carry perforated metals in 5 standard perforated hole profiles.

Custom hole profiles and material thicknesses also available.

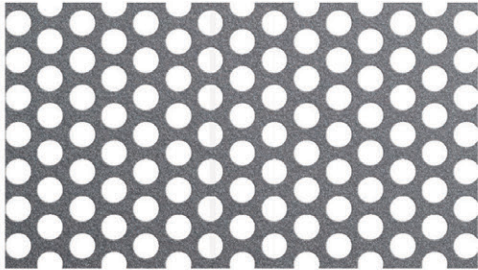

1/8" Diameter
3/16" Staggered Centers / 40% Open Area

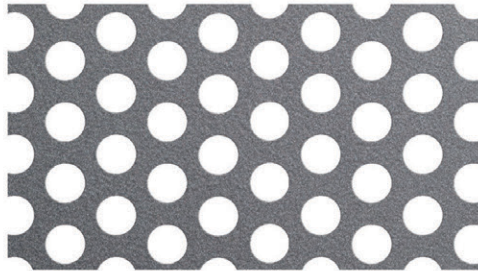

3/16" Diameter
5/16" Staggered Centers / 33% Open Area

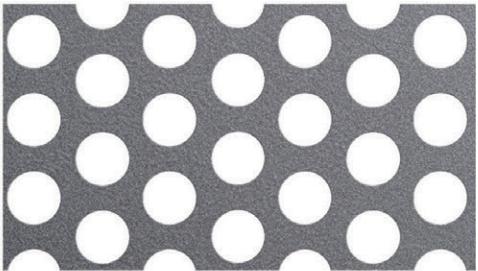

1/4" Diameter
3/8" Staggered Centers / 40% Open Area

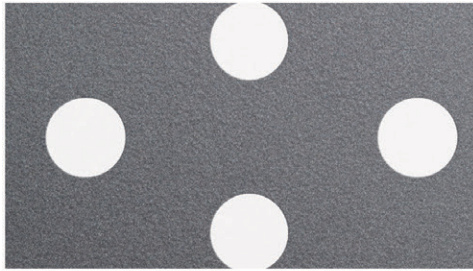

3/8" Diameter
3/4" Staggered Centers / 23% Open Area

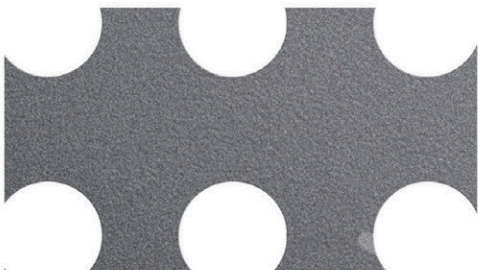

1/2" Diameter
1" Straight Centers / 20% Open Area

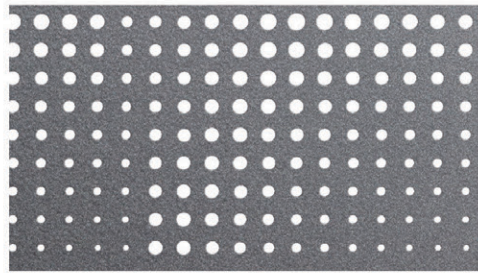

Custom Hole Size

Stand Off Attachments

Panels include standoffs with painted fasteners for a complete wall \ ceiling solution ready for installation.

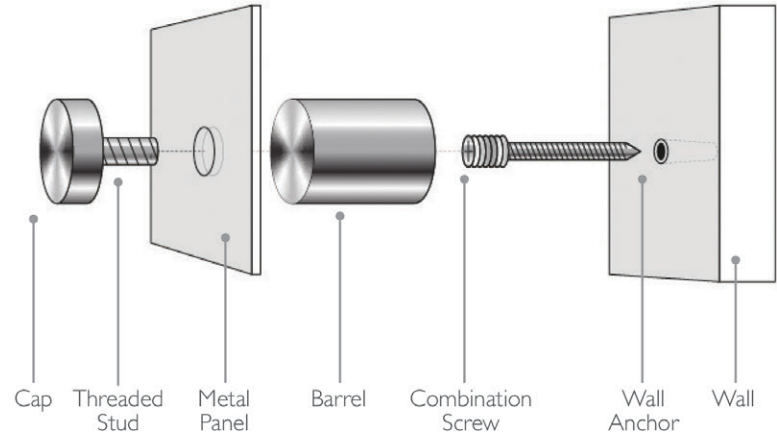

Gripper Attachments

Panels include posts with brackets and grippers for a complete room divider kit ready for installation.





Edge Options

Complete an installation of Móz Metal sheets with Aluminum Edge Frame Trims or have us incorporate a solid margin to create a more finished look.

Contact us for custom options.

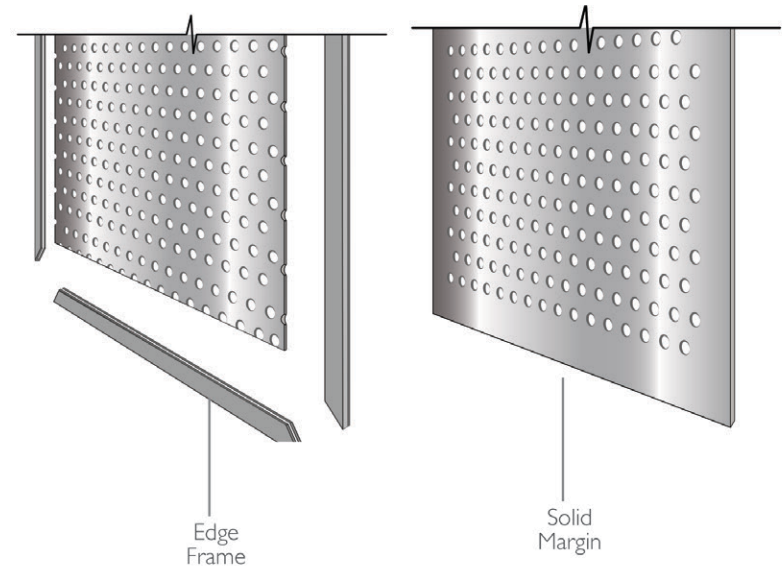

Móz Perforated metals are 100% manufactured in the USA and contribute to LEED®v4 Materials and Resources Credits.

Applications

Columns

Exterior Panels

Wall Panels

Ceilings

Infill Panels

Room Dividers



Metals + Architectural Products

(510) 632-0853

mozdesigns.com



LOCAL



FAMILY OWNED



LEED®v4