



**STACKED
WOOD**

ENGINEERED HARDWOOD WALL PANELS



2090 FLUTED WALNUT



2093 HEX OAK - OIL



2095 INTERSQUARE WALNUT

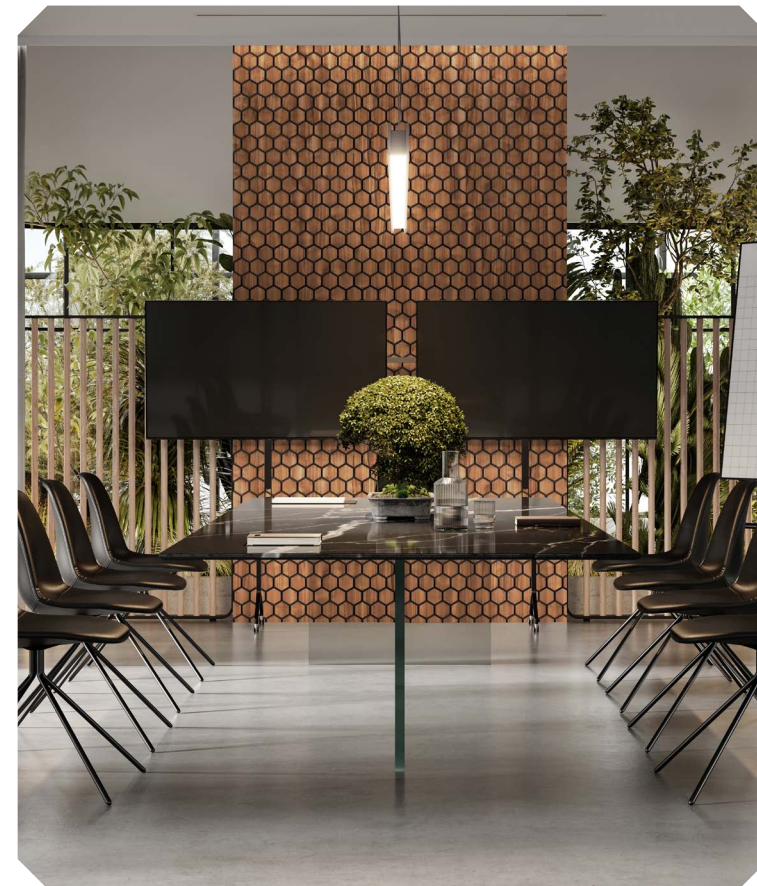

2092 HEX WALNUT



2096 PEAKS WALNUT

FINISH

Fluted Walnut, Intersquare Walnut,
Peaks Walnut, Hex Walnut:
10% U.V. Varnish with Antimicrobial Additive
Hex Oak - Oil: 100% Natural Oil

WIDTH/LENGTH

Fluted Walnut: 11.75"/ 96"
Intersquare Walnut: 15.7"/ 47.2"
Hex Oak - Oil, Hex Walnut: 11.75"/ 45.9"
Peaks Walnut: 15.5"/ 47.2"

SPECIES

Fluted Walnut, Hex Walnut,
Peaks Walnut, Intersquare Walnut:
Walnut with an MDF Core
Hex Oak - Oil:
White Oak with an MDF Core

THICKNESS:

Fluted Walnut, Intersquare Walnut,
Hex Oak - Oil, Hex Walnut,
Peaks Walnut: 0.51"

COVERED AREA PER CASE

Fluted Walnut: 7.8 Sq.ft. per panel
Intersquare Walnut: 15.3 Sq.ft.
Hex Oak - Oil, Hex Walnut: 11.1 Sq.ft.
Peaks Walnut: 15.3 Sq.ft.



2090 FLUTED WALNUT



2095 INTERSQUARE WALNUT

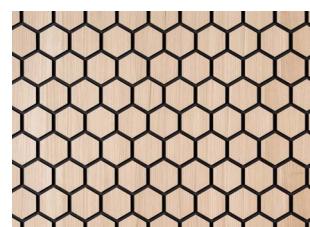

2093 HEX OAK - OIL

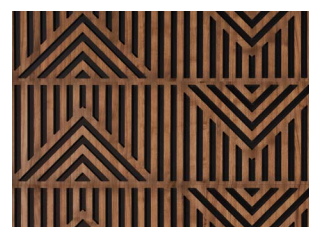

2096 PEAKS WALNUT

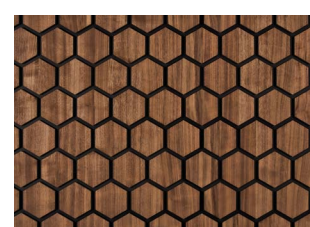

2092 HEX WALNUT

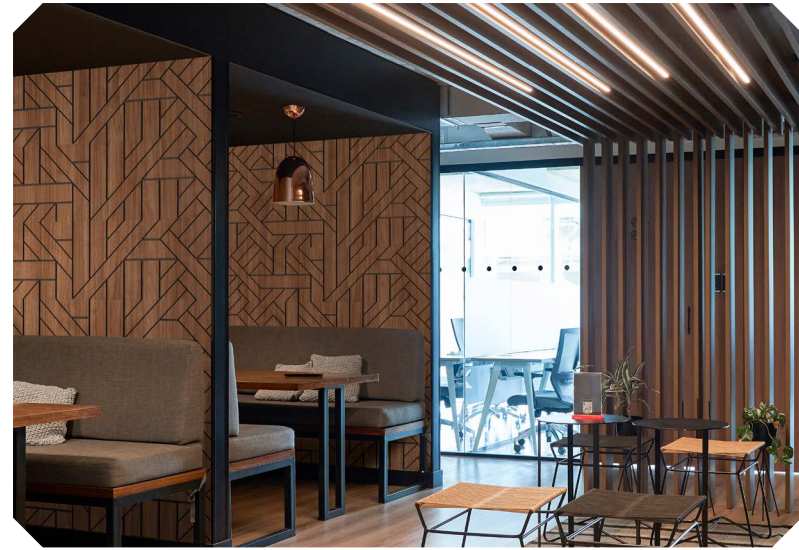

2094 AMAZED WALNUT

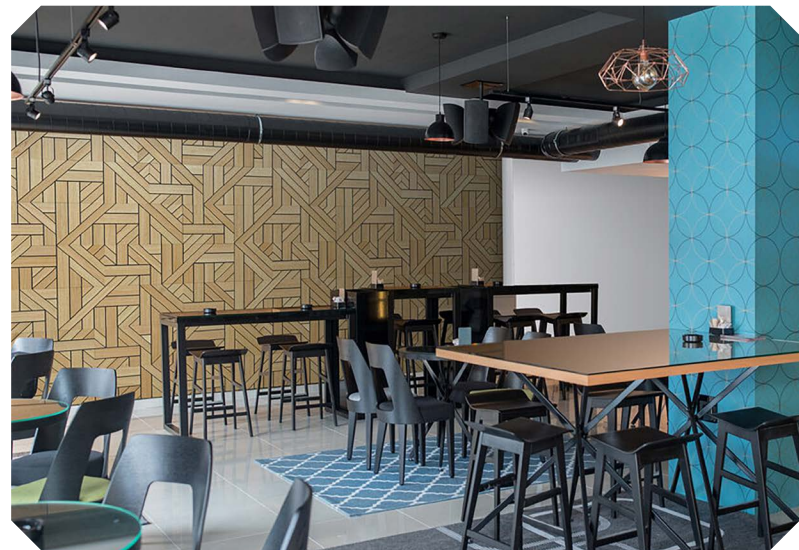

2031 AMAZED OAK

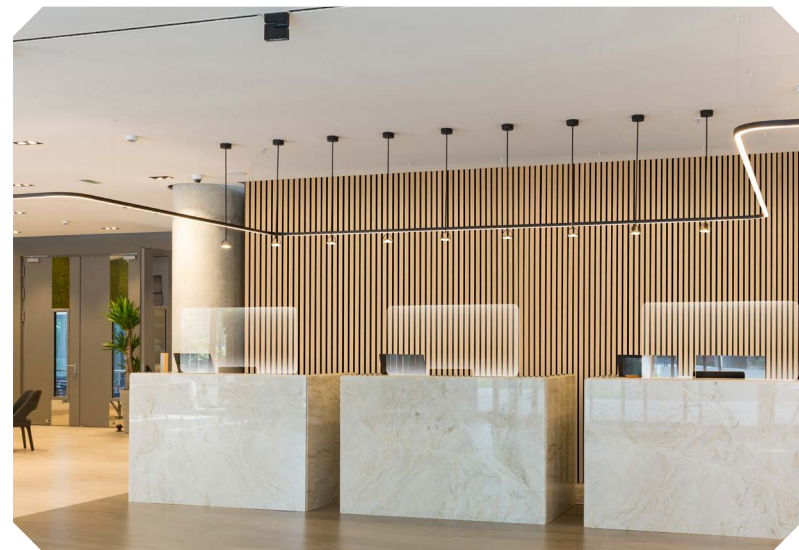

2036 FLUTED OAK

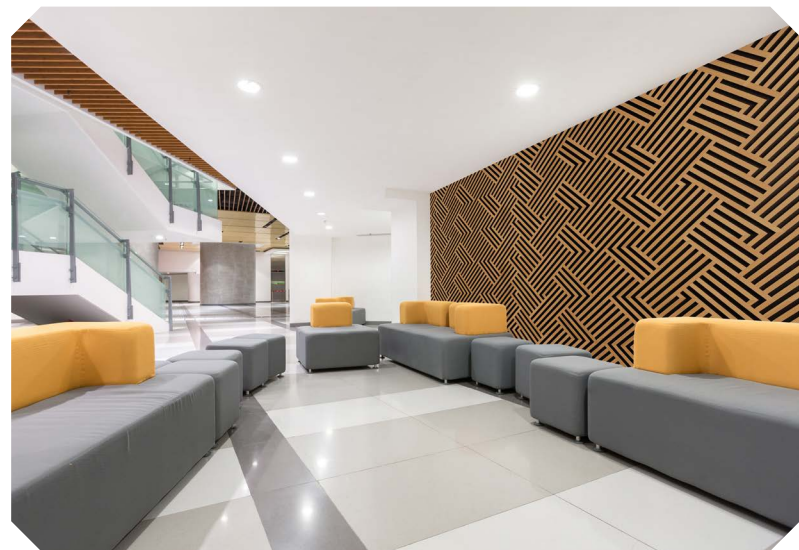

2038 INTERSECT OAK



2091 INTERSECT WALNUT



2094 AMAZED WALNUT

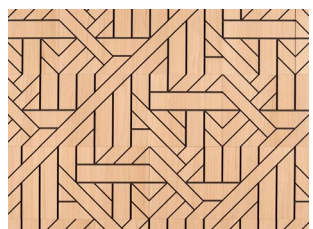

2031 AMAZED OAK



2036 FLUTED OAK

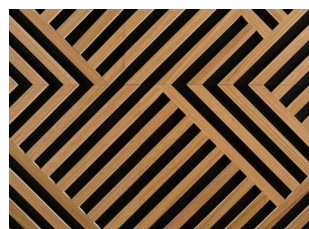

2038 INTERSECT OAK



2091 INTERSECT WALNUT

FINISH

Amazed (Oak/Walnut), Fluted Oak,
Intersect (Oak/Walnut) :
10% U.V. Varnish with Antimicrobial Additive

WIDTH/LENGTH

Amazed (Oak/Walnut): 14.4"/ 47.1"
Fluted Oak: 11.75"/ 96"
Intersect (Oak/Walnut): 15.4"/ 47.6"

SPECIES

Amazed Oak, Fluted Oak, Intersect Oak:
White Oak with an MDF Core
Amazed Walnut, Intersect Walnut:
Walnut with an MDF Core

THICKNESS:

Amazed (Oak/Walnut): 0.51"
Fluted Oak: 0.51"
Intersect (Oak/Walnut): 0.51"

COVERED AREA PER CASE

Amazed (Oak/Walnut): 21.7 Sq.ft.
Fluted Oak: 7.8 Sq.ft. per panel
Intersect (Oak/Walnut): 15.27 Sq.ft.

Paintable Collection



FINISH
 Amazed, Fluted, Hex, Intersect,
 Intersquare, Peaks:
 Unfinished

SPECIES:
 Amazed, Fluted, Hex,
 Intersect, Intersquare, Peaks:
 100% MDF with a laminate backer

COVERED AREA PER CASE
 Amazed: 14.1 Sq.ft.
 Fluted: 7.8 Sq.ft. per panel
 Hex: 11.1 Sq.ft.
 Intersect, Peaks: 15.27 Sq.ft.
 Intersquare: 15.3 Sq.ft.

WIDTH/LENGTH
 Amazed: 14.4"/ 47.1"
 Fluted: 11.75"/ 96"
 Hex: 11.75"/ 45.9"
 Intersect: 15.4"/ 47.6"
 Intersquare: 15.7"/ 47.2"
 Peaks: 15.5"/ 47.2"

THICKNESS:
 Amazed, Fluted, Hex, Intersect,
 Intersquare, Peaks: 0.48"

The Paintable collection is made out of nude 12 mm MDF. The panels are unfinished and intended to be painted to your desired color. * It is recommended to paint the panel with acrylic primer and paint to seal. *Consult with your local paint store for specific product information.*



2084 AMAZED PAINTABLE



2086 PEAKS PAINTABLE



2081 HEX PAINTABLE



2082 INTERSECT PAINTABLE

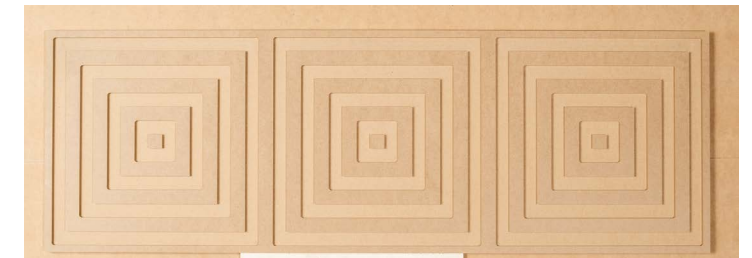

2085 INTERSQUARE PAINTABLE



2080 FLUTED PAINTABLE



8000 ACOUSTICAL HEX

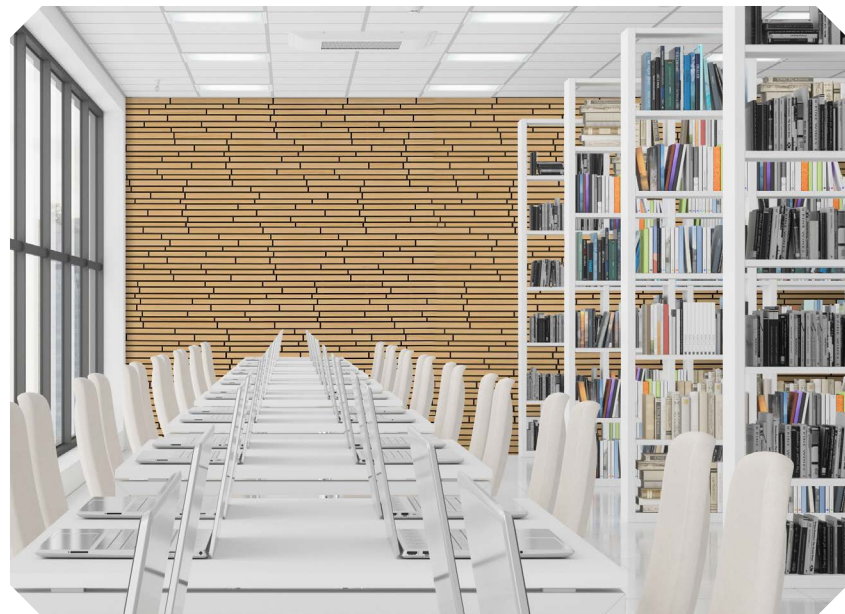

8002 ACOUSTICAL ARBOUR

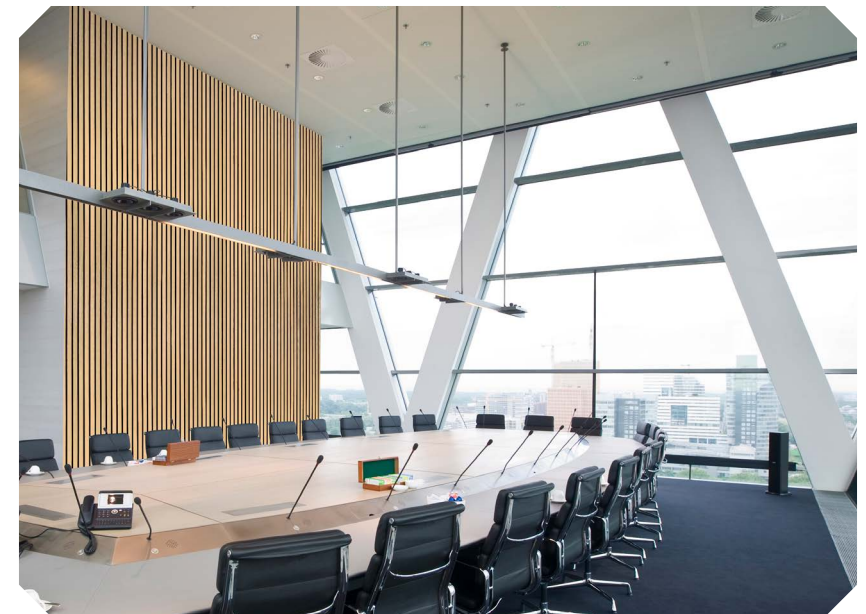

8001 ACOUSTICAL FLUTED

WIDTH/LENGTH
 Acoustical Arbour, Hex: 12.8" / 48"
 Acoustical Fluted: 12.8" / 96"

FINISH
 Acoustical Arbour, Fluted, Hex:
 10% U.V. Varnish with Antimicrobial Additive

SPECIES
 Acoustical Arbour, Fluted, Hex:
 White Oak with an MDF Core

COVERED AREA PER CASE
 Acoustical Arbour, Hex: 8.6 Sq.ft.
 Acoustical Fluted: N/A (Sold per Unit)

THICKNESS
 Acoustical Arbour, Fluted, Hex: 0.86"

NRC AND FIRE RATING
 Acoustical Arbour, Fluted, Hex:
 NRC 0.60 & Class A Fire

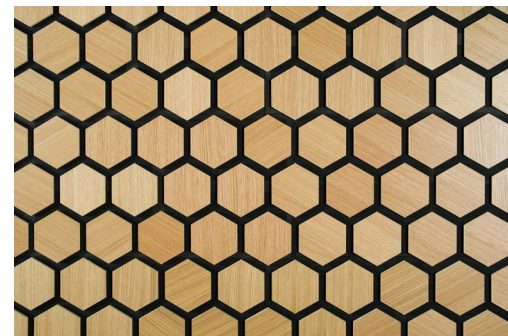

8000 ACOUSTICAL HEX

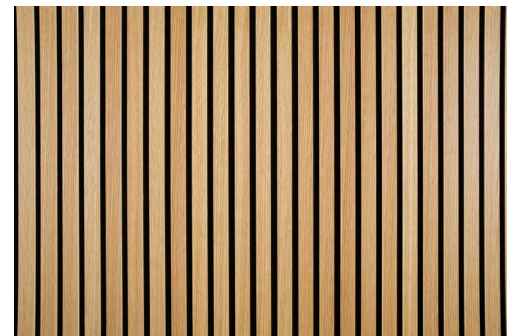

8001 ACOUSTICAL FLUTED



8002 ACOUSTICAL ARBOUR



2033 ZIG ZAG

FINISH
 Cubed, Incline, Slant, Vertex, Zig Zag:
 10% U.V. Varnish with Antimicrobial Additive

WIDTH/LENGTH
 Cubed: 17.14"/ 45.15"
 Incline and Vertex: 24"/ 24"
 Slant: 23.5"/ 23.5"
 Zig Zag: 16.05"/ 41.69"

SPECIES
 Cubed, Slant, Vertex: White Oak with a MDF Core
 Incline, Zig Zag: Walnut with an MDF Core

THICKNESS:
 Cubed, Incline, Slant, Vertex, Zig Zag: 0.28"

COVERED AREA PER CASE
 Cubed: 21.48 Sq.ft.
 Incline: 24 Sq.ft.
 Slant: 15.3 Sq.ft.
 Vertex: 24 Sq.ft.
 Zig Zag: 18.6 Sq.ft.

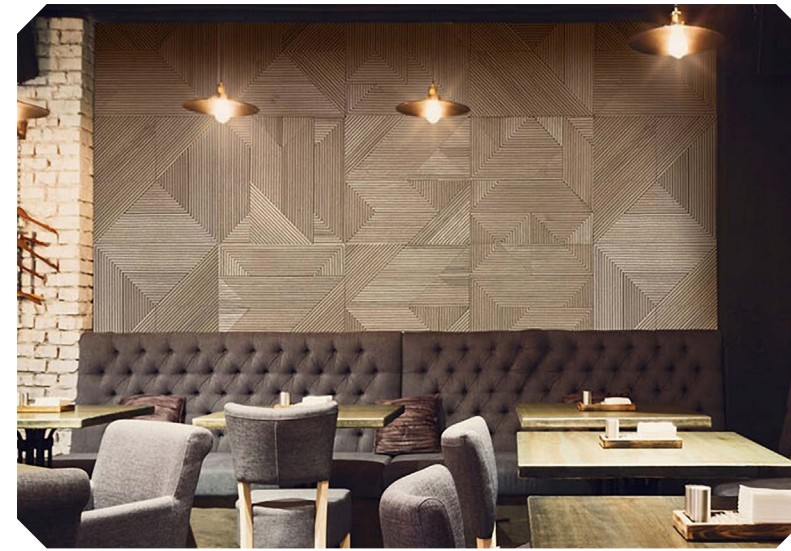

2034 VERTEX



2035 SLANT



2037 INCLINE



2032 CUBED

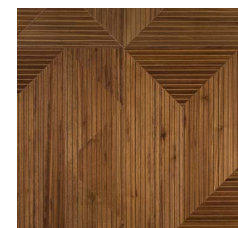

2037 INCLINE

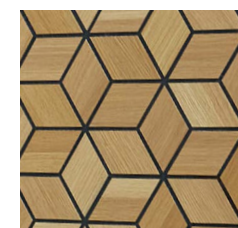

2032 CUBED

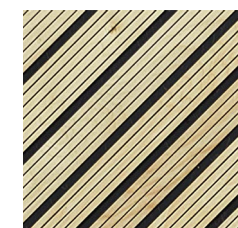

2035 SLANT



2034 VERTEX

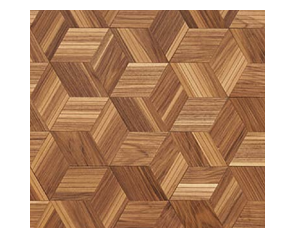

2033 ZIG ZAG

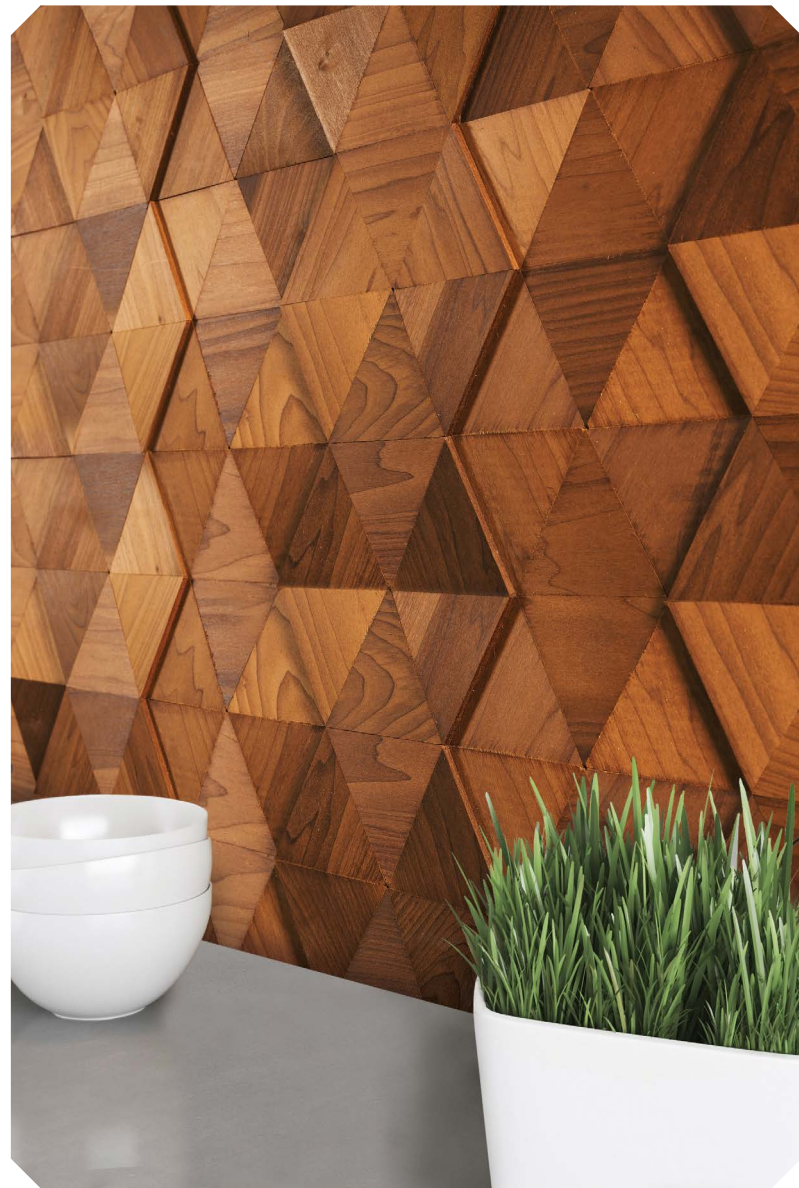

4422 RHOMBUS PLAY



8844 LOZENGE

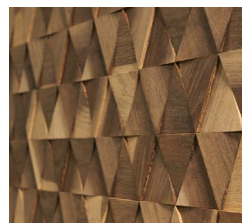

3313 POLYGON



8844 LOZENGE



O929 QUADRI

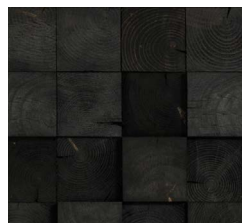

O929 QUADRI

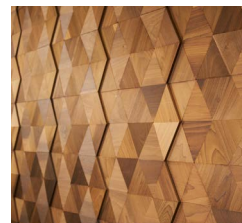

4422 RHOMBUS PLAY



3313 POLYGON

FINISH

Lozenge: 100% Natural Oil
 Polygon: 100% Natural Oil
 Quadri: 100% Natural Oil
 Rhombus Play: 100% Natural Oil

WIDTH/LENGTH

Lozenge, Polygon, Rhombus Play: 14"/ 48.5"
 Quadri: 11.25"/ 56.25"

SPECIES

Lozenge: White Oak
 Polygon: White Oak
 Quadri: Barn Wood
 Rhombus Play: Poplar

THICKNESS VARIATION:

Lozenge, Polygon, Rhombus Play: 0.26" and 0.47"
 Quadri: 0.71", 0.91" and 1.11"

COVERED AREA PER CASE

Lozenge, Polygon: 18.8 Sq.ft.
 Rhombus Play: 14.1 Sq.ft.
 Quadri: 8.8 Sq.ft.

WIDTH/LENGTH
13.44"/53.75"

COVERED AREA PER CASE
20 Sq. ft.

THICKNESS
0.59"

FINISH
Oak Weave: 100% Natural Oil
Walnut Weave: 100% Natural Oil

SPECIES
Oak Weave: White Oak
Walnut Weave: Walnut

2001 OAK WEAVE



2002 WALNUT WEAVE

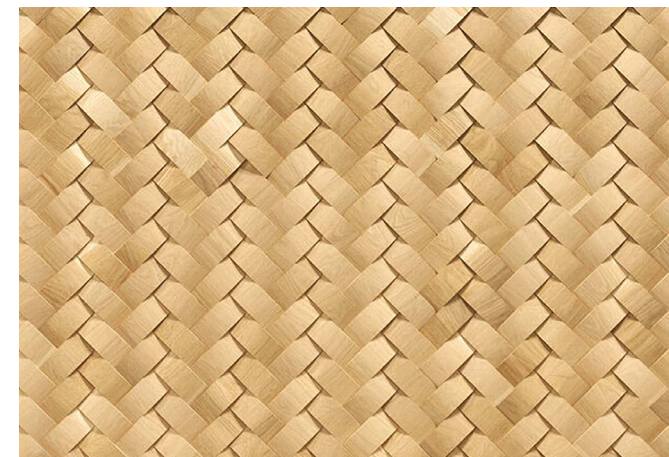

2001 OAK WEAVE

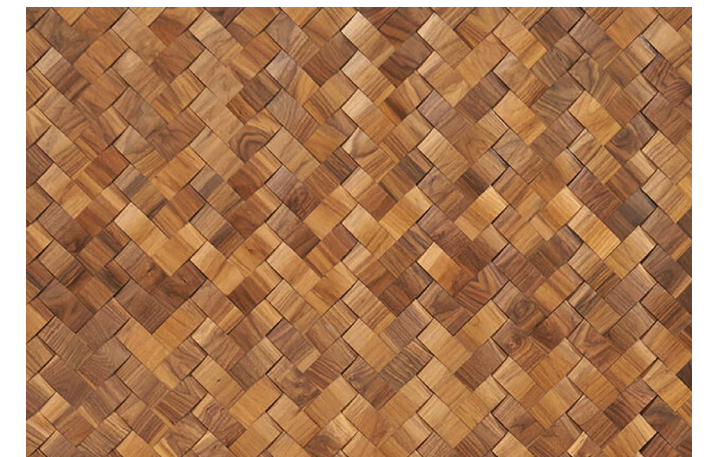

2002 WALNUT WEAVE

Our Teak Natural, Cloud, Coco RC is FSC-Certified, composed entirely of recycled wood from old homes and buildings from Indonesia. Through FSC-certification, we demonstrate our commitment to the environment.



6001 TEAK CLASSIC RP

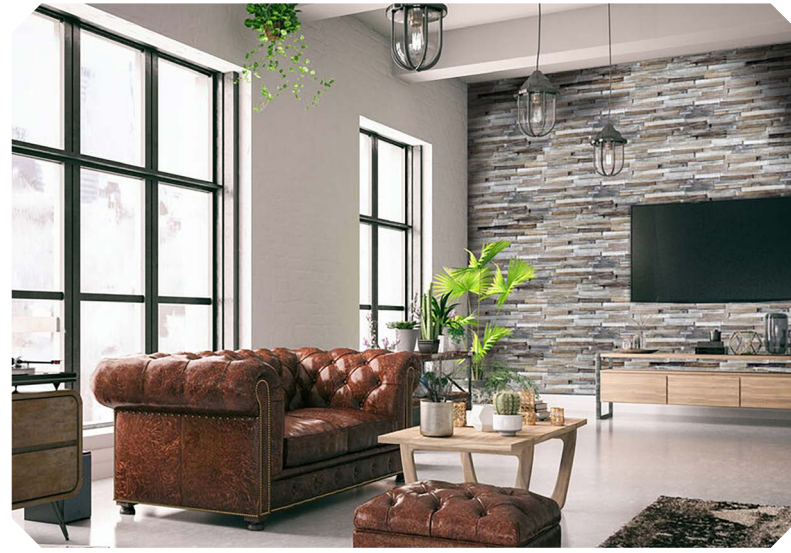

6003 TEAK CLOUD RC



6002 TEAK NATURAL RC

FINISH
 Teak Classic RP: Unfinished
 Teak Natural RC: Unfinished
 Teak Cloud, Coco RC: Pre-Stained

SPECIES
 Teak Classic RP: Recycled Teak
 Teak Natural RC: Recycled Teak
 Teak Cloud, Coco RC: Recycled Teak

COVERED AREA PER CASE
 Teak Classic RP: 10.8 Sq.ft.
 Teak Natural RC: 10.8 Sq.ft.
 Teak Cloud, Coco RC: 10.8 Sq.ft.

WIDTH/LENGTH
 Teak Classic RP: 8"/19.5"
 Teak Natural, Cloud, Coco RC: 8"/19.5"

THICKNESS VARIATION:
 Teak Classic RP : 0.25" and 0.85"
 Teak Natural, Cloud, Coco RC: 0.25" and 0.85"



6001 TEAK CLASSIC RP



6002 TEAK NATURAL RC



6003 TEAK CLOUD RC



6004 TEAK COCO RC



6007 ROOTWOOD BEACH

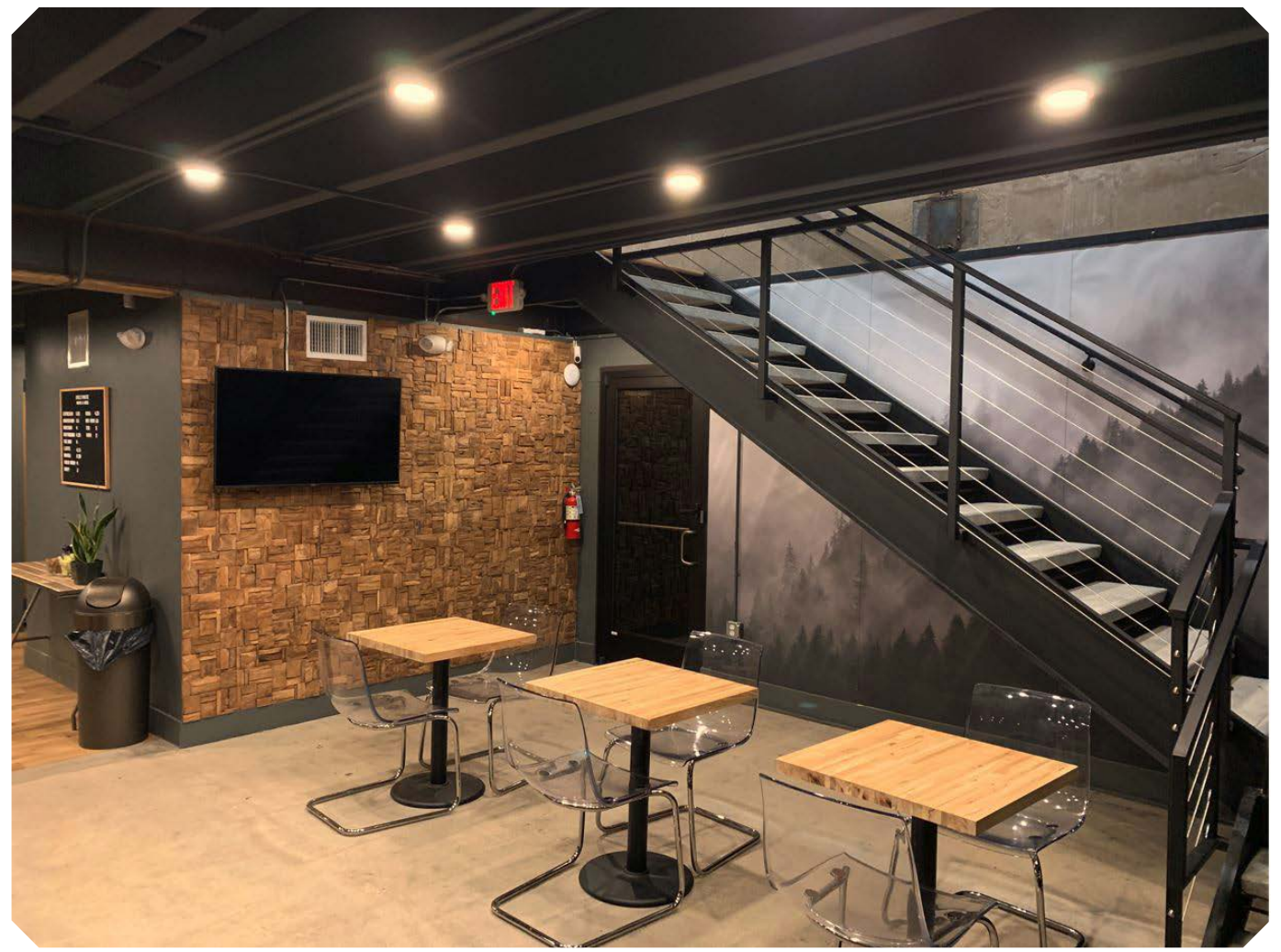

6005 ROOTWOOD NATURAL

FINISH
 Rootwood Beach, Dyed: Pre-Stained
 Rootwood Natural: Unfinished
 Branchwood Natural: Unfinished

SPECIES
 Rootwood Beach, Dyed, Natural:
 Repurposed Teak Root Wood
 Branchwood Natural: Repurposed Branch Teak Wood

COVERED AREA PER CASE
 Rootwood Beach, Dyed, Natural: 11 Sq.ft.
 Branchwood Natural: 10.8 Sq. ft.

WIDTH/LENGTH
 Rootwood Beach, Dyed, Natural: 9"/19.5"
 Branchwood Natural: 8"/19.5"

THICKNESS VARIATION:
 Rootwood Beach, Dyed, Natural: 0.25" and 0.85"
 Branchwood Natural: 0.25" and 0.85"

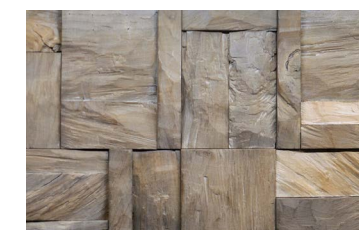

6007 ROOTWOOD BEACH

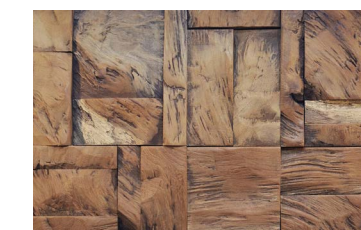

6006 ROOTWOOD DYED

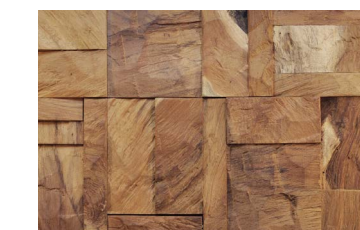

6005 ROOTWOOD NATURAL



6008 BRANCHWOOD NATURAL

WIDTH/LENGTH

Cellar: 14"/ 40"
Heraldry: 16.5"/ 59.5"
Origin: 18"/ 68"
Washed: 18"/ 68"

THICKNESS VARIATION

Cellar: 0.39" and 0.43"
Heraldry: 0.43" and 0.51"
Origin: 0.47" and 0.55"
Washed: 0.47" and 0.55"

COVERED AREA PER CASE

Cellar: 15.6 Sq. ft.
Heraldry: 27.2 Sq.ft.
Origin: 25.5 Sq.ft.
Washed: 25.5 Sq.ft.

FINISH

Cellar: No Finish
Heraldry: No Finish
Origin: No Finish
Washed: 10% U.V. Varnish

SPECIES

Barn Wood

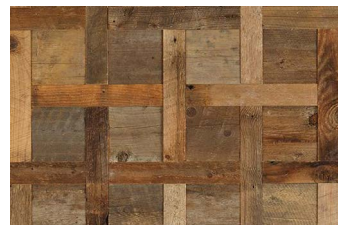

O903 CELLAR



2022 WASHED



O101 HERALDRY



2021 ORIGIN



O903 CELLAR



O101 HERALDRY



2022 WASHED



2021 ORIGIN



8537-2 SPRINGFIELD

WIDTH/LENGTH
14" / 44"

COVERED AREA PER CASE
17 Sq. ft.

THICKNESS VARIATION
0.28" and 0.35"

FINISH
Lahinch, Springfield:
10% U.V. Varnish with Antimicrobial Additive
Vision: Unfinished

SPECIES
Lahinch: Birch
Springfield: Birch
Vision: Birch



5242-2 LAHINCH



8537-2 SPRINGFIELD



7512-2 VISION



5242-2 LAHINCH

WIDTH/LENGTH
14"/57"

THICKNESS VARIATION
0.28" and 0.35"

COVERED AREA PER CASE
22 Sq. ft.

FINISH
Antiqued: 100% Natural Oil
Juglans: Varnish 10% Gloss
with Antimicrobial Additive

SPECIES
Antiqued: White Oak
Juglans: Walnut



2012 JUGLANS

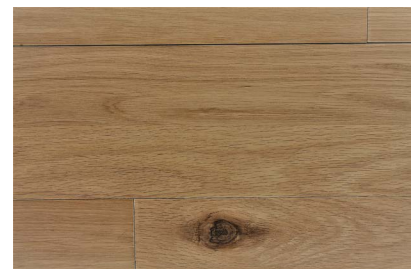

4796 ANTIQUED



4796 ANTIQUED



2012 JUGLANS



O318 BARN

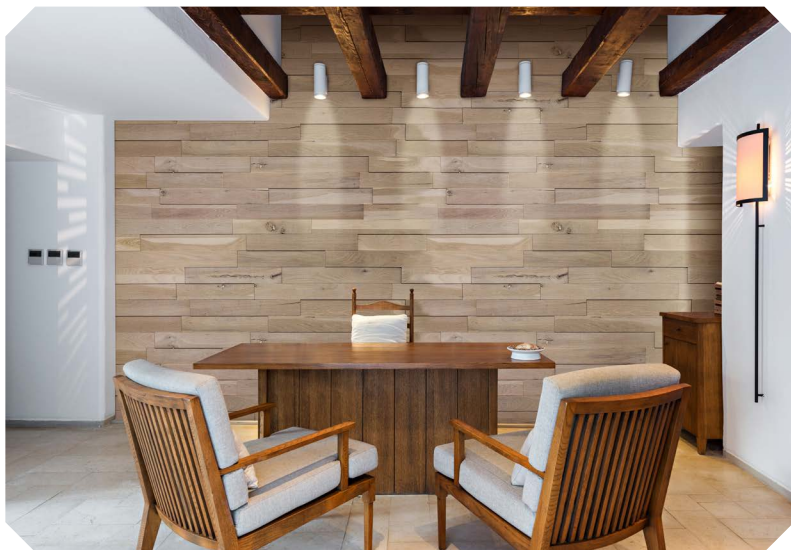

3812 BEACH

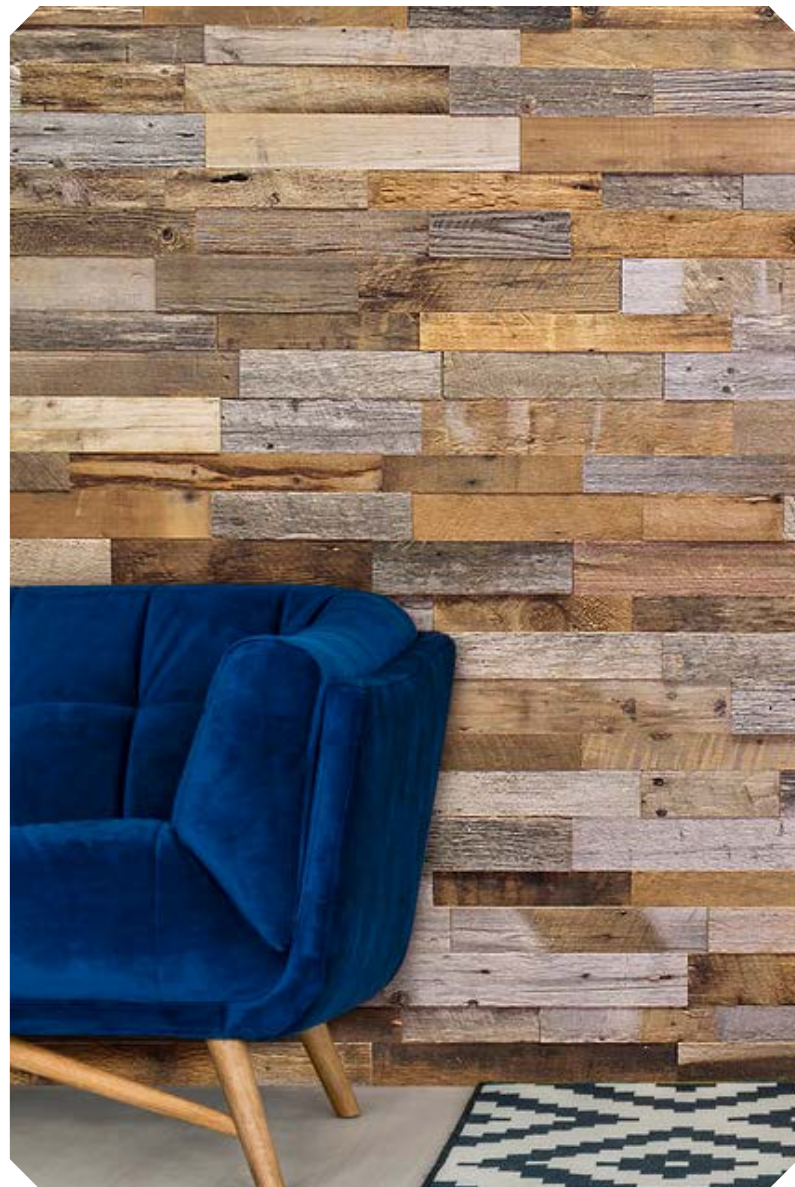

I231 NATURAL

FINISH
 Andover, Beach: 100% Natural Oil
 Barn: Varnish 10% Gloss with Antimicrobial Additive
 Natural: No Finish

WIDTH/LENGTH
 Andover, Barn, Beach: 14"/ 47"
 Natural: 14"/ 44"

SPECIES
 Andover, Beach: White Oak
 Barn: Walnut
 Natural: Barn Wood

THICKNESS VARIATION:
 Andover, Barn, Beach: 0.43" and 0.51"
 Natural: 0.47" and 0.55"

COVERED AREA PER CASE
 Andover, Barn, Beach: 18.2 Sq.ft.
 Natural: 17 Sq.ft.

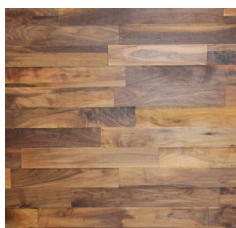

O318 BARN



3812 BEACH

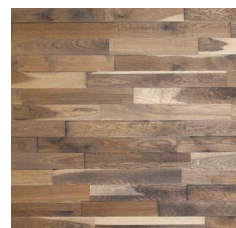

2590 ANDOVER



I231 NATURAL



O310 NANAVUT

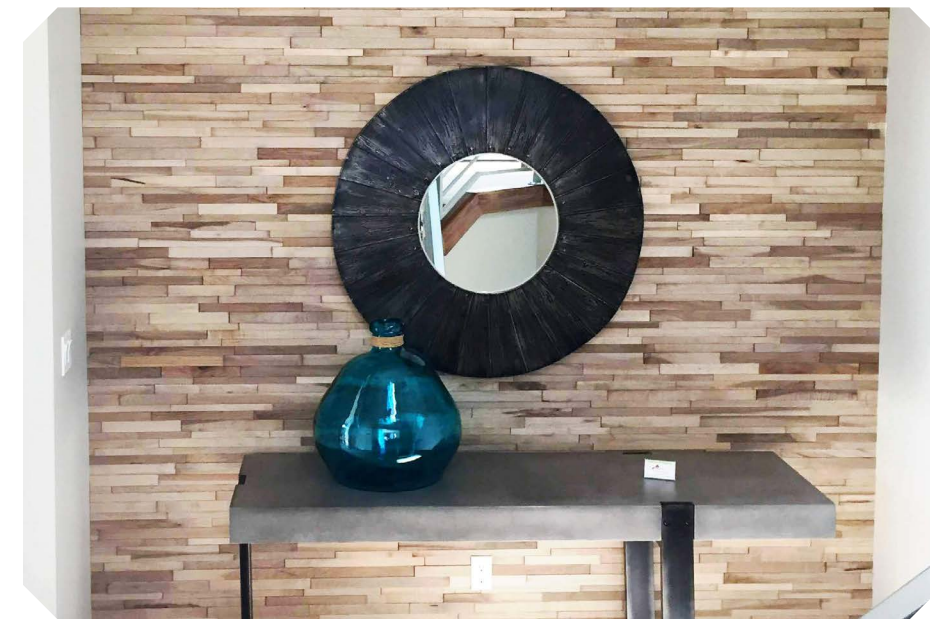

1012 YUKON

WIDTH/LENGTH
13.5"/53.5"

THICKNESS VARIATION
0.19", 0.26" and 0.31"

COVERED AREA PER CASE
30 Sq. ft.

FINISH
100% Natural Oil

SPECIES
Nanavut: Red Oak
Niagara: White Oak
Yukon: Maple



9130 NIAGARA

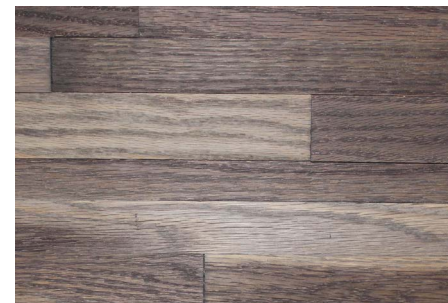

O310 NANAVUT



1012 YUKON

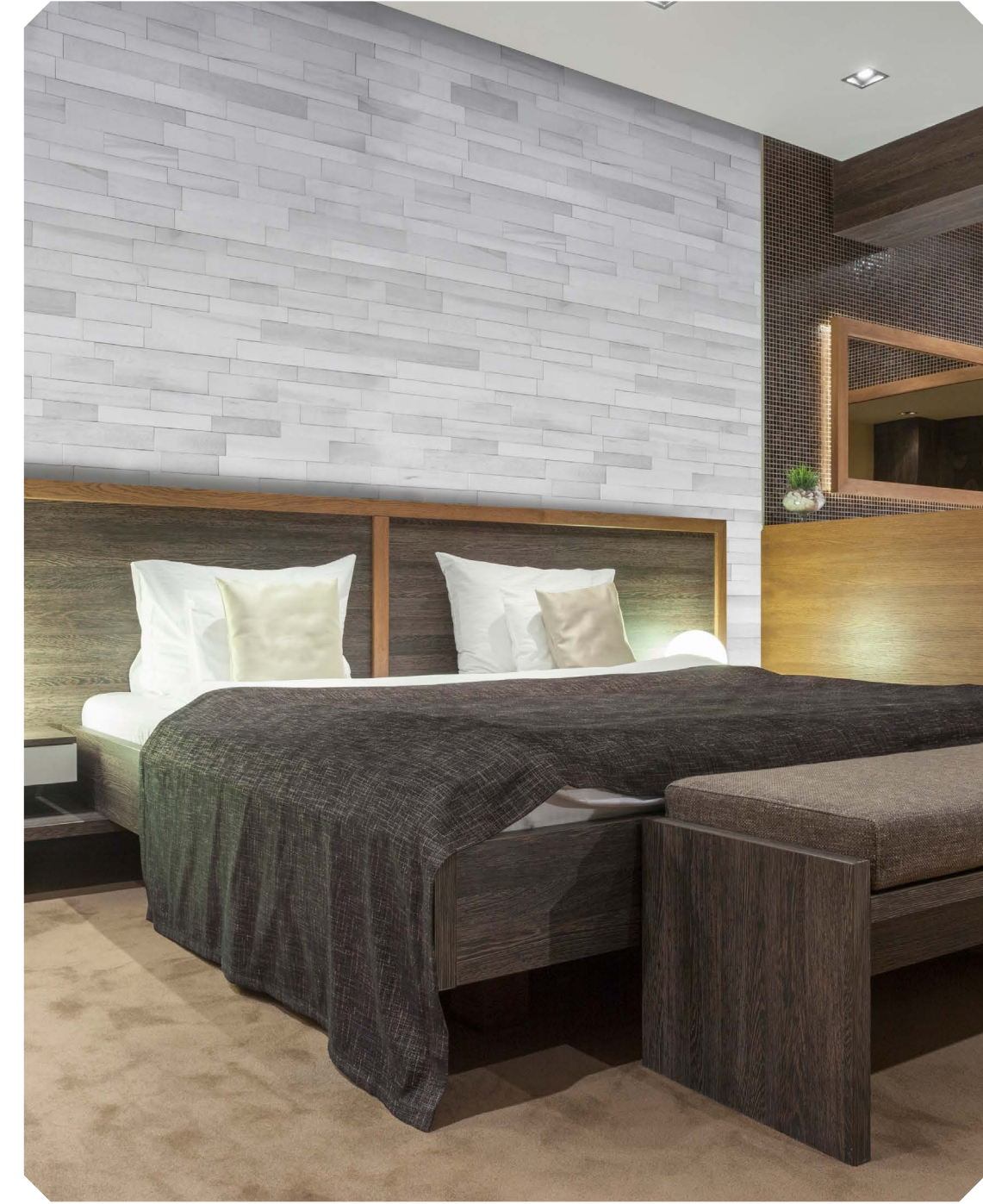

WIDTH/LENGTH
14"/44"

THICKNESS VARIATION
0.33" and 0.39"

COVERED AREA PER CASE
17 Sq. ft.

FINISH
Varnish 10% Gloss with
Antimicrobial Additive

SPECIES
Maple



OIII ADVENT



O429 LOBO

OIII ADVENT

O429 LOBO



1223 ALBERTA



1223 ALBERTA



0602 BRITISH COLUMBIA



0530 MANITOBA



0530 MANITOBA

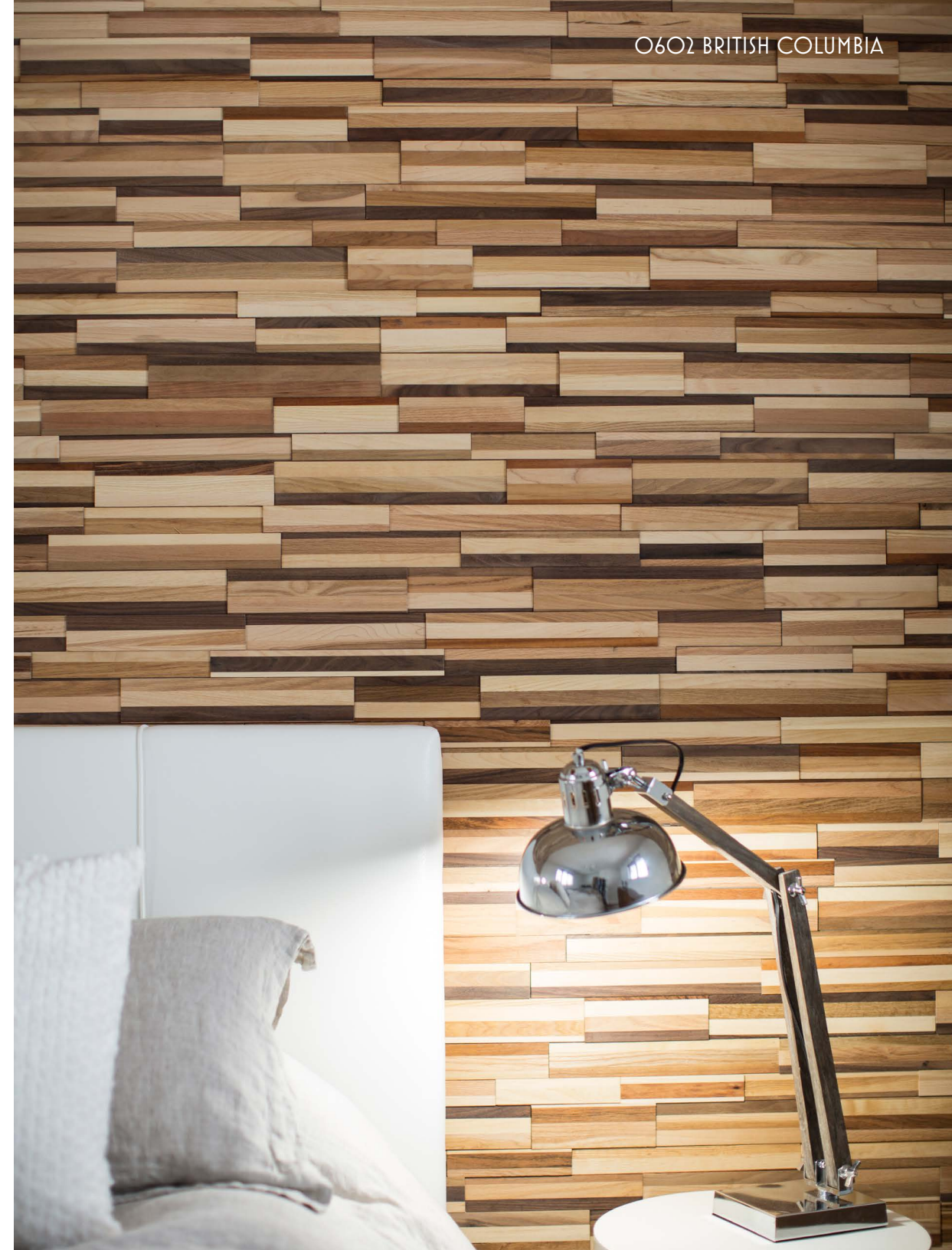

0602 BRITISH COLUMBIA

WIDTH/LENGTH
12" / 60"

THICKNESS VARIATION
0.35" and 0.43"

COVERED AREA PER CASE
25 Sq. ft.

FINISH
100% Natural Oil

SPECIES
Mix of Hardwood Species

Due to the nature of the product as a unique and organic material, imperfections and variations in wood grain and color may vary from samples.



1105 PRINCE EDWARD



1105 PRINCE EDWARD

WIDTH/LENGTH
13.5"/53.5"

SPECIES
Walnut

COVERED AREA PER CASE
30 Sq.ft.

THICKNESS VARIATION
0.19", 0.26" and 0.31"

FINISH
Varnish 10% Gloss with Antimicrobial Additive

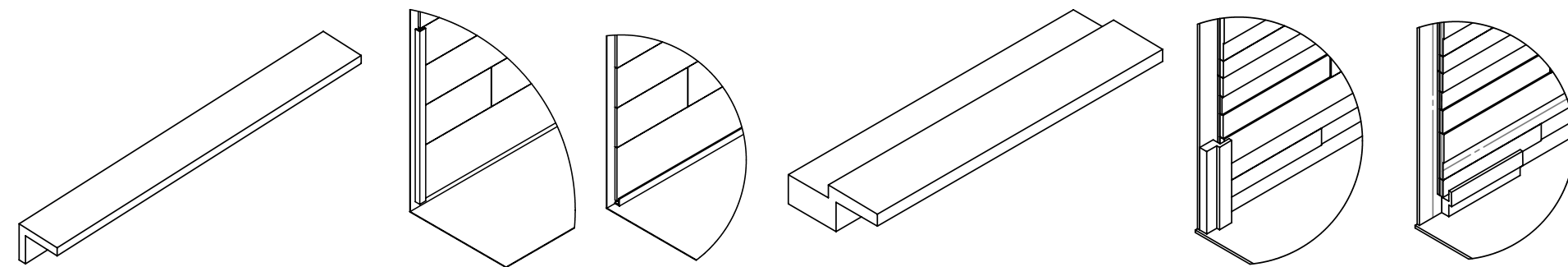

Trim Pieces

Corner and Contour Moldings

Design is in the details. You can customize your look by installing our decorative panels wall to wall or with corner or contour molding. Our trim is sold in 90" pieces; availability varies based on species and wall panel. Please contact your sales representative today for more information.



Customization

Limitless Design Options

We have extensive experience taking conceptual designs and quickly translating them into prototypes and tangible products. That's a huge advantage for designers and architects. We act as a facilitator, knocking down barriers one by one so nothing stands in the way of your creative process.

We Bring Your Ideas to Life

Products can be personalized or fully customized. Can't find the exact design or finish you want in our collections? When creativity calls, we're there every step of the way. Take advantage of our clever, artistic approaches as we guide you through a fast, personalized development process that takes into account your creative vision.

Quick Mock-Ups

You need to know your idea will work, and you need to know now. One of the things architects and designers appreciate about working with Stacked Wood is our ability to develop mock-ups in short order, helping streamline your creative process.



CUSTOM WHITE



CUSTOM HICKORY

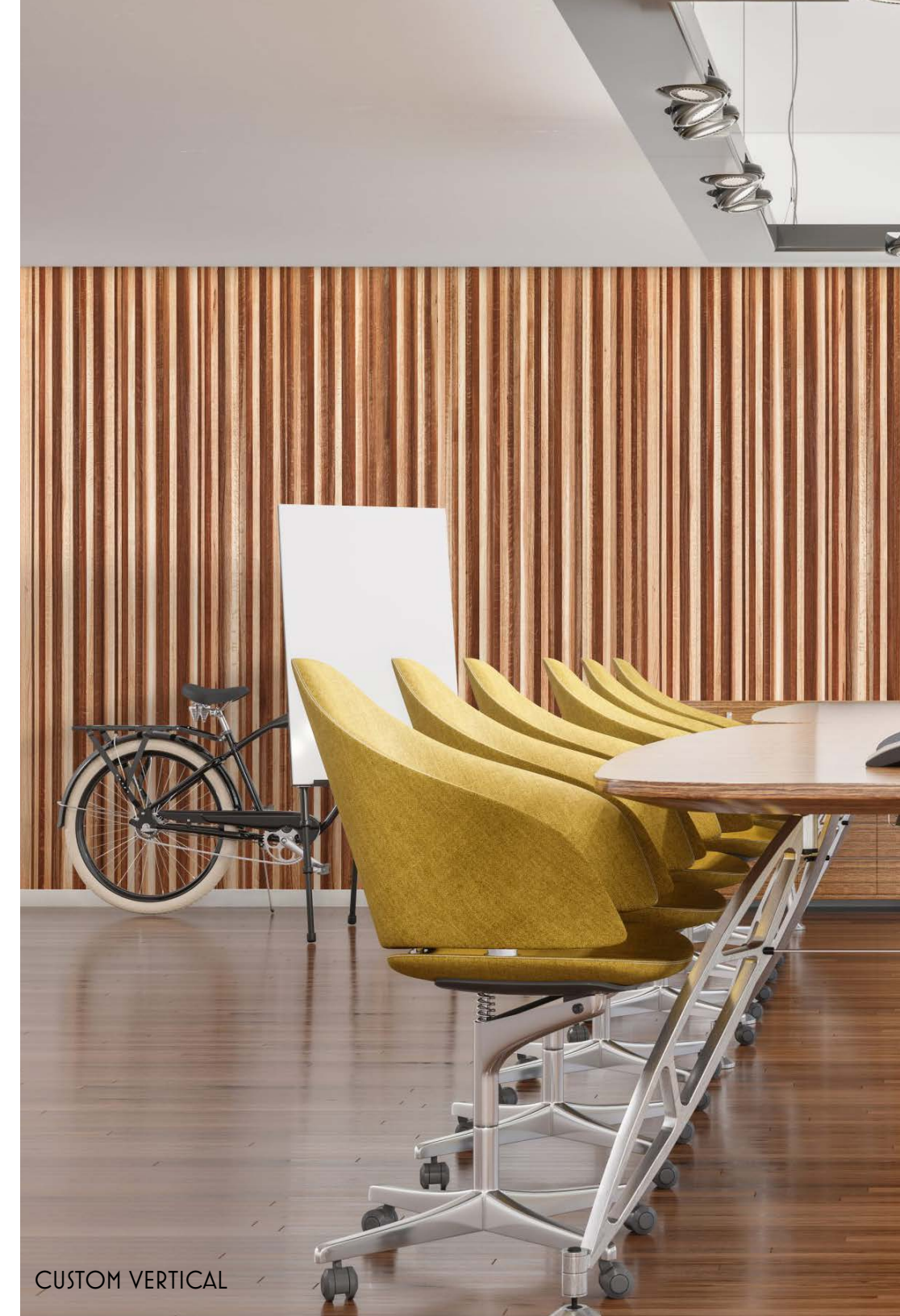

CUSTOM VERTICAL

Tailor Made Process



CHOOSE FROM ITEMS THAT ARE EASILY MADE FOR YOU IN OUR TAILOR MADE SELECTION, IT IS A DIFFERENT WAY TO ORDER STACKED WOOD WALLS.

WE HAVE SHEETS READY TO GO FOR YOUR DESIGN NEEDS.

Select Your Design

Select one of six design options to start the Tailor Made process.

Choose Your Wood

Select either Walnut or White Oak as your wood species.

Select Your Finish

Choose from 10% Varnish finish with an added antimicrobial or 100% Natural Oil.

Ship Time

Once your order is processed your order will be available to ship in five to seven business days.

DESIGN OPTIONS

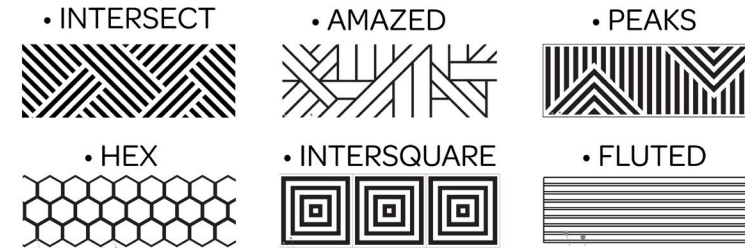

WOOD OPTIONS



FINISH OPTIONS

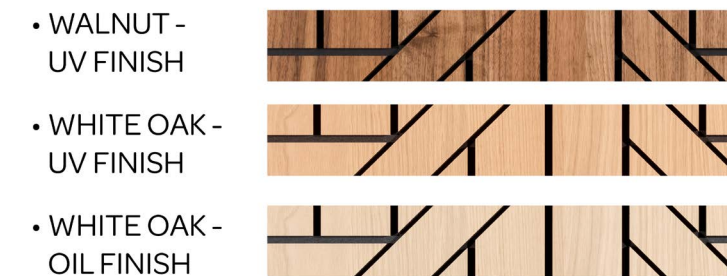

HEX OAK - OIL

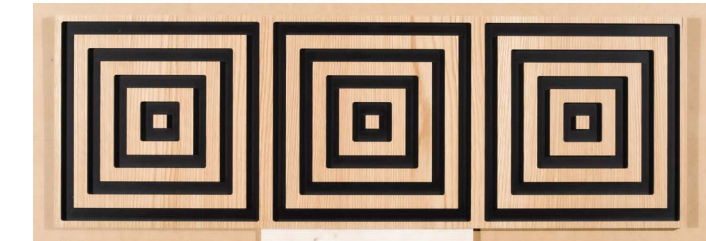

INTERSQUARE OAK - OIL



AMAZED OAK - OIL







FLUTED OAK - OIL



INTERSECT OAK - OIL

SUMMARY

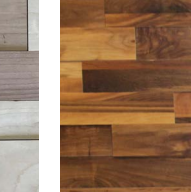
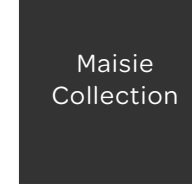
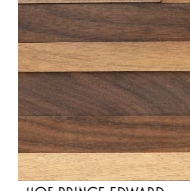
Acoustical Collection	Expressive Collection	Geometry Collection	Naturel Collection	New Era Collection	Paintable Collection	Premier Collection	Reclaimed Collection	Statement 2.0 Collection	Vintage Collection	Vintage 2 Collection					
 8000 ACOUSTICAL HEX	 0602 BRITISH COLUMBIA	 8844 LOZENGE	 2035 SLANT	 2033 ZIG ZAG	 1012 YUKON	 2036 FLUTED OAK	 2090 FLUTED WALNUT	 2080 FLUTED PAINTABLE	 2086 PEAKS PAINTABLE	 2001 OAK WEAVE	 6001 TEAK CLASSIC RP	 6005 ROOTWOOD NATURAL	 5242-2 LAHINCH	 1231 NATURAL	 0903 CELLAR
 8001 ACOUSTICAL FLUTED	 0550 MANITOBA	 3313 POLYGON	 2032 CUBED	 2037 INCLINE	 0310 NANAVUT	 2038 INTERSECT OAK	 2091 INTERSECT WALNUT	 2081 HEX PAINTABLE	 2085 INTERSQUARE PAINTABLE	 2002 WALNUT WEAVE	 6002 TEAK NATURAL RC	 6006 ROOTWOOD DYED	 8537-2 SPRINGFIELD	 3812 BEACH	 0101 HERALDRY
 8002 ACOUSTICAL ARBOUR	 1223 ALBERTA	 0929 QUADRI	 4422 RHOMBUS PLAY	 2034 VERTEX	 9130 NIAGARA	 2095 HEX OAK - OIL	 2092 HEX WALNUT	 2082 INTERSECT PAINTABLE	 Satine Collection	 6003 TEAK CLOUD RC	 6007 ROOTWOOD BEACH	 7512-2 VISION	 0318 BARN	 2021 ORIGIN	 2022 WASHED
 Premier Collection	 0111 ADVENT	 0429 LOBO	 Maisie Collection	 4796 ANTIQUED	 2012 JUGLANS	 2031 AMAZED OAK	 2094 AMAZED WALNUT	 2084 AMAZED PAINTABLE	 1105 PRINCE EDWARD	 6004 TEAK COCO RC	 6008 BRANCHWOOD NATURAL	 2590 ANDOVER	 2590 ANDOVER	 2022 WASHED	 2022 WASHED
						 2095 INTERSQUARE WALNUT	 2096 PEAKS WALNUT								

stackedwoodwalls.com

Due to the nature of the product as a unique and organic material, imperfections and variations in wood grain and color may vary from samples.



PROUDLY DISTRIBUTED BY:



721 2nd Avenue North, Minneapolis, MN 55405
P: 800-358-6332 • designresource-midwest.com



2275 Auto Centre Drive, Glendora, CA 91740
P: 800-472-7891 • lbiboyd.com



30600 Aurora Road, Suite 110, Solon, OH 44139
P: 800-362-9930 • fashionadco.com

Front Cover: 2090 Fluted Walnut
Back Cover: 2037 Incline

Please contact your area representative for more information or samples.

Please visit stackedwoodwalls.com to obtain the correct installation instructions per species.



STACKEDWOODWALLS.COM