

LELAND

# Price List

## January 2023



Pricing Effective: January 2023

**January 2023 Pricelist**

Terms & Conditions: Table of Contents	2
Ordering Information	4
Terms, Conditions & General Information	6
Freight Program	9

<b>Amadeus Pricelist</b>	AM
<b>Baraga Pricelist</b>	BA
<b>Brit Bench Pricelist</b>	BBM
<b>Cambre Table Pricelist</b>	CA
<b>Café Parfait Pricelist</b>	CP
<b>Ease Pricelist</b>	ES
<b>Ebb Fully Upholstered Bench Pricelist</b>	EB
<b>Fast Table Pricelist</b>	FT
<b>Fixed Table Pricelist</b>	FXT
<b>Fly Table Pricelist</b>	FLY
<b>Hammok Pricelist</b>	HS
<b>Handy Stool Pricelist</b>	HA
<b>Leah Table Pricelist</b>	LT
<b>M2 Seating Pricelist</b>	M2S
<b>M3 Table Pricelist</b>	M3T
<b>Marquette Pricelist</b>	MQ
<b>Mass Chair Pricelist</b>	MA
<b>Omena Pricelist</b>	OM

<b>Parfait II Pricelist</b>	P11
<b>Pluto Bench Pricelist</b>	PB
<b>Quarry Pricelist</b>	QR
<b>Rapson Forty-Eight Chair Pricelist</b>	RP48-C
<b>Rapson Thirty-Nine Bench Pricelist</b>	RP39-B
<b>Rapson Thirty-Nine Guest Pricelist</b>	RP39-G
<b>Rapson Thirty-Nine Lounge Pricelist</b>	RP39-L
<b>Slam Pricelist</b>	SL
<b>Slam Beam Pricelist</b>	SB
<b>Valeri Pricelist</b>	VS

## Orders

All orders must be submitted in writing either by fax or e-mail. Specify each item by its product code and the corresponding model description, finish, upholstery and options offered in the price list. If the customer's current product order must match a previous order, Leland International must be notified. A sample product from the original order must be submitted at the expense of the customer to assure uniformity of finish and construction. Orders with missing or incorrect information such as model, finish, color, pricing, etc. will be scheduled upon receipt of correct and complete information.

Leland products are specified for and installed in a variety of end user applications. It is the responsibility of the purchasing party to understand the end user's intent and purchase products appropriate for that application. Leland takes no responsibility for incorrect specifications. Acceptance and fulfillment of any purchase order does not imply that the product is suitable for a certain application. Leland will only warranty products that have been installed in applications for which they were designed.

If multiple delivery schedules are required, the customer must submit separate purchase orders for each delivery date.

## Acknowledgement

Orders are only accepted by issuance of our formal acknowledgment. It is the purchaser's responsibility to check acknowledgements and invoices for accuracy. If there is any discrepancy, the customer must notify Leland International within 72 hours. Failure to notify Leland International within this time period will constitute acceptance of the order as acknowledged, and our acknowledgment is final and binding.

All acknowledgments will contain an estimated ship date. If for some reason the furniture must not ship earlier than the estimated ship date, please specify a "Do not ship before date" in your purchase order. We are not responsible for delays in scheduling or failure to make scheduled ship date due to strikes, lockouts or other labor complications, war, riots, Acts of God, fires, accidents, restraints affecting shipment or credit, reduced supply or excessive cost of fuel or raw material, delays from suppliers, compliance with government regulations or other unforeseen contingencies.

## Wood Finishes

Wood finishes can be light sensitive; therefore, care should

be taken to avoid placing chairs in areas exposed to intense natural light. Due to variations common to all wood species,

the color and grain characteristics of the finish samples may not exactly match that of the finished product. Custom finishes must meet factory approval and are subject to a \$100.00 minimum net mixing charge. Please allow up to three weeks to prepare the custom wood finish match sample. Orders will not be scheduled or acknowledged until finish match approval is received in writing.

Due to limitations of the raw materials and the natural background color of wood, not all colors can be successfully reproduced. The suitability of a color for custom finish matching cannot always be determined beforehand. This is especially true in the case of custom colors submitted on non-wood products. If we are unable to produce a commercial match to your custom color, you will be notified at the earliest possible date, and no charge will be levied.

## Laminates

The following laminates with the manufacturers noted are considered to be standard and are usually in stock.

### FORMICA®

[www.formica.com/en/us/trade-products](http://www.formica.com/en/us/trade-products) or call 800.367.6422

Select solid colors, wood grains or patterns  
Select number/name  
Select standard finishes  
Laminates with -58 (matte finish) are standard

### WILSONART®

[www.wilsonartcontract.com/pattern-availability/](http://www.wilsonartcontract.com/pattern-availability/)  
or call 800.433.3222

Select laminate finish,  
Select Leland standard finish -38 (fine velvet texture)  
or -60 (matte)

### PIONITE®

[www.pionite.com/pionite/pages\\_pionite/pionite\\_colors.html](http://www.pionite.com/pionite/pages_pionite/pionite_colors.html)  
or call 800.746.6483

Select colors



**Customer's Own Information (COM)**

Leland International reserves the right of preliminary approval of all COM, prior to order acceptance. Even after such preliminary approval, Leland International reserves the right to reject COM if, upon physical inspection of the COM, it proves unacceptable for use on Leland International products. When this occurs, the customer will be notified in writing with an explanation of the problem. A written release from the customer will be required for the order to be processed.

It is recommended that all COM textile be tested for compatibility with Leland's products prior to sending COM to Leland for application. Please contact Customer Experience to request the COM Approval Form with instructions for COM submittal.

Choosing not to have COM textile tested for compatibility may result in the COM being rejected at the expense of the customer.

Leland International cannot assume responsibility for durability, appearance or other qualities of customer's own material on the finished product and does not give any warranty with respect to COM. At Leland International's discretion,

additional yardage, labor charges, or handling surcharges may be required as a condition of COM acceptance. COM delivered to Leland International without proper identification may be refused, and Leland International shall have no responsibility for loss or any other claims. Excess textile will not be returned unless specifically requested in writing.

Please contact the Leland Customer Experience Department for yardage requirements on all COM textiles which are patterned or narrower than 54 inches wide.

Orders using COM may be rescheduled if the COM has not been received two (2) weeks prior to the original ship date. Every effort will be made to avoid a delay and to complete the customer's order within the standard lead time.

All shipments of COM to Leland International must be sent prepaid. COM should be sent to:

LELAND INTERNATIONAL  
5695 Eagle Drive SE  
Grand Rapids, Michigan 49512

COM packages must include the following information:

- Name of customer

- Purchase order number to which the material is to be applied and Leland Sales Order, if known.

Purchase orders specifying COM must include the following:

- Indicate which side of the textile is to be exposed (manufacturer's implied face will be used if no side is indicated by the customer).
- If textile is a stripe or pattern, specify vertical or horizontal upholstered application (textile will be applied off the bolt if no direction is indicated by the customer).
- COM suppliers' name, textile number and quantities of pieces to which the material is to be applied.

**California Technical Bulletin 133 [TB 133]**

TB 133 is a full scale fire performance test of complete articles of seating furniture. Some Leland International products in combination with a variety of upholstery textiles have been tested and are in compliance with TB 133. Test documentation is available upon request. If you wish to specify Leland products that have not been tested for compliance with TB 133 please consult Leland Customer Experience Department for TB 133 testing cost information.

In order for Leland products to comply with TB 133 the foam must be protected with a fire blocker or a special fire retardant foam must be used. For those products that must comply with TB 133 there will be a net charge per chair for fire blocker laminating or fire retardant foam. Please contact Leland International for a CAL 133 quotation on all seating.

Since TB 133 tests furniture and not components, there are no TB 133 approved textiles. Textiles comprised solely or in any combination of the following fibers are more likely to be suitable components for chairs that must comply with TB 133.

- |                |              |           |
|----------------|--------------|-----------|
| Acrylic        | Nylon        |           |
| Vinyl          | Animal Hairs | Polyester |
| Wool           |              | Virgin    |
| Cordura        | Rayon        |           |
| Viscose        | Cotton       |           |
| SEF Modacrylic | Wool         |           |
| Leather        | Silk         |           |
| Worsted Wool   | Modacrylic   |           |
| Spun Nylon     | Mohair       |           |
| Trevira        |              |           |

---

## Prices

All prices are list prices F.O.B. our factory in Grand Rapids, Michigan 49512. Our pricing includes packing and corrugated cartoning for common carrier shipments. List prices do not include freight, storage, taxes or additional packaging required for certain carriers and are subject to change without notice.

We reserve the right to change quotation prices prior to acceptance by the buyer. Quotation prices must be accepted within 30 days unless otherwise specified in writing on the quotation. Pricing on orders specifying shipment 90 days or more after the formal date of acknowledgment will be based on pricing prevailing at time of shipment.

---

## Resale Rights

Leland International reserves the right to reject any order placed by any customer for any reason, irrespective of whether orders have been previously accepted from such customer, without incurring liability to such customer. No customer shall have a continuing right to buy products from the company except pursuant to a formal dealer agreement or other written agreement covering future supply executed by the company and the reseller. Distribution of the price list or catalog does not itself constitute an offer to sell.

---

## Credit and Payment Terms

An open account may be established for new customers. One bank and three trade references will be required and must be faxed to Leland International, attention:

Accounting. Credit will be established upon review and approval of your application.

Allow up to four weeks delay for credit approval. To avoid this delay, orders on new accounts must be accompanied by a 50% deposit. If credit is approved by the time the order is ready for shipment, the balance must be paid within terms. Accounts that are inactive for a twelve month period will automatically be closed and are subject to the above conditions for new accounts. Leland International may change or cancel credit at its discretion and may request advance payment at any time.

Upon establishment of an open account, terms are "Net 15 Days" after date of invoice with a credit limit established on a per customer basis. 1½% per month service charge will be added to all past due accounts. Orders will not be processed for past due accounts until the amount due, including any

service charge, is paid in full. All custom orders will require a down payment of 50% and will not be scheduled for production until the down payment is received.

Leland International reserves the right to revoke the terms of any customer at any time for any reason.

Orders for customers that have pre-paid terms require payment in full in (7) seven business days prior to the scheduled ship date. Payment not received by this day may result in the order being rescheduled.

---

## Changes and Cancellations

Orders are not subject to change or cancellation without factory approval. Leland International will make every reasonable effort to stop production scheduling, shipment, etc., upon receipt of written notification of changes, cancellations or deferments stipulated as follows. Approved cancellations, changes, and delivery date extensions may be subject to charges.

---

## Cancellations

Cancellations received prior to production will be assessed a \$100 net cancellation charge. Cancellations received after production has been started will be assessed the total accumulated cost of the project plus a \$100 net cancellation charge.

---

## Deferred Shipments

If the order is complete or in the production cycle, charges will be assessed from the completion date in accordance with policy for "Storage by the Manufacturer."

---

### Storage by the Manufacturer

If the customer cannot accept delivery when merchandise is ready, according to the terms of our acknowledgment, we reserve the right to transfer goods to storage at the customer's expense, and the order will be invoiced at the time of storage. Payment of this invoice will be due on the original terms given to the customer. Storage charges and freight charges for delivery will be invoiced separately upon release of the merchandise from storage and will be due upon receipt of the invoice. Orders put into storage require payment in full and all incurred storage charges must be paid prior to the order being shipped.

---

### Shipping

We will ship in accordance with the customer's written instructions. If customer omits specific shipping instructions, we will ship in the manner that we consider to be the best way. All shipments are sent F.O.B. Grand Rapids, Michigan 49512. Leland International's liability ends when received by the carrier at Leland International's dock. Title of the goods and risk of loss transfers to the buyer at that time. Freight shall be paid by the buyer unless otherwise acknowledged in writing by Leland International. We make every effort to ship orders complete and on schedule. We reserve the right to make partial shipments as merchandise is ready. Failure to deliver all the merchandise at one time does not relieve the customer of the obligation to accept and pay for merchandise received.

---

### Damage Claims

All Leland International products are thoroughly inspected prior to shipment from our factory and packed to comply with carrier requirements. Customers must carefully inspect all items upon arrival and note any damage on the delivery receipt. Phrasing such as "Subject to Inspection" does not constitute a note of damage and will not be accepted as grounds for honoring a freight claim. A written claim must be filed within 15 days of receipt with the carrier if any obvious or subsequent

concealed damage is discovered and still does not guarantee the honoring of freight claim. Caution: When a clear receipt is obtained by a carrier, Leland International, nor the carrier, are any longer responsible for damages or shortages. Processing claims for damage and shortages are the responsibility of the buyer unless otherwise specified in writing by Leland International. At no time can claims be deducted from our invoices.

---

### Delivery Charges

Charges incurred by Leland International complying with any non-standard shipment request such as inside delivery, expediting, redelivery, weekend delivery, unpacking, straight trucks, specific driver requests, or temporary holding will be invoiced to the purchaser.

---

### Storage by Owner

Due to the inherent nature of wood products, we cannot guarantee any product stored or set in place in an environment where temperature and humidity are not controlled. Temperatures must be maintained within a range of 50°-80° F (10°-27° C); the relative humidity must be maintained between 25% and 40%. These conditions are also recommended for human health standards.

---

### Product Discrepancy

Errors in products including color, size, other variations, or missing components must be reported to Leland International within thirty (30) days of delivery. Failure by the purchaser to report any product inaccuracies within thirty (30) days of delivery shall constitute acceptance of the product.

---

### Miscellaneous

All costs for furniture installation, removal from service and reinstallation due to damage claims, partial shipments, shipping errors or warranty claims is the responsibility of the customer. Leland International will not be liable for costs associated with any of the above conditions.

Sizes and weights are considered to be approximate. Leland International reserves the right to make changes in design and construction or discontinue products without notice. Due to conditions beyond our control all wood products, textiles and vinyls are subject to variations in color, texture and grain.

Price list specifications supersede all other specifications whether verbal or written, and may not be altered without the written consent of an officer of Leland International. All clerical errors on any agreement, publication, correspondence, price list, or product literature pieces are subject to correction at any time.

## MAINTENANCE

---

Since chairs and tables are installed and used under a variety of conditions, users must make inspections no less than every six months to look for damage or signs of structural fatigue incurred in daily handling, use and abuse. Examinations must include welds, machine screw assemblies and the shell to base fasteners. If problems are discovered that could compromise the structural safety of a chair, it should be immediately removed from service and Leland International should be notified. Coats and other articles should not be hung on the back of chairs. This practice may cause chairs to be unstable. Chairs are not designed to be placed seat down on table surfaces. Chairs stored in this manner are unstable. The shock of chairs falling from table tops may compromise the structural integrity of the shell/base attachment.

## Warranty

---

All merchandise is manufactured in accordance with our high industrial and design standards and is warranted to be free from defects of material and workmanship for a period of (5) five years from the date of delivery or placement in storage. This warranty covers goods under normal use and is in service under conditions for which the merchandise is designed. Leland International considers normal use to be (5) five days per week (8) eight hours per day. Extended use (multiple shifts, 24 hour facilities, etc) will reduce this warranty to (2) two years. We offer no warranty on chair upholstery materials, plastic laminate table surfaces and operating components other than those expressed by the manufacturer of those components.

Our obligation during this warranty period is limited to repair or replacement at our option. This warranty becomes null and void on any goods repaired or altered by any person not so authorized by Leland International or any merchandise which has been subject to misuse, improper storage, including placing chairs seat down on tables, negligence, or accident. We make no other warranties either expressed or implied as to any matter whatsoever, including without limitation, the condition of the merchandise, its merchantability, or its fitness for any particular user or purpose.

All claims will be processed by the Customer Experience Department. All returns must be authorized in writing. Merchandise authorized for return and subsequent repair or replacement merchandise shall be removed from service. All shipping, packaging, and installation charges shall be at the expense of the customer. Since furniture is installed and used under a variety of conditions, users are required to make inspections every six months to look for damage or

signs of structural fatigue incurred in daily handling, use, or abuse. Inspections must include, but are not limited to, the tightening of bolts and fasteners, and the lubrication of mechanisms. Failure to properly maintain Leland products will void this warranty.

Leland International will not be liable for loss of time, inconvenience, commercial loss, or incidental or consequential damages that may result from a warranty claim.

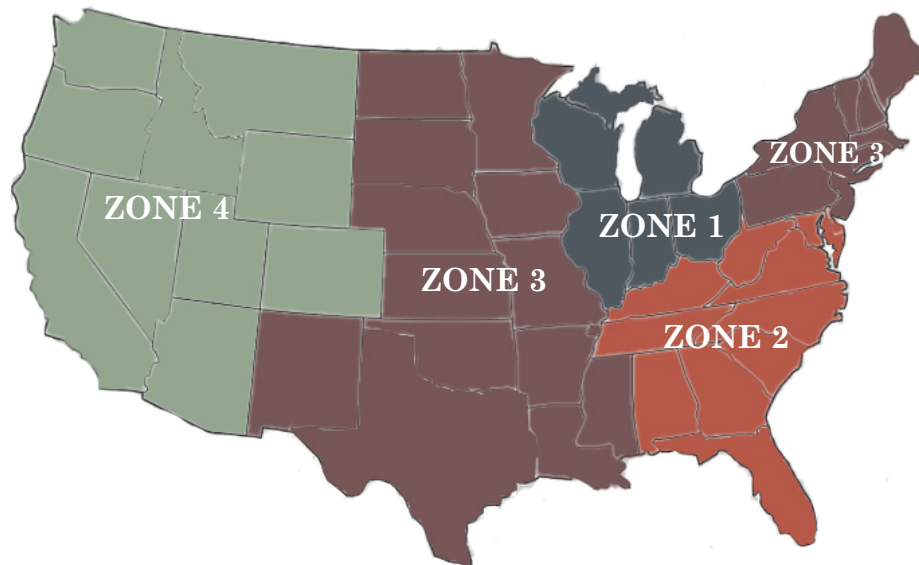

Zone 1 (4%)	Zone 2 (5%)	Zone 3 (6%)	Zone 3 (6%) CONT.	Zone 4 (7%)
Indiana	Alabama	Arkansas	New Hampshire	Arizona
Illinois	Delaware	Connecticut	New Jersey	California
Michigan	Florida	Iowa	New Mexico	Colorado
Ohio	Georgia	Kansas	New York	Idaho
Wisconsin	Kentucky	Louisiana	North Dakota	Montana
	Maryland	Maine	Oklahoma	Nevada
	North Carolina	Massachusetts	Pennsylvania	Oregon
	South Carolina	Minnesota	Rhode Island	Utah
	Tennessee	Mississippi	South Dakota	Washington
	Virginia	Missouri	Texas	Wyoming
	Washington DC	Nebraska	Vermont	
	West Virginia			

**Overview**

Leland Furniture's Freight Program is offered to all customers for convenient and competitive freight prices in the continental United States.

**How It Works**

1. Determine the LIST value of your order.
2. Determine the zone to which the freight will be shipping (Zones 1-4)
3. Calculate your freight charges by multiplying the list price and applicable zone charges (e.g.: \$10,000 LIST order shipping to Arizona is \$10,000 x 0.07 = \$700 NET freight).
4. Verify that your calculated charges meet or exceed minimums.
5. Note on your PO "Freight determined by Leland Freight Program".

**Zone Percentages and Minimums**

Zone 1	4%	Minimum \$350
Zone 2	5%	Minimum \$350
Zone 3	6%	Minimum \$350
Zone 4	7%	Minimum \$350

**Remember**

Freight percentages are based on LIST price of order.

Leland Furniture Freight Program is based on dockside delivery only. Residential Delivery, Inside Delivery, etc. will incur additional charges; please contact Leland Customer Service for current prices.

Freight is FOB Grand Rapids, MI 49512; the receiving company is responsible for noting any damage at the time of delivery on the Delivery Receipt. Leland Furniture assumes no responsibility for freight damage, either noted on delivery receipt or concealed.

As fuel prices fluctuate, Leland Furniture reserves the right to add necessary fuel surcharges.

Leland Furniture reserves the right to change or discontinue the Freight Program at any time.



# Amadeus

## January 2023 Price List





# Amadeus

Table of Contents	AM2
Specification Information	AM3
Specification Example	AM4
Stacking/ganging sled base	AM5
Stacking Chair Tapered Four Leg Base	AM7
Arm Chair, Tapered Four Leg Base	AM9
Side Chair, Wood Base	AM11
Counter Chair, Sled base	AM13
Counter Chair, Wood Base	AM15
Bar Chair, Sled base	AM17
Bar Chair, Wood Base	AM19

**Chair Model**

DESCRIPTION	CODE
AMADEUS stacking/ganging sled base	AMS
AMADEUS stacking chair, tapered four leg base	AM4
AMADEUS arm chair, tapered four leg base	AMA
AMADEUS side chair, wood base	AMSW
AMADEUS counter chair	AMCS
AMADEUS counter chair, wood base	AMCW
AMADEUS bar chair	AMBS
AMADEUS bar chair, wood base	AMBW

**Shell Selection**

DESCRIPTION	CODE
Polypropylene	PO
Polypropylene with Upholstered Seat Onlay	PU
Fully Upholstered	FU
3D Beech Veneer	3DB
3D Beech Veneer with Upholstered Seat Onlay	3BU
3D American Walnut Veneer	3DW
3D American Walnut Veneer with Upholstered Seat Onlay	3WU

**Shell Finish/Color**

**POLYPROPYLENE SHELL:**

DESCRIPTION	CODE	DESCRIPTION	CODE
White	WT	Oxford	OX
Black	BK	Dolphin	DL
Fawn	FW	Seafoam	SF
Fog	FG	Habanero	HB
Blue Sky	BS	Dijon	DJ
Ink	IN		

**CUSTOM POLYPROPYLENE COLORS**

Custom color match is available upon request.  
Please contact [hello@lelandfurniture.com](mailto:hello@lelandfurniture.com) for further information

**BEECH 3D VENEER SHELL:**

DESCRIPTION	CODE
Natural Beech	09

**STANDARD LELAND COLORS**

**AMERICAN WALNUT 3D VENEER SHELL:**

DESCRIPTION	CODE
Natural Walnut Matte	08M

**Fully Upholstered or Onlay Selection**

Please refer to Leland Textile Program which features textiles and leathers from the following partners:

- Camira
- Carnegie
- CF Stinson
- Green Hides
- Maharam
- Unika Vaev

The complete grade list can be found on our website or you can specify COM/COL. Due to the design of this product, it is recommended that all non pre-approved textile be tested for compatibility.

**Frame Finishes**

**SLED BASE & TAPERED FOUR LEG BASE:**

DESCRIPTION	CODE
Sterling	ST
Warm Grey	WG
Cool Grey	CG
Black	B
White	W
Habanero	HBN
Matte Seafoam	MSF
Matte Dijon	MDJ
Matte Mercury	MMR
Matte Mineral	MMN
Matte Burnish	MBN
Matte Foundry	MFN
Chrome	C

**TEXTURED**

DESCRIPTION	CODE
White Textured Powder coat	WT
Black Textured Powder coat	BT
Grey Textured Powder coat	GT
Ink Textured Powder Coat	INT

**Glide or Caster Type**

**STANDARD GLIDES:**

DESCRIPTION	CODE
Poly (Sled base)	S
Nylon (Tapered Four leg Base) & Wood Base	S

**OPTIONAL GLIDES:**

DESCRIPTION	CODE
Felt	FC

\*Please note that optional glides for four leg models raise the chair height .5 inch.

**Stacking note**

Amadeus side chair, armless models stack as follows: (including upholstered)

**SLED BASE:**

**ARMLESS:**  
Floor: 15 High  
Dolly: 20 High

**TAPERED FOUR LEG BASE:**

**ARMLESS:**  
Floor: 10 High  
Dolly: 12 High

**Specifications required to create the product code**

- Model
- Shell Selection
- Shell Finish/Color
- Upholstered Onlay Selection (when applicable)
- Frame Finish (or foot ring where applicable)
- Glide Type

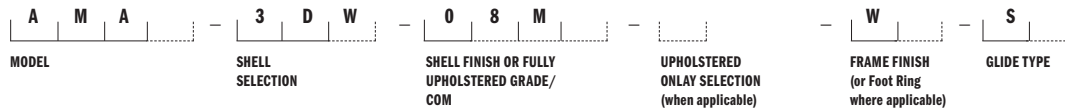

**MODEL**

Amadeus arm chair, Tapered four leg base (AMA)

**SHELL SELECTION**

3D American Walnut Veneer (3DW)

**SHELL FINISH/COLOR**

Natural Walnut Matte (08M)

**UPHOLSTERED ONLAY SELECTION**

When applicable, enter upholstery grade, COM

**FRAME FINISH (OR FOOT RING WHERE APPLICABLE)**

White (W)

**GLIDE TYPE**

Standard Nylon (S)



AMADEUS STACKING/GANGING SLED BASE  
Design: Martin Ballendat

AM5



Amadeus Sled Base Chair	MODEL	FRAME FINISH	LIST PRICE
Polypropylene shell	AMS-PO	Powder Coat	\$400
W 21 D 21.75 H 31.75 SH 18		Chrome	\$463

Optional Glides: Add \$8.00 net per chair for a set of four (4).



Amadeus Sled Base Chair	MODEL	LIST PRICE/GRADE	COM/COL	A	B	C	D	E	F	G	H	I	J	K	L
Polypropylene shell upholstered seat onlay	AMS-PU	Powder Coat	\$538	582	603	625	647	668	691	712	734	755	778	799	821
		Chrome	\$600	644	665	687	709	731	752	774	796	817	840	861	883

W 21 D 21.75 H 32 SH 19

COM Yardage: 1 or 2 seats: .75 yard  
Contact Leland Customer Experience for yardage requirements on textiles with repeats.  
Optional Glides: Add \$8.00 net per chair for a set of four (4).



Amadeus Sled Base Chair	MODEL	LIST PRICE/GRADE	COM/COL	A	B	C	D	E	F	G	H	I	J	K	L
Fully upholstered	AMS-FU	Powder Coat	\$725	821	870	920	968	1019	1068	1117	1166	1216	1265	1315	1364
		Chrome	\$793	891	940	989	1038	1088	1138	1187	1236	1285	1336	1385	1433

W 21 D 21.75 H 32 SH 18

COM Yardage: 1 seat: 1.5 yards  
Contact Leland Customer Experience for yardage requirements on textiles with repeats.  
Optional Glides: Add \$8.00 net per chair for a set of four (4).

To specify:  
Please refer to pages 3-4 for complete specifying information.  
Specify all products by their product code.

Pricing Effective: January 2023

AMADEUS STACKING/GANGING SLED BASE  
Design: Martin Ballendat

AM6



Amadeus Sled Base Chair	MODEL	FRAME FINISH	LIST PRICE
3D Beech veneer shell	AMS-3DB	Powder Coat	\$771
W 21 D 21.75 H 31.75 SH 18		Chrome	\$839

Optional Glides: Add \$8.00 net per chair for a set of four (4).



Amadeus Sled Base Chair	MODEL	LIST PRICE/GRADE	COM/COL	A	B	C	D	E	F	G	H	I	J	K	L
3D Beech veneer shell, upholstered seat onlay	AMS-3BU	Powder Coat	\$918	965	988	1012	1035	1058	1083	1107	1129	1154	1176	1199	1223
		Chrome	\$985	1033	1056	1079	1103	1127	1149	1174	1197	1220	1244	1267	1290

W 21 D 21.75 H 32 SH 19

COM Yardage: 1 or 2 seats: .75 yard  
Contact Leland Customer Experience for yardage requirements on textiles with repeats.  
Optional Glides: Add \$8.00 net per chair for a set of four (4).



Amadeus Sled Base Chair	MODEL	FRAME FINISH	LIST PRICE
3D Walnut veneer shell	AMS-3DW	Powder Coat	\$1114
W 21 D 21.75 H 31.75 SH 18		Chrome	\$1180

Optional Glides: Add \$8.00 net per chair for a set of four (4).



Amadeus Sled Base Chair	MODEL	LIST PRICE/GRADE	COM/COL	A	B	C	D	E	F	G	H	I	J	K	L
3D Walnut veneer shell, upholstered seat onlay	AMS-3WU	Powder Coat	\$1262	1308	1334	1356	1380	1403	1427	1449	1474	1496	1520	1544	1567
		Chrome	\$1328	1374	1399	1423	1446	1469	1493	1516	1539	1563	1587	1610	1635

W 21 D 21.75 H 32 SH 19

COM Yardage: 1 or 2 seats: .75 yard  
Contact Leland Customer Experience for yardage requirements on textiles with repeats.  
Optional Glides: Add \$8.00 net per chair for a set of four (4).

To specify:  
Please refer to pages 3-4 for complete specifying information.  
Specify all products by their product code.

Pricing Effective: January 2023



**Amadeus  
Tapered Four Leg Base Chair**

	MODEL	FRAME FINISH	LIST PRICE
Polypropylene shell	AM4-PO	Powder Coat	\$461
W 21 D 22 H 32 SH 18		Chrome	\$525

Optional Glides: Add \$8.00 net per chair for a set of four (4).



**Amadeus  
Tapered Four Leg Base Chair**

	MODEL	LIST PRICE/GRADE	COM/COL	A	B	C	D	E	F	G	H	I	J	K	L
Polypropylene shell, upholstered seat onlay	AM4-PU	Powder Coat	\$599	643	664	686	708	729	751	773	795	816	838	860	882
		Chrome	\$662	705	727	749	770	793	814	836	858	880	901	924	945

W 21.5 D 22 H 32 SH 19

COM Yardage: 1 or 2 seats: .75 yard  
Contact Leland Customer Experience for yardage requirements on textiles with repeats.  
Optional Glides: Add \$8.00 net per chair for a set of four (4).



**Amadeus  
Tapered Four Leg Base Chair**

	MODEL	LIST PRICE/GRADE	COM/COL	A	B	C	D	E	F	G	H	I	J	K	L
Fully upholstered	AM4-FU	Powder Coat	\$792	889	939	988	1037	1087	1137	1185	1235	1284	1335	1383	1432
		Chrome	\$862	962	1011	1059	1110	1158	1208	1256	1306	1356	1405	1453	1503

W 21.5 D 22 H 32 SH 18

COM Yardage: 1 seat: 1.5 yards  
Contact Leland Customer Experience for yardage requirements on textiles with repeats.  
Optional Glides: Add \$8.00 net per chair for a set of four (4).

To specify:  
Please refer to pages 3-4 for complete specifying information.  
Specify all products by their product code.





**Amadeus  
Tapered Four Leg Base Chair**

	MODEL	FRAME FINISH	LIST PRICE
3D Beech veneer shell	AM4-3DB	Powder Coat	\$838
W 21.5 D 22 H 32 SH 18		Chrome	\$904

Optional Glides: Add \$8.00 net per chair for a set of four (4).



**Amadeus  
Tapered Four Leg Base Chair**

	MODEL	LIST PRICE/GRADE	COM/COL	A	B	C	D	E	F	G	H	I	J	K	L
3D Beech veneer shell, upholstered seat onlay	AM4-3BU	Powder Coat	\$984	1032	1054	1078	1101	1126	1148	1173	1195	1219	1243	1266	1289
		Chrome	\$1051	1097	1122	1145	1169	1192	1215	1238	1262	1285	1308	1334	1356

W 21.5 D 22 H 32 SH 19

COM Yardage: 1 or 2 seats: .75 yard  
Contact Leland Customer Experience for yardage requirements on textiles with repeats.  
Optional Glides: Add \$8.00 net per chair for a set of four (4).



**Amadeus  
Tapered Four Leg Base Chair**

	MODEL	FRAME FINISH	LIST PRICE
3D Walnut veneer shell	AM4-3DW	Powder Coat	\$1180
W 21.5 D 22 H 32 SH 18		Chrome	\$1250

Optional Glides: Add \$8.00 net per chair for a set of four (4).



**Amadeus  
Tapered Four Leg Base Chair**

	MODEL	LIST PRICE/ GRADE	COM/COL	A	B	C	D	E	F	G	H	I	J	K	L
3D Walnut veneer shell upholstered seat onlay	AM4-3WU	Powder Coat	\$1328	1374	1399	1423	1446	1469	1493	1516	1539	1563	1587	1610	1635
		Chrome	\$1397	1444	1466	1490	1514	1537	1560	1584	1608	1630	1655	1677	1701

W 21.5 D 22 H 32 SH 19

COM Yardage: 1 or 2 seats: .75 yard  
Contact Leland Customer Experience for yardage requirements on textiles with repeats.  
Optional Glides: Add \$8.00 net per chair for a set of four (4).

**To specify:  
Please refer to pages 3-4 for  
complete specifying information.  
Specify all products by their  
product code.**

AMADEUS ARM CHAIR, TAPERED FOUR LEG BASE  
Design: Martin Ballendat

AM9



**Amadeus Arm Chair  
Tapered Four Leg Base Chair**

	MODEL	FRAME FINISH	LIST PRICE
Polypropylene shell	AMA-PO	Powder Coat	\$574
W 23.5 D 21.75 H 32 SH 18 AH 26		Chrome	\$683

Optional Glides: Add \$8.00 net per chair for a set of four (4).



**Amadeus Arm Chair  
Tapered Four Leg Base Chair**

	MODEL	LIST PRICE/GRADE	COM/COL	A	B	C	D	E	F	G	H	I	J	K	L
Polypropylene shell, upholstered seat onlay	AMA-PU	Powder Coat	\$732	782	807	834	859	883	909	933	958	984	1008	1033	1057
		Chrome	\$820	870	896	920	947	971	996	1021	1047	1071	1096	1121	1146

W 23.75 D 22 H 32  
SH 19 AH 26

COM Yardage: 1 or 2 seats: .75 yard  
Contact Leland Customer Experience for yardage requirements on textiles with repeats.  
Optional Glides: Add \$8.00 net per chair for a set of four (4).



**Amadeus  
Tapered Four Leg Base Chair**

	MODEL	LIST PRICE/GRADE	COM/COL	A	B	C	D	E	F	G	H	I	J	K	L
Fully upholstered	AMA-FU	Powder Coat	\$952	1064	1120	1177	1234	1288	1345	1402	1458	1514	1568	1624	1681
		Chrome	\$1050	1161	1218	1275	1330	1387	1443	1499	1555	1612	1668	1725	1779

W 23.5 D 21.75 H 32  
SH 18 H 26

COM Yardage: 1 seat: 1.5 yards  
Contact Leland Customer Experience for yardage requirements on textiles with repeats.  
Optional Glides: Add \$8.00 net per chair for a set of four (4).

To specify:  
Please refer to pages 3-4 for complete specifying information.  
Specify all products by their product code.

Pricing Effective: January 2023

AMADEUS ARM CHAIR, TAPERED FOUR LEG BASE  
Design: Martin Ballendat

AM10



**Amadeus Arm Chair  
Tapered Four Leg Base**

	MODEL	FRAME FINISH	LIST PRICE
3D Beech veneer shell	AMA-3DB	Powder Coat	\$1041
W 23.75 D 22 H 32 SH 19 AH 26		Chrome	\$1156

Optional Glides: Add \$8.00 net per chair for a set of four (4).



**Amadeus Arm Chair  
Tapered Four Leg Base Chair**

	MODEL	LIST PRICE/ GRADE	COM/COL	A	B	C	D	E	F	G	H	I	J	K	L
3D Beech veneer shell, upholstered seat onlay	AMA-3BU	Powder Coat	\$1208	1262	1287	1316	1342	1368	1395	1422	1448	1474	1503	1528	1555
		Chrome	\$1288	1343	1370	1397	1424	1450	1478	1504	1530	1557	1583	1611	1636

W 23.75 D 22 H 32  
SH 19 AH 26

COM Yardage: 1 or 2 seats: .75 yard  
Contact Leland Customer Experience for yardage requirements on textiles with repeats.  
Optional Glides: Add \$8.00 net per chair for a set of four (4).



**Amadeus Arm Chair  
Tapered Four Leg Base**

	MODEL	FRAME FINISH	LIST PRICE
3D Walnut veneer shell	AMA-3DW	Powder Coat	\$1471
W 23.5 D 21.75 H 32 SH 18 AH 26		Chrome	\$1588

Optional Glides: Add \$8.00 net per chair for a set of four (4).



**Amadeus Arm Chair  
Tapered Four Leg Base**

	MODEL	LIST PRICE/ GRADE	COM/COL	A	B	C	D	E	F	G	H	I	J	K	L
3D Walnut veneer shell, upholstered seat onlay	AMA-3WU	Powder Coat	\$1640	1693	1721	1747	1773	1800	1828	1853	1881	1908	1934	1960	1989
		Chrome	\$1751	1806	1831	1857	1886	1911	1938	1966	1993	2018	2046	2072	2099

W 23.5 D 22 H 32  
SH 19 H 26

COM Yardage: 1 or 2 seats: .75 yard  
Contact Leland Customer Experience for yardage requirements on textiles with repeats.  
Optional Glides: Add \$8.00 net per chair for a set of four (4).

**To specify:**  
Please refer to pages 3-4 for complete specifying information.  
Specify all products by their product code.

AMADEUS SIDE CHAIR, POLY SHELL, WOOD BASE  
 Design: Martin Ballendat

AM11

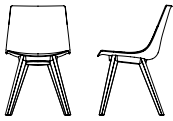

**Amadeus Side Chair**

Wood Base	MODEL	FRAME FINISH	LIST PRICE
Polypropylene shell	AMSW-PO		\$841
W 19 D 22 H 32 SH 18		Optional Glides: Add \$8.00 net per chair for a set of four (4).	

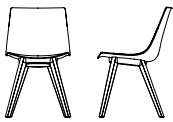

**Amadeus Side Chair**

Wood Base	MODEL	LIST PRICE/GRADE	COM/COL	A	B	C	D	E	F	G	H	I	J	K	L
Polypropylene shell, upholstered seat onlay	AMSW-PU		\$978	1021	1044	1065	1087	1109	1130	1152	1174	1196	1217	1240	1261
W 19 D 22 H 32 SH 19		COM Yardage: 1 or 2 seats: .75 yard Contact Leland Customer Experience for yardage requirements on textiles with repeats. Optional Glides: Add \$8.00 net per chair for a set of four (4)													

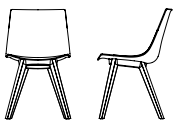

**Amadeus Side Chair**

Wood Base	MODEL	LIST PRICE/ GRADE	COM/COL	A	B	C	D	E	F	G	H	I	J	K	L
Fully upholstered	AMSW-FU		\$1220	1319	1368	1416	1466	1516	1566	1614	1664	1713	1761	1810	1861
W 19 D 22 H 32.5 SH 18		COM Yardage: 1 seat: 1.5 yards Contact Leland Customer Experience for yardage requirements on textiles with repeats. Optional Glides: Add \$8.00 net per chair for a set of four (4)													

To specify:  
 Please refer to pages 3-4 for complete specifying information.  
 Specify all products by their product code.

Pricing Effective: January 2023

AMADEUS SIDE CHAIR, WOOD BASE  
Design: Martin Ballendat

AM12

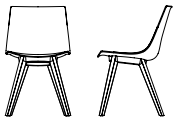

**Amadeus Side Chair  
Wood Base**

	MODEL	FRAME FINISH	LIST PRICE
3D beech veneer shell	AMSW-3DB		\$1683
W 19 D 22 H 32 SH 18		Optional Glides: Add \$8.00 net per chair for a set of four (4).	

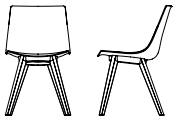

**Amadeus Side Chair  
Wood Base**

	MODEL	LIST PRICE/ GRADE	COM/ COL	A	B	C	D	E	F	G	H	I	J	K	L
3D beech veneer shell, upholstered seat onlay	AMSW-3BU		\$1831	1877	1899	1925	1947	1971	1995	2018	2041	2065	2088	2112	2136
W 19 D 22 H 32 SH 18			COM Yardage: 1 or 2 seats: .75 yard Contact Leland Customer Experience for yardage requirements on textiles with repeats. Optional Glides: Add \$8.00 net per chair for a set of four (4)												

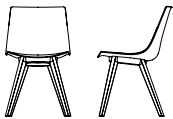

**Amadeus Side Chair  
Wood Base**

	MODEL	FRAME FINISH	LIST PRICE
3D american walnut veneer shell	AMSW-3DW		\$2028
W 19 D 22 H 32 SH 18		Optional Glides: Add \$8.00 net per chair for a set of four (4).	

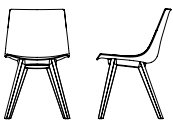

**Amadeus Side Chair  
Wood Base**

	MODEL	LIST PRICE/ GRADE	COM/ COL	A	B	C	D	E	F	G	H	I	J	K	L
3D american walnut veneer shell, upholstered seat onlay	AMSW-3WU		\$2174	2221	2245	2268	2291	2315	2338	2361	2387	2409	2433	2456	2480
W 19 D 22 H 32 SH 18			COM Yardage: 1 or 2 seats: .75 yard Contact Leland Customer Experience for yardage requirements on textiles with repeats. Optional Glides: Add \$8.00 net per chair for a set of four (4)												

To specify:  
Please refer to pages 3-4 for  
complete specifying information.  
Specify all products by their  
product code.

Pricing Effective: January 2023

AMADEUS COUNTER CHAIR, SLED BASE  
Design: Martin Ballendat

AM13

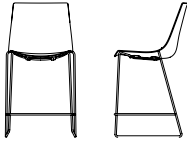

**Amadeus Counter Chair,  
Sled Base**

	MODEL	FRAME FINISH	LIST PRICE
Polypropylene shell	AMCS-PO	Powder Coat	\$633
W 20.5 D 21.5 H 38.5 SH 26		Chrome	\$709

Optional Glides: Add \$8.00 net per chair for a set of four (4).

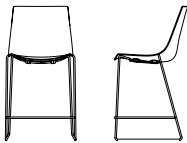

**Amadeus Counter Chair,  
Sled Base**

	MODEL	LIST PRICE/GRADE	COM/COL	A	B	C	D	E	F	G	H	I	J	K	L
Polypropylene shell, upholstered seat onlay	AMCS-PU	Powder Coat	\$770	814	836	858	880	901	924	945	966	989	1010	1032	1053
		Chrome	\$845	889	911	932	956	977	999	1020	1043	1064	1085	1108	1129

W 20.5 D 21.5 H 38.5 SH 26

COM Yardage: 1 or 2 seats: .75 yard  
Contact Leland Customer Experience for yardage requirements on textiles with repeats.  
For COL requirements please contact Leland Customer Experience.  
Optional Glides: Add \$8.00 net per chair for a set of four (4).

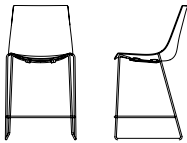

**Amadeus Counter Chair,  
Sled Base**

	MODEL	LIST PRICE/GRADE	COM/ COL	A	B	C	D	E	F	G	H	I	J	K	L
Fully upholstered	AMCS-FU	Powder Coat	\$985	1085	1134	1183	1233	1282	1332	1381	1430	1478	1527	1576	1625
		Chrome	\$1070	1169	1218	1267	1318	1367	1415	1465	1515	1565	1613	1661	1712

W 20.5 D 21.5 H 38.5 SH 26

COM Yardage: 1 seat: 1.5 yards  
Contact Leland Customer Experience for yardage requirements on textiles with repeats.  
For COL requirements please contact Leland Customer Experience.  
Optional Glides: Add \$8.00 net per chair for a set of four (4).

To specify:  
Please refer to pages 3-4 for complete specifying information.  
Specify all products by their product code.

Pricing Effective: January 2023



AMADEUS COUNTER CHAIR, SLED BASE  
Design: Martin Ballendat

AM14

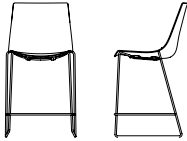

**Amadeus Counter Chair,  
Sled Base**

	MODEL	FRAME FINISH	LIST PRICE
3D Beech veneer shell	AMCS-3DB	Powder Coat	\$1330
W 21 D 21.5 H 38.5 SH 26		Chrome	\$1411

Optional Glides: Add \$8.00 net per chair for a set of four (4).

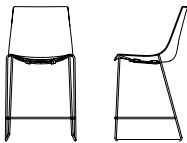

**Amadeus Counter Chair,  
Sled Base**

	MODEL	LIST PRICE/ GRADE	COM/COL	A	B	C	D	E	F	G	H	I	J	K	L
3D Beech veneer shell, upholstered seat onlay	AMCS-3BU	Powder Coat	\$1477	1524	1548	1571	1594	1619	1641	1665	1688	1713	1735	1758	1782
		Chrome	\$1558	1605	1628	1653	1675	1699	1721	1746	1769	1792	1817	1839	1863

W 20.5 D 21.5 H 38.5 SH 26

COM Yardage: 1 or 2 seats: .75 yard  
Contact Leland Customer Experience for yardage requirements on textiles with repeats.  
Optional Glides: Add \$8.00 net per chair for a set of four (4).

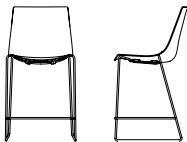

**Amadeus Counter Chair,  
Sled Base**

	MODEL	FRAME FINISH	LIST PRICE
3D Walnut veneer shell	AMCS-3DW	Powder Coat	\$1509
W 20.5 D 21.5 H 38.5 SH 26		Chrome	\$1589

Optional Glides: Add \$8.00 net per chair for a set of four (4)..

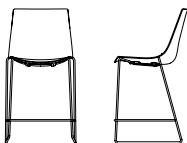

**Amadeus Sled Base Chair**

	MODEL	LIST PRICE/GRADE	COM/ COL	A	B	C	D	E	F	G	H	I	J	K	L
3D Walnut veneer shell, upholstered seat onlay	AMCS-3WU	Powder Coat	\$1656	1702	1726	1749	1772	1797	1820	1843	1867	1891	1913	1938	1960
		Chrome	\$1735	1782	1805	1829	1852	1876	1898	1924	1946	1970	1993	2017	2040

W 20.5 D 21.5 H 38.5 SH 26

COM Yardage: 1 or 2 seats: .75 yard  
Contact Leland Customer Experience for yardage requirements on textiles with repeats.  
Optional Glides: Add \$8.00 net per chair for a set of four (4).

To specify:

Please refer to pages 3-4 for complete specifying information.  
Specify all products by their product code.

Pricing Effective: January 2023

AMADEUS COUNTER CHAIR, WOOD BASE  
Design: Martin Ballendat

AM15

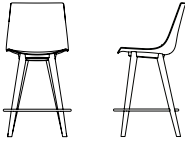

**Amadeus Counter Chair**

**Wood Base**

	MODEL	FRAME FINISH	LIST PRICE
Polypropylene shell	AMCW-PO		\$1216
W 20 D 22.5 H 40 SH 25.5		Optional Glides: Add \$8.00 net per chair for a set of four (4).	

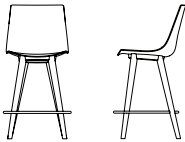

**Amadeus Counter Chair**

**Wood Base**

	MODEL	LIST PRICE/ GRADE	COM/ COL	A	B	C	D	E	F	G	H	I	J	K	L
Polypropylene shell, upholstered seat onlay	AMCW-PU		\$1352	1397	1419	1441	1463	1484	1507	1528	1550	1572	1594	1615	1638
W 20 D 22.5 H 40 SH 25.5			COM Yardage: 1 or 2 seats: .75 yard Contact Leland Customer Experience for yardage requirements on textiles with repeats. Optional Glides: Add \$8.00 net per chair for a set of four (4)												

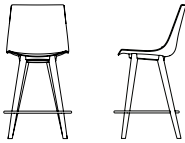

**Amadeus Counter Chair**

**Wood Base**

	MODEL	LIST PRICE/ GRADE	COM/ COL	A	B	C	D	E	F	G	H	I	J	K	L
Fully upholstered	AMCW-FU		\$1643	1743	1791	1841	1891	1940	1989	2038	2088	2137	2185	2235	2285
W 20 D 22.5 H 40 SH 25.5			COM Yardage: 1 seat: 1.5 yards Contact Leland Customer Experience for yardage requirements on textiles with repeats. Optional Glides: Add \$8.00 net per chair for a set of four (4).												

To specify:  
Please refer to pages 3-4 for complete specifying information.  
Specify all products by their product code.

Pricing Effective: January 2023

AMADEUS COUNTER CHAIR, WOOD BASE  
Design: Martin Ballendat

AM16

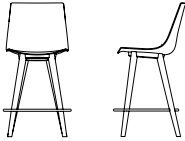

**Amadeus Counter Chair**

**Wood Base**

	MODEL	FRAME FINISH	LIST PRICE
3D Beech veneer shell	AMCW-3DB		\$2087
W 20 D 22.5 H 40 SH 25.5		Optional Glides: Add \$8.00 net per chair for a set of four (4).	

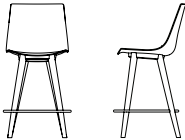

**Amadeus Counter Chair**

**Wood Base**

	MODEL	LIST PRICE/ GRADE	COM/ COL	A	B	C	D	E	F	G	H	I	J	K	L
3D Beech veneer shell, upholstered seat onlay	AMCW-3BU		\$2233	2282	2305	2328	2352	2375	2397	2422	2444	2469	2493	2516	2539
W 20 D 22.5 H 40 SH 26			COM Yardage: 1 or 2 seats: .75 yard Contact Leland Customer Experience for yardage requirements on textiles with repeats. Optional Glides: Add \$8.00 net per chair for a set of four (4)												

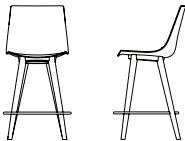

**Amadeus Counter Chair**

**Wood Base**

	MODEL	FRAME FINISH	LIST PRICE
3D American walnut veneer shell	AMCW-3DW		\$2372
W 20 D 22.5 H 40 SH 25.5		Optional Glides: Add \$8.00 net per chair for a set of four (4).	

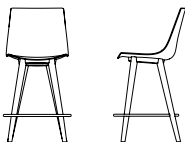

**Amadeus Counter Chair**

**Wood Base**

	MODEL	LIST PRICE/ GRADE	COM/ COL	A	B	C	D	E	F	G	H	I	J	K	L
3D American walnut veneer shell, upholstered seat onlay	AMCW-3WU		\$2518	2565	2588	2612	2636	2660	2682	2707	2729	2753	2777	2800	2823
W 20 D 22.5 H 40 SH 26			COM Yardage: 1 or 2 seats: .75 yard Contact Leland Customer Experience for yardage requirements on textiles with repeats. Optional Glides: Add \$8.00 net per chair for a set of four (4)												

To specify:

Please refer to pages 3-4 for complete specifying information. Specify all products by their product code.

Pricing Effective: January 2023

AMADEUS BAR CHAIR, SLED BASE  
Design: Martin Ballendat

AM17

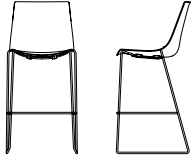

**Amadeus Bar Chair  
Sled Base**

	MODEL	FRAME FINISH	LIST PRICE
Polypropylene shell	AMBS-PO	Powder Coat	\$719
W 20.5 D 21.5 H 43.75 SH 29		Chrome	\$784

Optional Glides: Add \$8.00 net per chair for a set of four (4).

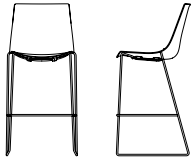

**Amadeus Bar Chair  
Sled Base**

	MODEL	LIST PRICE/GRADE	COM/COL	A	B	C	D	E	F	G	H	I	J	K	L
Polypropylene shell upholstered seat onlay	AMBS-PU	Powder Coat	\$857	900	921	944	965	987	1009	1031	1052	1075	1096	1118	1140
		Chrome	\$921	965	987	1009		1052	1075	1096	1118	1140	1162	1183	1206

W 21 D 21.5 H 44 SH 30

COM Yardage: 1 or 2 seats: .75 yard  
Contact Leland Customer Experience for yardage requirements on textiles with repeats.  
For COL requirements please contact Leland Customer Experience.  
Optional Glides: Add \$8.00 net per chair for a set of four (4).

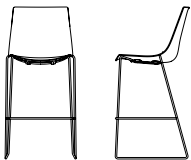

**Amadeus Bar Chair  
Sled Base**

	MODEL	LIST PRICE/ GRADE	COM/COL	A	B	C	D	E	F	G	H	I	J	K	L
Fully upholstered	AMBS-FU	Powder Coat	\$1084	1182	1232	1281	1330	1380	1428	1476	1525	1575	1624	1674	1724
		Chrome	\$1157	1255	1305	1355	1403	1451	1502	1551	1600	1650	1699	1748	1798

W 20.5 D 21.5 H 43.75  
SH 29

COM Yardage: 1 seat: 1.5 yards  
Contact Leland Customer Experience for yardage requirements on textiles with repeats.  
For COL requirements please contact Leland Customer Experience.  
Optional Glides: Add \$8.00 net per chair for a set of four (4).

To specify:  
Please refer to pages 3-4 for complete specifying information.  
Specify all products by their product code.

Pricing Effective: January 2023

AMADEUS BAR CHAIR, SLED BASE  
Design: Martin Ballendat

AM18

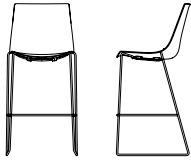

**Amadeus Bar Chair  
Sled Base**

	MODEL	FRAME FINISH	LIST PRICE
3D Beech veneer shell	AMBS-3DB	Powder Coat	\$1423
W 20.5 D21.5 H 43.75 SH 29		Chrome	\$1492

Optional Glides: Add \$8.00 net per chair for a set of four (4).

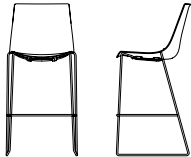

**Amadeus Bar Chair  
Sled Base**

	MODEL	LIST PRICE/ GRADE	COM/COL	A	B	C	D	E	F	G	H	I	J	K	L
3D Beech veneer shell, upholstered onlay	AMBS-3BU	Powder Coat	\$1570	1617	1640	1662	1687	1710	1734	1757	1781	1804	1827	1851	1875
		Chrome	\$1639	1685	1709	1733	1756	1780	1803	1826	1850	1874	1896	1922	1944

W 21 D 21.5 H 44 SH 30

COM Yardage: 1 or 2 seats: .75 yard  
Contact Leland Customer Experience for yardage requirements on textiles with repeats.  
For COL requirements please contact Leland Customer Experience.  
Optional Glides: Add \$8.00 net per chair for a set of four (4).

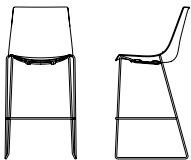

**Amadeus Bar Chair  
Sled Base**

	MODEL	FRAME FINISH	LIST PRICE
3D Walnut veneer shell	AMBS-3DW	Powder Coat	\$1601
W 21 D21.5 H 44 SH 29.5		Chrome	\$1671

Optional Glides: Add \$8.00 net per chair for a set of four (4).

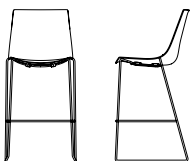

**Amadeus Bar Chair  
Sled Base**

	MODEL	LIST PRICE/ GRADE	COM/ COL	A	B	C	D	E	F	G	H	I	J	K	L
3D Walnut veneer shell upholstered seat onlay	AMBS-3WU	Powder Coat	\$1748	1796	1819	1842	1865	1890	1912	1936	1959	1982	2006	2030	2053
		Chrome	\$1818	1864	1888	1911	1933	1958	1981	2004	2029	2052	2075	2100	2122

W 21 D 21.5 H 44 SH 30

COM Yardage: 1 or 2 seats: .75 yard  
Contact Leland Customer Experience for yardage requirements on textiles with repeats.  
For COL requirements please contact Leland Customer Experience.  
Optional Glides: Add \$8.00 net per chair for a set of four (4).

**To specify:  
Please refer to pages 3-4 for  
complete specifying information.  
Specify all products by their  
product code.**

AMADEUS BAR CHAIR, WOOD BASE  
Design: Martin Ballendat

AM19

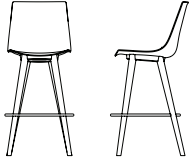

**Amadeus Bar Chair**

**Wood Base**

	MODEL	FRAME FINISH	LIST PRICE
Polypropylene shell	AMBW-PO		\$1409
W 20 D22.5 H 44 SH 29		Optional Glides: Add \$8.00 net per chair for a set of four (4).	

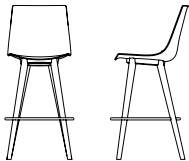

**Amadeus Bar Chair**

**Wood Base**

	MODEL	LIST PRICE/ GRADE	COM/ COL	A	B	C	D	E	F	G	H	I	J	K	L
Polypropylene shell upholstered seat onlay	AMBW-PU		\$1546	1590	1612	1633	1656	1677	1699	1721	1743	1764	1787	1808	1829
W 20 D 22.5 H 44 SH 29.5		COM Yardage: 1 or 2 seats: .75 yard Contact Leland Customer Experience for yardage requirements on textiles with repeats. Optional Glides: Add \$8.00 net per chair for a set of four (4)													

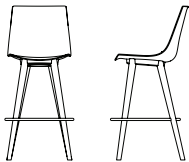

**Amadeus Bar Chair**

**Wood Base**

	MODEL	LIST PRICE/ GRADE	COM/ COL	A	B	C	D	E	F	G	H	I	J	K	L
Fully upholstered	AMBW-FU		\$1862	1959	2010	2058	2107	2157	2207	2255	2305	2354	2405	2453	2501
W 20 D 22.5 H 44 SH 29.5		COM Yardage: 1 seat: 1.5 yards Contact Leland Customer Experience for yardage requirements on textiles with repeats. Optional Glides: Add \$8.00 net per chair for a set of four (4)													

To specify:

Please refer to pages 3-4 for complete specifying information. Specify all products by their product code.

Pricing Effective: January 2023



AMADEUS BAR CHAIR, WOOD BASE  
Design: Martin Ballendat

AM20



**Amadeus Bar Chair**

**Wood Base**

	MODEL	FRAME FINISH	LIST PRICE
3D beech veneer shell	AMBW-3DB		\$2292
W 20 D 22.5 H 44 SH 29		Optional Glides: Add \$8.00 net per chair for a set of four (4).	

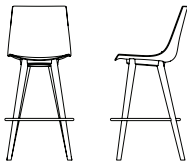

**Amadeus Bar Chair**

**Wood Base**

	MODEL	LIST PRICE/ GRADE	COM/ COL	A	B	C	D	E	F	G	H	I	J	K	L
3D beech veneer shell upholstered seat only	AMBW-3BU	\$2440		2486	2511	2534	2557	2582	2604	2628	2651	2675	2697	2722	2745
W 20 D 22.5 H 44 SH 29.5		COM Yardage: 1 or 2 seats: .75 yard Contact Leland Customer Experience for yardage requirements on textiles with repeats. Optional Glides: Add \$8.00 net per chair for a set of four (4)													



**Amadeus Bar Chair**

**Wood Base**

	MODEL	FRAME FINISH	LIST PRICE
3D american walnut veneer shell	AMBW-3DW		\$2637
W 20 D 22.5 H 44 SH 29		Optional Glides: Add \$8.00 net per chair for a set of four (4).	



**Amadeus Bar Chair**

**Wood Base**

	MODEL	LIST PRICE/ GRADE	COM/ COL	A	B	C	D	E	F	G	H	I	J	K	L
3D american walnut veneer shell, upholstered seat only	AMBW-3WU	\$2785		2832	2855	2877	2902	2924	2948	2970	2996	3019	3042	3066	3089
W 20 D 22.5 H 44 SH 29.5		COM Yardage: 1 or 2 seats: .75 yard Contact Leland Customer Experience for yardage requirements on textiles with repeats. Optional Glides: Add \$8.00 net per chair for a set of four (4)													

**To specify:**

Please refer to pages 3-4 for complete specifying information. Specify all products by their product code.

Pricing Effective: January 2023

# AMADEUS TRANSPORT/STACKING DOLLY

Design: Martin Ballendat

# AM21

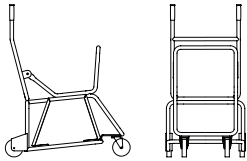

## Amadeus

### Sled Base

#### Transport/Stacking Dolly

MODEL

FRAME FINISH

LIST PRICE

Black powder coat finish

AMD-SB

\$795

W 23.5 D37.5 H 43  
(Dimensions of dolly when empty)

Sled Base: 20 high on dolly (15 high on floor)

Weight with 20 high on dolly: 470 lbs

For use with all Amadeus sled base, side chairs with poly shells, wood shells, and upholstered only

\*\*Arm, Counter, & Bar models do not stack

W 23.5 D37.5 H 70  
(Dimensions with 20 poly or wood shell chairs stacked)

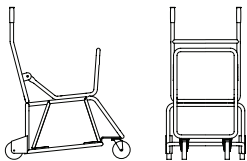

## Amadeus

### Four Leg Base

#### Transport/Stacking Dolly

MODEL

FRAME FINISH

LIST PRICE

Black powder coat finish

AMD-4L

\$1132

W 23.5 D37.5 H 43  
(Dimensions of dolly when empty)

Four Leg Base: 12 high on dolly

Weight with 12 high on dolly: 350 lbs

For use with all shell types

\*\*Arm, Counter, & Bar models do not stack

W 23.5 D37.5 H 65  
(Dimensions with 12 poly or wood shell chairs stacked )

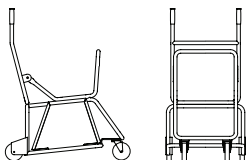

## Amadeus

### Sled Base, Fully Upholstered

#### Transport/Stacking Dolly

MODEL

FRAME FINISH

LIST PRICE

Black powder coat finish

AMD-SBFU

\$1401

W 23.5 D37.5 H 78  
(Dimensions with 20 fully upholstered chairs stacked)

Sled Base: 20 high on dolly (15 high on floor)

Weight with 20 high on dolly: 530 lbs

For use with fully upholstered shell only

\*\*Arm, Counter, & Bar models do not stack

To specify:

Please refer to pages 3-4 for complete specifying information.

Specify all products by their product code.

Pricing Effective: January 2023

---

**5695 Eagle Drive, SE  
Grand Rapids,  
Michigan 49512  
616-975-9260  
lelandfurniture.com**

# Baraga

## August 2023 Price List



# Baraga

Table of Contents	BA2
Specification Information	BA3
Specification Example	BA4
Bar Stool	BA5
Counter Stool	BA5
Low Stool	BA5

**Chair Model**

DESCRIPTION	CODE
Baraga Bar Stool	BARB
Baraga Counter Stool	BARC
Baraga Low Stool	BARS

**Seat Type**

DESCRIPTION	CODE
Oak	O
Walnut	W
Felt	F

**Wood Seat Finish**

DESCRIPTION	CODE
Natural Walnut	08M
Natural White Oak	12M
Morel	66M
Evergreen	112M
Sienna	113M
Blue Sky	114M

**Felt Seat Finish**

DESCRIPTION	CODE
Abalone	PET01
Salmon	PET02
Sandstone	PET03
Bark	PET04
Amarillo	PET05
Shamrock	PET06
Burnt Clay	PET07
Merlot	PET08
Royal	PET09
Indigo	PET10
Turmeric	PET11
Laurel	PET12
Charcoal	PET13

**Powder Coat Frame Finish**

DESCRIPTION	CODE
Black Textured	BT
White Textured	WT
Matte Mercury	MMR
Matte Burnish	MBN
Matte Foundry	MFN
Matte Pine	MPN
Matte Sienna	MSN
Matte Blue Sky	MBS

**Glide Type**

**STANDARD:**

DESCRIPTION	CODE
Nylon	S

**OPTIONAL:**

Please note that optional glides raise the chair height .5 inch.

DESCRIPTION	CODE
Felt	FC

**Stacking note**

The Baraga stool does not stack.

Specifications required to create the product code

- Model
- Wood Species
- Seat Finish
- Frame Finish
- Glide Type

B
A
R
C
-
F
-
P
E
T
1
1
-
B
T
-
S

**MODEL**

Baraga Counter Stool

**SEAT TYPE**

Felt (F)

**SEAT FINISH**

Turmeric (PET11)

**FRAME FINISH**

Black Textured (BT)

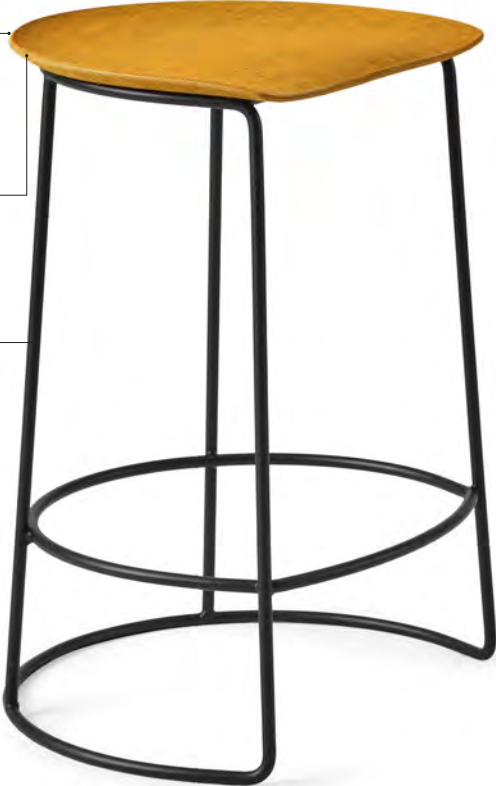

BARAGA STOOL  
Design: Altherr Désile Park

BA5



**Baraga Bar Stool**

	MODEL	SEAT TYPE	LIST PRICE
Powder Coat Frame	BARB-O	Oak	\$1011
W 20 D 16 H 30	BARB-W	Walnut	\$1021
	BARB-F	Felt	\$1037

Optional Glides: Add \$8.00 net per chair for a set of four (4). Optional Glides raise chair height .5 inch.



**Baraga Counter Stool**

	MODEL	SEAT TYPE	LIST PRICE
Powder Coat Frame	BARC-O	Oak	\$980
W 20 D 16 H 25	BARC-W	Walnut	\$999
	BARC-F	Felt	\$1015

Optional Glides: Add \$8.00 net per chair for a set of four (4). Optional Glides raise chair height .5 inch.



**Baraga Low Stool**

	MODEL	SEAT TYPE	LIST PRICE
Powder Coat Frame	BARS-O	Oak	\$966
W 19 D 15 H 18	BARS-W	Walnut	\$977
	BARS-F	Felt	\$992

Optional Glides: Add \$8.00 net per chair for a set of four (4). Optional Glides raise chair height .5 inch.

To specify:  
Please refer to pages 3-4 for complete specifying information.  
Specify all products by their product code.

Pricing Effective: August 2023



---

**5695 Eagle Drive, SE  
Grand Rapids,  
Michigan 49512  
616-975-9260  
lelandfurniture.com**

freshcoast collection  
**BEACH STONES**

2023 Price List

Pricing Effective: January 2023



freshcoast  
by LELAND

**beach stones price list**

---

+ beach stones: table of contents..... BSC2  
+ beach stones specification information ..... BSC3  
+ beach stones specification example..... BSC4  
+ beach stones seating ..... BSC5  
+ beach stone tables..... BSC7

## beach stones specification information

---

### model

---

DESCRIPTION	CODE
Beach Stone E	BSE
Beach Stone E with casters	BSEM
Beach Stone F	BSF
Beach Stone F with casters	BSFM
Beach Stone G	BSG
Beach Stone G with casters	BSGM
Beach Stone H	BSH
Beach Stone I	BSI
Beach Stone J	BSJ
Beach Stone K	BSK
Beach Stone L	BSL

### product weights

---

DESCRIPTION	LBS
Beach Stone E - BSE	50
Beach Stone F - BSF	50
Beach Stone G - BSG	50
Beach Stone H - BSH	50
Beach Stone I - BSI	50
Beach Stone J - BSJ	50
Beach Stone K - BSK	50
Beach Stone L - BSL	50

### upholstery selection

---

Please refer to freshcoast Textile Program which features textiles and leathers from the following partners:

- Camira
- Carnegie
- CF Stinson
- Green Hides
- Maharam
- Unika Vaev

The complete grade list can be found at [www.fc.studio/textile-partners](http://www.fc.studio/textile-partners) or you can specify COM/COL. Due to the design of this product, it is recommended that all non pre-approved textile be tested for compatibility. Contact freshcoast for yardage requirements on textiles with repeats.

### base finish

---

Black textured powder coat

### table top finish

---

#### LAMINATE

DESCRIPTION	CODE
Black Laminate	LBK
White Laminate	LWH

#### SOLID SURFACE

DESCRIPTION	CODE
Black Corian®	CB
White Corian®	CW
Grey Corian®	CG

#### GLASS

DESCRIPTION	CODE
Black Back painted Glass	BG
White Back painted Glass	WG

### caster options

---

Available only on Beach Stone Models E, F, and G.

DESCRIPTION	CODE
Hard Floor	HF
Soft Floor	SF

## SPECIFICATIONS REQUIRED TO CREATE THE PRODUCT CODE

---

- + Model
- + Upholstery Selection
- + Table Top Finish (when applicable)

B S E - C O M - - -  
MODEL UPHOLSTERY SELECTION TABLE TOP FINISH (WHEN APPLICABLE) CASTER OPTION (WHEN APPLICABLE)

### model

---

Beach Stone E (BSE)

### upholstery selection

Upholstered (COM)

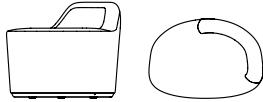

TABLE TOP FINISH  
When applicable

seating



beach stone E	model	com/col	a	b	c	d	e	f	g	h	i	j	k	l
<b>fully upholstered</b>	BSE	\$1538	1720	1812	1904	1995	2087	2178	2269	2361	2452	2543	2636	2727
W32 D24 H25 SH18		COM yardage: 2.5 yds. Contact freshcoast customer care for COL requirements, textile testing requirements and yardage requirements for textiles with repeats.												



beach stone E with casters	model	com/col	a	b	c	d	e	f	g	h	i	j	k	l
<b>fully upholstered, locking caster base</b>	BSEM-HF	\$1604	1786	1878	1970	2061	2153	2244	2335	2427	2518	2609	2702	2793
<b>hard or soft floor casters</b>	BSEM-SF	\$1618	1800	1892	1984	2075	2167	2258	2349	2441	2532	2623	2716	2807
W32 D24 H25.25 SH18.25		COM yardage: 2.5 yds. Contact freshcoast customer care for COL requirements, textile testing requirements and yardage requirements for textiles with repeats.												



beach stone F	model	com/col	a	b	c	d	e	f	g	h	i	j	k	l
<b>fully upholstered</b>	BSF	\$1513	1695	1786	1879	1970	2061	2153	2244	2335	2427	2518	2610	2702
W32 D24 H26 SH18		COM yardage: 2.5 yds. Contact freshcoast customer care for COL requirements, textile testing requirements and yardage requirements for textiles with repeats.												



beach stone F with casters	model	com/col	a	b	c	d	e	f	g	h	i	j	k	l
<b>fully upholstered, locking caster base</b>	BSFM-HF	\$1579	1761	1852	1945	2036	2127	2219	2310	2401	2493	2584	2676	2768
<b>hard or soft floor casters</b>	BSFM-SF	\$1593	1775	1866	1959	2050	2141	2233	2324	2415	2507	2598	2690	2782
W32 D24 H26.25 SH18.25		COM yardage: 2.5 yds. Contact freshcoast customer care for COL requirements, textile testing requirements and yardage requirements for textiles with repeats.												

to specify: please refer to pages 3-4 for complete specifying information. Specify all products by their product code.

seating



beach stone G	model	com/col	a	b	c	d	e	f	g	h	i	j	k	l
<b>fully upholstered</b>	BSG	\$1531	1715	1806	1898	1989	2080	2171	2263	2354	2446	2538	2629	2720
W32 D24 H31 SH18		COM yardage: 2.5 yds. Contact freshcoast customer care for COL requirements, textile testing requirements and yardage requirements for textiles with repeats.												

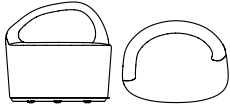

beach stone G with casters	model	com/col	a	b	c	d	e	f	g	h	i	j	k	l
<b>fully upholstered, locking caster base</b>	BSGM-HF	\$1597	1781	1872	1964	2055	2146	2237	2329	2420	2512	2604	2695	2786
<b>hard or soft floor casters</b>	BSGM-SF	\$1611	1795	1886	1978	2069	2160	2251	2343	2434	2526	2618	2709	2800
W32 D24 H31.25 SH18.25		COM yardage: 2.5 yds. Contact freshcoast customer care for COL requirements, textile testing requirements and yardage requirements for textiles with repeats.												



beach stone H	model	com/col	a	b	c	d	e	f	g	h	i	j	k	l
<b>fully upholstered</b>	BSH	\$1020	1202	1294	1386	1477	1569	1660	1751	1843	1934	2025	2118	2209
W48 D18 H18		COM yardage: 2.5 yds. Contact freshcoast customer care for COL requirements, textile testing requirements and yardage requirements for textiles with repeats.												



beach stone I	model	com/col	a	b	c	d	e	f	g	h	i	j	k	l
<b>fully upholstered</b>	BSI	\$919	1041	1101	1162	1223	1284	1345	1406	1466	1528	1588	1650	1711
W33 D22 H18		COM yardage: 1.75 yds. Contact freshcoast customer care for COL requirements, textile testing requirements and yardage requirements for textiles with repeats.												

to specify: please refer to pages 3-4 for complete specifying information. Specify all products by their product code.

tables

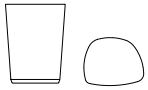

beach stone J	model	top finish	com/col	a	b	c	d	e	f	g	h	i	j	k	l
upholstered w/ table	BSJ	Laminate	\$1074	1134	1165	1195	1225	1256	1287	1317	1348	1378	1408	1439	1470
		Corian	\$1610	1702	1748	1792	1838	1884	1931	1976	2022	2068	2112	2158	2204

W17 D13 H22

COM yardage: 1 yd.

Contact freshcoast customer care for COL requirements, textile testing requirements and yardage requirements for textiles with repeats.

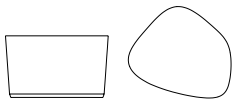

beach stone K	model	top finish	com/col	a	b	c	d	e	f	g	h	i	j	k	l
upholstered w/ table	BSK	Laminate	\$1074	1195	1256	1317	1378	1439	1499	1561	1621	1683	1744	1805	1866
		Corian	\$1610	1792	1884	1976	2068	2158	2250	2342	2432	2525	2616	2708	2798

W30 D27 H18

COM yardage: 2 yds.

Contact freshcoast customer care for COL requirements, textile testing requirements and yardage requirements for textiles with repeats.

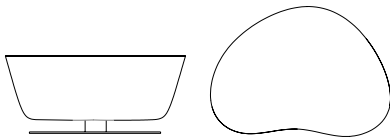

beach stone L	model	top finish	com/col	a	b	c	d	e	f	g	h	i	j	k	l
upholstered w/ table	BSL	Laminate	\$3358	3541	3632	3724	3815	3906	3997	4089	4181	4272	4364	4455	4546
		Corian	\$5038	5312	5448	5586	5722	5860	5996	6134	6272	6409	6546	6683	6820

W47 D34 H20

COM yardage: 3 yds.

Contact freshcoast customer care for COL requirements, textile testing requirements and yardage requirements for textiles with repeats.

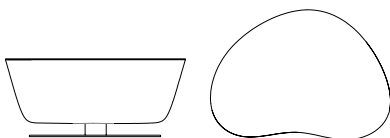

beach stone L	model	com/col	a	b	c	d	e	f	g	h	i	j	k	l
upholstered w/ backpainted glass	BSL	\$3664	3847	3938	4029	4121	4212	4304	4396	4487	4578	4670	4761	4852

W47 D34 H20

COM yardage: 3 yds.

Contact freshcoast customer care for COL requirements, textile testing requirements and yardage requirements for textiles with repeats.

to specify: please refer to pages 3-4 for complete specifying information. Specify all products by their product code.



# Brit Bench Metallic

## January 2023 Price List

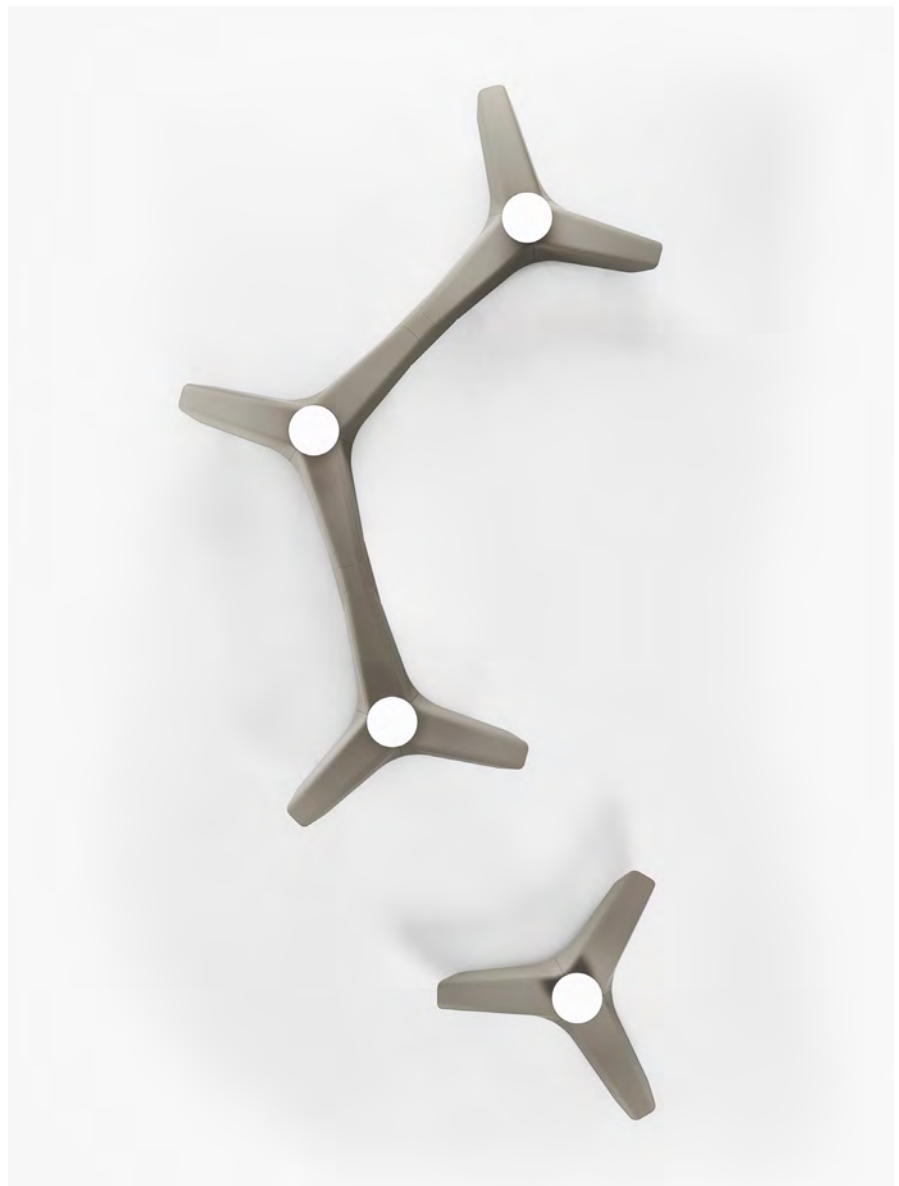

# Brit Bench Metallic

Table of Contents	BBM2
Specification Information	BBM3
Specification Example	BBM4
Powder Coat Steel, Upholstered Seat Onlay	BBM5
Auxiliary Options	BBM6
Link Specification Information	BBM7
Link Specification Example	BBM8
Brit Bench Metallic Link	BBM9
Auxiliary Options	BBM10

## Bench Model

DESCRIPTION	CODE
Brit Bench metallic powder coat steel	BBPC
Brit Bench metallic powder coat steel, with powder coat steel table	BBPCT
Brit Bench metallic powder coat steel, upholstered onlay	BBPCU with
Brit Bench metallic powder coat steel, with powder steel table, with upholstered onlay	BBPCTU coat

## Leg Finish

DESCRIPTION	CODE
Brushed Stainless Steel	BSS
Black Powder Coat	BPC

## Powder Coat Steel Finish

DESCRIPTION	CODE
Black Textured Powder Coat	BT
Grey Textured Powder Coat	GT
Soda Red Textured	SRT
Dolphin Textured	DLT
Oxford Textured	OXT
Tangerine Textured	TNT
Ice Blue Textured	IBT
Artic Textured	ART
Caribbean Textured	CBT
Limelight Textured	LLT
Ink Textured	IN

## Upholstered Onlay Selection

Please refer to Leland Textile Program which features textiles and leathers from the following partners:

- Camira
- Carnegie
- CF Stinson
- Green Hides
- Maharam
- Unika Vaev

The complete grade list can be found on our website or you can specify COM/COL. Due to the design of this product, it is recommended that all non pre-approved textile be tested for compatibility.

Upholstered onlay is not an option for the Brit Bench Metallic link.

## Table Top Surface

DESCRIPTION	CODE
Corian® Solid Surface Solid with 0.5" square edge	SSS

Contact Corian® Solid Surface for current solid and pattern availability. A custom quote is required for all solid surface. Please contact Leland Customer Experience to request a custom quote.

## Auxiliary Options

DESCRIPTION	CODE
Brit Bench Electrical outlets, (with table)	BBE0
Brit Bench Floor Mount	BBFM
Brit Bench Security Pan	BSP
Outdoor Treatment	OT

## Glides

Brit Bench glides are nylon.

## Product Specification

Brit Bench product layout is required at the quotation stage and order stage to ensure accurate product specifications. Contact Leland Customer Experience for CAD symbols.

## Shipment Detail

Please note that Brit Bench products will be shipped unassembled. Please contact Customer Experience if assembled shipment is desired as additional charges will apply.

**Specifications required to create the product code**

**BRIT BENCH METALLIC (WITHOUT TABLE)**

- Model
- Leg Finish
- Powder Coat Steel Finish (when applicable)
- Upholstery Selection (when applicable)
- Auxiliary Options (when applicable)



**BRIT BENCH METALLIC (WITH TABLE)**

- Model
- Leg Finish
- Powder Coat Steel Finish (when applicable)
- Upholstered Onlay Selection (when applicable)
- Table Top Surface
- Surface Color (when applicable)
- Auxiliary Options (when applicable)

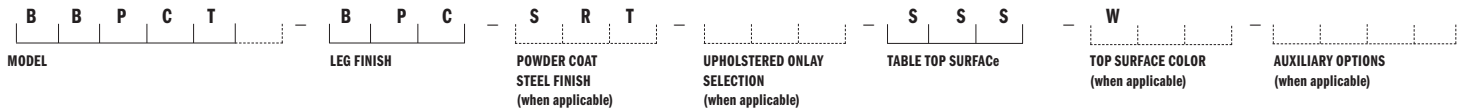

**MODEL**

Brit Bench Metallic Powder Coat Steel, with Powder Coat Steel Table (BBPCT)

**LEG FINISH**

Brushed Stainless Steel (BPC)

**POWDER COAT STEEL FINISH**

Soda Red Textured (SRT)

**UPHOLSTERED ONLAY SELECTION**

When applicable, enter upholstery grade, COM or COL

**TABLE TOP SURFACE**

SSS

**TOP SURFACE COLOR**

Corian® White Solid Surface (CW)

**AUXILIARY OPTIONS**

When applicable, enter auxiliary option code

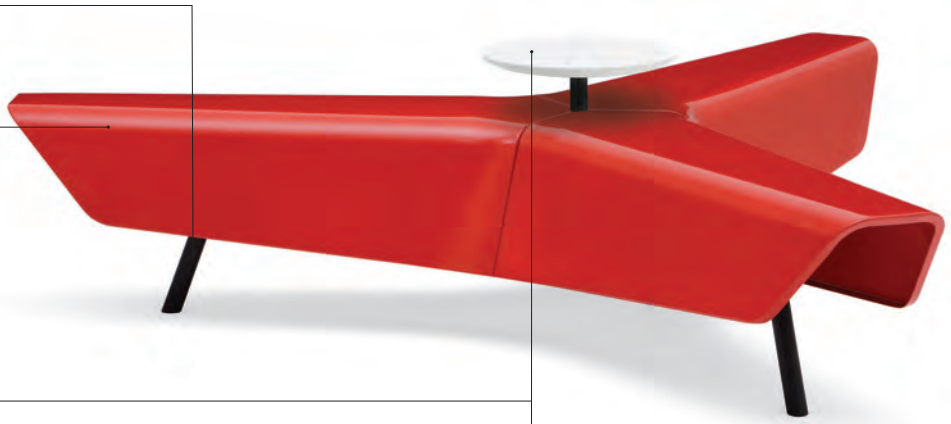

**BRIT BENCH METALLIC POWDER COAT STEEL**  
Design: Simon Pengelly

**BBM5**



<b>Brit Bench Metallic</b>	<b>MODEL</b>	<b>LIST PRICE</b>
Powder coat steel	BBPC 1-3 units	\$10090
W 81 SH 18.5	BBPC 4+ units	\$8691

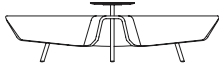

<b>Brit Bench Metallic</b>	<b>MODEL</b>	<b>LIST PRICE</b>
Powder coat steel, steel table	BBPCT 1-3 units	\$11583
W 81 SH 18.5	BBPCT 4+ units	\$10182

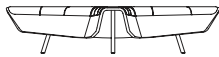

<b>Brit Bench Metallic</b>	<b>MODEL</b>	<b>LIST PRICE/GRADE</b>	<b>COM/</b>												
			<b>COL</b>	<b>A</b>	<b>B</b>	<b>C</b>	<b>D</b>	<b>E</b>	<b>F</b>	<b>G</b>	<b>H</b>	<b>I</b>	<b>J</b>	<b>K</b>	<b>L</b>
Powder coat steel upholstered seat onlay	BBPCU 1-3 units	\$ 10798	11107	11265	11419	11575	11733	11888	12044	12200	12356	12511	12669	12824	
	BBPCU 4+ units	\$ 9396	9708	9863	10019	10175	10331	10486	10644	10799	10955	11112	11267	11424	

W 81 SH 19.5

COM Yardage: 1 bench: 4 yards  
For COL requirements please contact Leland Customer Experience.



<b>Brit Bench Metallic</b>	<b>MODEL</b>	<b>LIST PRICE/ GRADE</b>	<b>COM/</b>												
			<b>COL</b>	<b>A</b>	<b>B</b>	<b>C</b>	<b>D</b>	<b>E</b>	<b>F</b>	<b>G</b>	<b>H</b>	<b>I</b>	<b>J</b>	<b>K</b>	<b>L</b>
Powder coat steel, steel table upholstered seat onlay	BBPCTU 1-3 units	\$ 12286	12597	12753	12911	13066	13222	13378	13534	13690	13847	14002	14158	14313	
	BBPCTU 4+ units	\$ 10888	11198	11353	11510	11666	11822	11979	12133	12289	12445	12602	12757	12914	

W 81 SH 19.5

COM Yardage: 1 bench: 4 yards  
For COL requirements please contact Leland Customer Experience.

<b>Brit Bench Table Top</b>	<b>MODEL</b>
Corian® Solid Surface Circular Top	SSS

Contact Corian® Solid Surface for current solid and pattern availability. A custom quote is required for all solid surface. Please contact Leland Customer Experience to request a custom quote.

**To specify:**  
Please refer to pages 3-4 for complete specifying information. Specify all products by their product code.

**Pricing Effective: January 2023**

**BRIT BENCH METALLIC AUXILIARY OPTIONS**

Design: Simon Pengelly

# BBM6

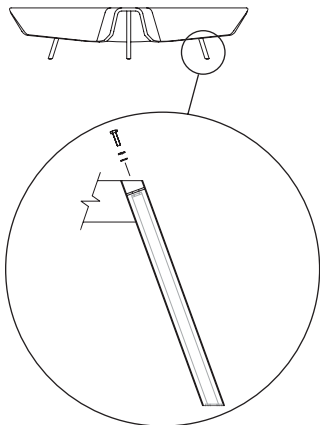

<b>Brit Bench Floor Mount</b>	<b>MODEL</b>	<b>LIST PRICE</b>
	BBFM	\$210

Due to the variety of floor surfaces on which the Brit Bench may be installed, floor mount fasteners are not supplied by Leland International. The Brit Bench floor mount feature consists of legs with floor mount brackets designed to use .3125 thread diameter fasteners. Responsibility of fastener choice is the customers. Brit Bench Floor Mount must be specified at the time of purchasing. The Floor Mount cannot be added later in the field.

<b>Brit Bench Security Pan</b>	<b>MODEL</b>	<b>LIST PRICE</b>
	BBSP	\$1761

<b>Brit Bench Electrical Outlet</b>	<b>MODEL</b>	<b>LIST PRICE</b>
For table	BBEO	\$1166

Brit Bench electrical outlet option is not standard for all Brit Bench tables. Electrical outlet is located under the table edge, therefore a Brit Bench with table must be specified when specifying electrical outlet option. Brit Bench electrical outlet option features one 120v AC receptacle.

<b>Outdoor Treatment</b>	<b>MODEL</b>	<b>LIST PRICE</b>
powder coat steel bench	OT	\$388

**To specify:**  
 Please refer to pages 3-4 for complete specifying information.  
 Specify all products by their product code.

## Link Model

---

DESCRIPTION	CODE
Brit Bench Metallic Link powder coat steel	BBLPC

## Powder Coat Steel Finish

---

DESCRIPTION	CODE
White Textured Powder Coat	WT
Black Textured Powder Coat	BT
Grey Textured Powder Coat	GT
Soda Red Textured	SRT
Dolphin Textured	DLT
Oxford Textured	OXT
Tangerine Textured	TNT
Ice Blue Textured	IBT
Artic Textured	ART
Caribbean Textured	CBT
Limelight Textured	LLT
Ink Textured	IN

## Auxiliary Options

---

DESCRIPTION	CODE	DESCRIPTION	CODE
Brit Bench Link Security Pan			BBLSP
Outdoor Treatment			OT

## Product Specification

---

Brit Bench product layout is required at the quotation stage and order stage to ensure accurate product specifications. Contact Leland Customer Experience for CAD symbols.

## Shipment Details

---

Please note that Brit Bench products will be shipped unassembled.  
Please contact Customer Experience if assembled shipment is desired as additional charges will apply.

**Specifications required to create the product code**

- Model
- Powder Coat Steel Finish (when applicable)
- Upholstery Selection (when applicable)
- Outdoor Treatment (when applicable)
- Auxiliary Options (when applicable)



**MODEL**

Brit Bench Metallic Link Powder Coat Steel (BBLPC)

**POWDER COAT STEEL FINISH**

Artic Textured (ART)

**OUTDOOR TREATMENT**

When applicable

**AUXILIARY OPTIONS**

When applicable, enter auxiliary option code

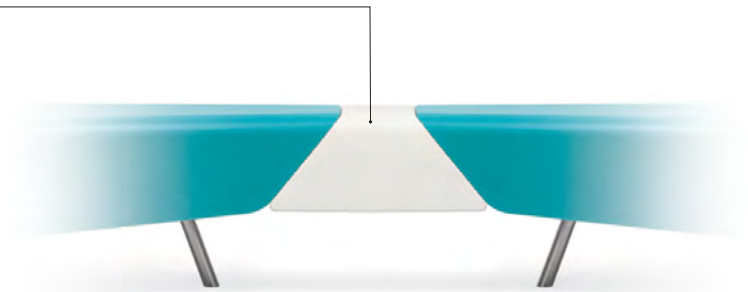



**BRIT BENCH METALLIC LINK**  
Design: Simon Pengelly

# BBM9

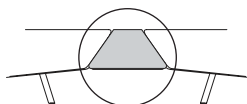

<b>Brit Bench Metallic Link</b>	<b>MODEL</b>	<b>FRAME FINISH</b>	<b>LIST PRICE</b>
powder coat steel link	BBLPC		\$1184

W 7.875

Upholstered onlay is not an option for the Brit Bench Metallic Powder Coat Steel Link.

**To specify:**  
Please refer to pages 3-4 for complete specifying information.  
Specify all products by their product code.

**Pricing Effective: January 2023**

<b>Brit Bench Link Security Pan</b>	<b>MODEL</b>	<b>FRAME FINISH</b>	<b>LIST PRICE</b>
	BBLSP		\$396

Brit Bench Link Security Pan must be specified at the time of purchasing.  
The Link Security Pan cannot be added later in the field.

<b>Outdoor Treatment</b>	<b>MODEL</b>	<b>FRAME FINISH</b>	<b>LIST PRICE</b>
powder coat steel link	OT		\$130

To specify:  
Please refer to pages 3-4 for  
complete specifying information.  
Specify all products by their  
product code.

---

**5695 Eagle Drive, SE  
Grand Rapids,  
Michigan 49512  
616-975-9260  
lelandfurniture.com**

# Café Parfait

## January 2023 Price List



# Café Parfait

Table of Contents	CP2
Specification Information	CP3
Specification Example	CP4
Side Chair	CP5
Counter Chair	CP6
Bar Chair	CP7
Transport/Stacking Dolly	CP8

## Chair Model

DESCRIPTION	CODE
Café Parfait side chair, upholstered seat, wood back	CPSUW
Café Parfait side chair, wood seat, wood back	CPSWW
Café Parfait counter chair, upholstered seat, wood back	CPCUW
Café Parfait counter chair, wood seat, wood back	CPCWW
Café Parfait bar chair, upholstered seat, wood back	CPBUW
Café Parfait bar chair, wood seat, wood back	CPBWW

## Upholstery Selection

### POLYPROPYLENE SHELL:

Please refer to Leland Textile Program which features textiles and leathers from the following partners:

- Camira
- Green Hides
- Carnegie
- Maharam
- CF Stinson
- Unika Vaev

The complete grade list can be found on our website or you can specify COM/COL. Due to the design of this product, it is recommended that all non pre-approved textile be tested for compatibility.

## Seat and Back Wood Finish

### STANDARD LELAND COLORS

**CUSTOM** Specify Custom (01)

\*Please note that Café Parfait is NOT AVAILABLE in the following finishes:  
Natural Walnut Matte (08M), Natural Beech (09), Natural White Oak Matte (12M)

## Frame Finishes

DESCRIPTION	CODE
Sterling	ST
Warm Grey	WG
Cool Grey	CG
Black	B
White	W
Matte Mercury	MMR
Matte Mineral	MMN
Matte Burnish	MBN
Matte Foundry	MFN

### TEXTURED

DESCRIPTION	CODE
Dolphin Textured	DLT
Oxford Textured	OXT
Grey Textured	GT
Black Textured	BT
White Textured	WT
Matte Blue Sky	MBS
Matte Forest	MFO
Matte Sienna	MSN
Matte Willow	MWL

## Glide Type

### STANDARD:

DESCRIPTION	CODE
Nylon	S

### OPTIONAL:

DESCRIPTION	CODE
Felt	FC
Floor Saver™ (for VCT type floors)	FS
Metal	M
Rubber	R

Please note that optional glides raise the chair height .5 inch.

**Specifications required to create the product code**

- Model
- Seat Upholstery or Finish
- Back Finish
- Frame Finish
- Glide Type



**MODEL**

Café Parfait Side Chair -  
wood seat, wood back  
(CPSWW)

**SEAT UPHOLSTERY OR FINISH**

Aegean (78)

**BACK FINISH**

Sea Grass (79)

**FRAME FINISH**

Sterling (ST)



CAFÉ PARFAIT SIDE CHAIR  
 Design: Leland Design Group

CP5



Café Parfait Side Chair	MODEL	LIST PRICE
Wood seat wood back,	CPSWW	\$664

W 19 D 20 H 31 SH 19

Optional Glides: Add \$8.00 net per chair for a set of four (4). Optional Glides raise chair height .5 inch.



Café Parfait Side Chair	MODEL	LIST PRICE/GRADE	COM/COL	A	B	C	D	E	F	G	H	I	J	K	L
3D Beech veneer shell, upholstered seat onlay	CPSUW		\$618	650	668	685	702	719	738	755	773	790	807	824	842

W 19 D 20 H 31 SH 19

Optional Glides: Add \$8.00 net per chair for a set of four (4). Optional Glides raise chair height .5 inch.  
 COM Yardage: 1 or 2 seats: .75 yard; 3 or 4 seats: 1.25 yards  
 Contact Leland Customer Experience for yardage requirements on textiles with repeats.  
 For COL requirements please contact Leland Customer Experience.

To specify:  
 Please refer to pages 3-4 for  
 complete specifying information.  
 Specify all products by their  
 product code.

Pricing Effective: January 2023



**CAFÉ PARFAIT COUNTER CHAIR**  
 Design: Leland Design Group

**CP6**

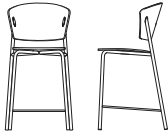

<b>Café Parfait Counter Chair</b>	<b>MODEL</b>	<b>LIST PRICE</b>
Wood seat wood back,	CPCWW	\$918

W 18.5 D 23 H 37.75 SH 25

Optional Glides: Add \$8.00 net per chair for a set of four (4). Optional Glides raise chair height .5 inch.

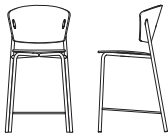

<b>Café Parfait Counter Chair</b>	<b>MODEL</b>	<b>LIST PRICE/GRADE</b>	<b>COM/COL</b>	<b>A</b>	<b>B</b>	<b>C</b>	<b>D</b>	<b>E</b>	<b>F</b>	<b>G</b>	<b>H</b>	<b>I</b>	<b>J</b>	<b>K</b>	<b>L</b>
3D Beech veneer shell, upholstered seat onlay	CPCUW	\$877	907	925	942	960	977	994	1012	1030	1047	1065	1082	1099	

W 18.5 D 23 H 37.75  
 SH 25.5

Optional Glides: Add \$8.00 net per chair for a set of four (4). Optional Glides raise chair height .5 inch.  
 COM Yardage: 1 or 2 seats: .75 yard; 3 or 4 seats: 1.25 yards  
 Contact Leland Customer Experience for yardage requirements on textiles with repeats.  
 For COL requirements please contact Leland Customer Experience.

**To specify:**  
 Please refer to pages 3-4 for  
 complete specifying information.  
 Specify all products by their  
 product code.

**Pricing Effective: January 2023**

**CAFÉ PARFAIT BAR CHAIR**  
 Design: Leland Design Group

**CP7**

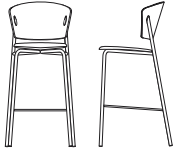

<b>Café Parfait Bar Chair</b>	<b>MODEL</b>	<b>LIST PRICE</b>
Wood seat wood back,  W 19 D 20 H 43 SH 29.5	CPBWW	\$938

Optional Glides: Add \$8.00 net per chair for a set of four (4). Optional Glides raise chair height .5 inch.

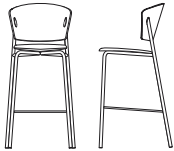

<b>Café Parfait Bar Chair</b>	<b>MODEL</b>	<b>LIST PRICE/GRADE</b>	<b>COM/COL</b>	<b>A</b>	<b>B</b>	<b>C</b>	<b>D</b>	<b>E</b>	<b>F</b>	<b>G</b>	<b>H</b>	<b>I</b>	<b>J</b>	<b>K</b>	<b>L</b>
3D Beech veneer shell, upholstered seat onlay  W 19 D 20 H 43 SH 30	CPBUW		\$894	925	942	960	977	994	1012	1030	1047	1065	1082	1099	1116

Optional Glides: Add \$8.00 net per chair for a set of four (4). Optional Glides raise chair height .5 inch.  
 COM Yardage: 1 or 2 seats: .75 yard; 3 or 4 seats: 1.25 yards  
 Contact Leland Customer Experience for yardage requirements on textiles with repeats.  
 For COL requirements please contact Leland Customer Experience.

**To specify:**  
 Please refer to pages 3-4 for  
 complete specifying information.  
 Specify all products by their  
 product code.

**Pricing Effective: January 2023**

CAFÉ PARFAIT TRANSPORT/STACKING DOLLY  
Design: Leland Design Group

CP8

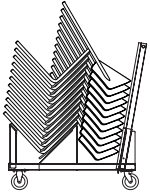

**Café Parfait Transport/  
Stacking Dolly**

	MODEL		LIST PRICE
W 19 D 43 H 45 (Empty)	CPD	Black Finish	\$989
W 19 D 43 H 67 (With 10 side chairs)		Café Parfait Transport/Stacking Dolly handles up to 10 Café Parfait side chairs.	

To specify:  
Please refer to pages 3-4 for  
complete specifying information.  
Specify all products by their  
product code.

Pricing Effective: January 2023

---

**5695 Eagle Drive, SE  
Grand Rapids,  
Michigan 49512  
616-975-9260  
lelandfurniture.com**

# Cambre Table

## January 2023 Price List

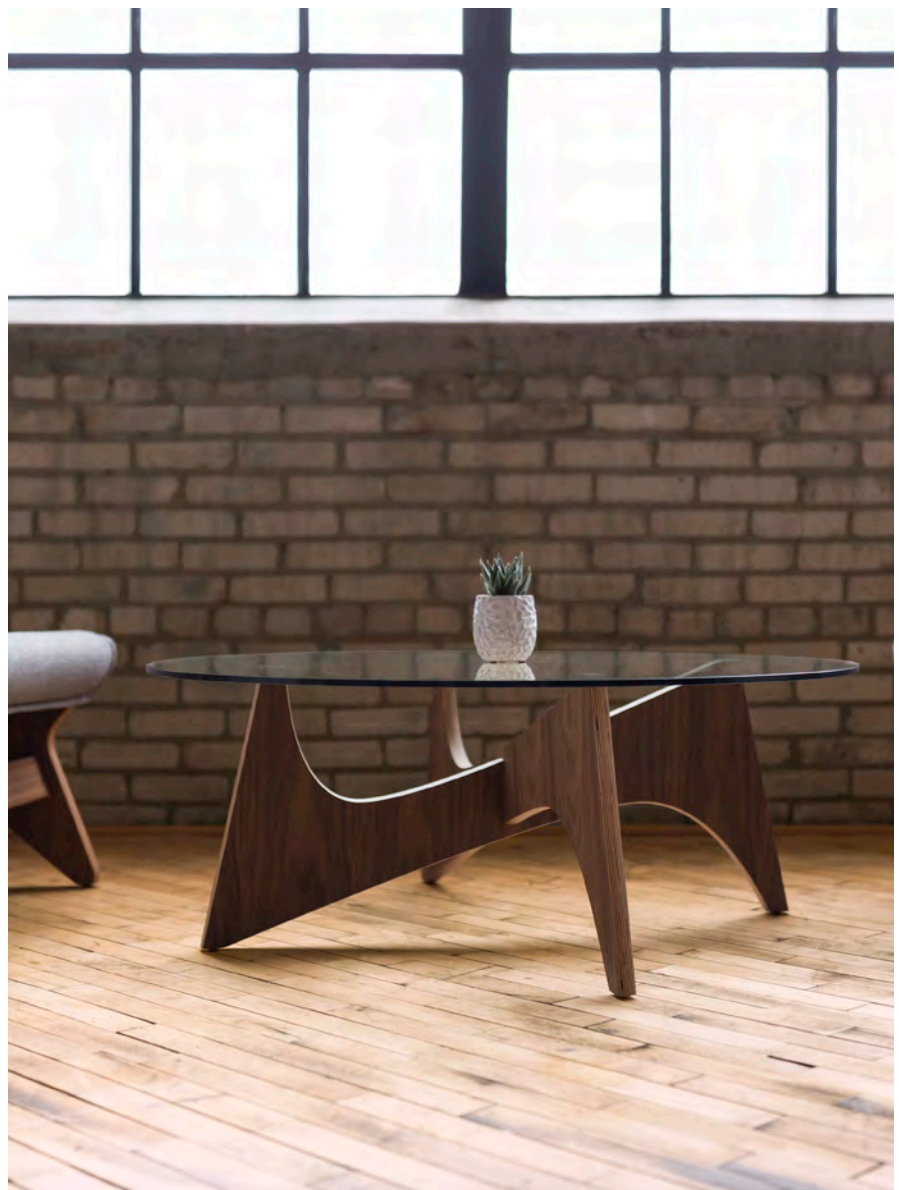

# Cambre Table

Table of Contents	CA2
Specification Information	CA3
Specification Example	CA4
Table 16"	CA5
Table 22"	CA5

**Table Model**

DESCRIPTION	CODE
Cambre Table	CA

**Table Height**

DESCRIPTION	CODE
16"	16H
22"	22H

**Base Finish**

DESCRRIPTION	CODE
Natural Walnut	08M
Natural Ash	07M

Maple in Standard Leland Colors

**LELAND COLORS**

**Top Size**

DESCRRIPTION	CODE
16" H Table	
42" Round	42D
34" Square	3434
22" H Table	
18" Round	18D
16" Square	1616

**Top Surface Option**

DESCRRIPTION	CODE
16" H Table	
Clear Glass	G
22" H Table	
Clear Glass	G

**Glide Selection**

DESCRRIPTION	CODE
Nylon (standard)	S
Felt	F

**Specifications required to create the product code**

- Model
- Table Height
- Base Finish Selection
- Top Size
- Top Surface
- Glide Selection

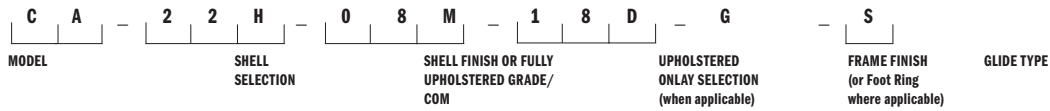

**MODEL**

Cambre Table (CA)

**TABLE HEIGHT**

22" (22H)

**BASE FINISH**

Natural Walnut (08M)

**TOP SIZE**

18" Round (18D)

**TOP SURFACE**

Glass (G)

**GLIDE SELECTION**

Nylon (S)





**CAMBRE TABLE**  
Design: Bruce Sienkowski

**CA5**

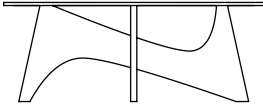

<b>Cambre</b>	<b>MODEL</b>	<b>CLEAR GLASS</b>
Cambre Occasional Table, 42" Round Top	CA-16H-42D	\$2239
W 42 D 42 H 16	Optional Glides: Add \$8.00 net per table for a set of four (4).	

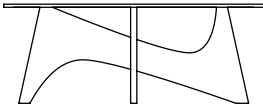

<b>Cambre</b>	<b>MODEL</b>	<b>CLEAR GLASS</b>
Cambre Occasional Table, 34" Square Top	CA-16H-3434	\$1770
W 34 D 34 H 16	Optional Glides: Add \$8.00 net per table for a set of four (4).	

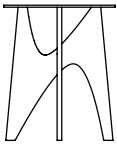

<b>Cambre</b>	<b>MODEL</b>	<b>CLEAR GLASS</b>
Cambre Side Table, 18" Round Top	CA-22H-18D	\$1784
W 18 D 18 H 22	Optional Glides: Add \$8.00 net per table for a set of four (4).	

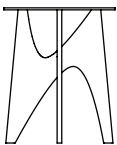

<b>Cambre</b>	<b>MODEL</b>	<b>CLEAR GLASS</b>
Cambre Side Table, 16" Square Top	CA-22H-1616	\$1406
W 16 D 16 H 22	Optional Glides: Add \$8.00 net per table for a set of four (4).	

**To specify:**  
Please refer to pages 3-4 for complete specifying information. Specify all products by their product code.

---

**5695 Eagle Drive, SE  
Grand Rapids,  
Michigan 49512  
616-975-9260  
lelandfurniture.com**

# Ease

## January 2023 Price List



# Ease

Table of Contents	ES2
Specification Information	ES3
Specification Example	ES4
Side Chair	ES5
Transport/Stacking Dolly	ES7

**Chair Model**

DESCRIPTION	CODE
Ease side chair, upholstered seat, wood back	ESSUW
Ease side chair ganging, upholstered seat , wood back	ESSGUW
Ease side chair, upholstered seat, wood back upholstered back onlay	ESSUWU
Ease side chair ganging, upholstered seat wood back, upholstered back onlay	ESSGUWU
Ease side chair, wood seat, wood back	ESSWW
Ease side chair ganging, wood seat wood back	ESSGWW

**Seat and Back Wood Finish****STANDARD LELAND COLORS****CUSTOM** Specify Custom (01)

\*Please note that Ease is NOT AVAILABLE in the following finishes:

**Upholstery Selection**

Please refer to Leland Textile Program which features textiles and leathers from the following partners:

- Camira
- Carnegie
- CF Stinson
- Green Hides
- Maharam
- Unika Vaev

The complete grade list can be found on our website or you can specify COM/COL. Due to the design of this product, it is recommended that all non pre-approved textile be tested for compatibility.

**Frame Finish: Powdercoat and Chrome**

DESCRIPTION	CODE
Sterling	ST
Warm Grey	WG
Cool Grey	CG
Black	B
White	W
Matte Mercury	MMR
Matte Mineral	MMN
Matte Burnish	MBN
Matte Foundry	MFN
Chrome	C
Matte Blue Sky	MBS
Matte Forest	MFO
Matte Sienna	MSN
Matte Willow	MWL
<b>TEXTURED</b>	<b>CODE</b>
Dolphin Textured	DLT
Oxford Textured	OXT
Grey Textured	GT
Black Textured	BT
White Textured	WT

**Auxiliary Options**

GLIDES	DESCRIPTION	CODE
	Polycarbonate	P
	Felt	F

Please note that adding glides raises the chair height.25 inch.

**Specifications required to create the product code**

- Model
- Seat Upholstery or Finish
- Back Finish
- Upholstered Back Onlay (when applicable)
- Frame Finish
- Auxiliary Options (when applicable)



**MODEL**

Ease Side Chair, upholstered seat, wood back, upholstered back onlay (ESSUWU)

**SEAT UPHOLSTERY OR FINISH**

Grade H (H)

**BACK FINISH**

Natural (11)

**UPHOLSTERED BACK ONLAY**

Grade H (H)

**FRAME FINISH**

Chrome (C)



**EASE SIDE CHAIR**  
Design: Leland Design Group

**ES5**



**Ease Side Chair**

	MODEL	LIST PRICE/GRADE	COM/COL	A	B	C	D	E	F	G	H	I	J	K	L
Upholstered seat, wood back	ESSUW		\$595	627	644	660	677	693	710	727	742	759	776	792	809
W 19.5 D 21.75 H 31 SH 18.5															
Glides: Add \$8.00 net per chair for a set of four (4). COM Yardage: 1 or 2 seats: .75 yard, 3 or 4 seats: 1.5 yards, 5 or 6 seats: 2.25 yards. Contact Leland Customer Experience for yardage requirements on textiles with repeats. For COL requirements please contact Leland Customer Experience.															



**Ease Side Chair, Ganging**

	MODEL	LIST PRICE/GRADE	COM/COL	A	B	C	D	E	F	G	H	I	J	K	L
Upholstered seat, wood back	ESSGUW		\$644	675	692	709	725	741	758	775	791	807	824	840	857
W 19.5 D 21.75 H 31 SH 18.5															
Glides: Add \$8.00 net per chair for a set of four (4). COM Yardage: 1 or 2 seats: .75 yard, 3 or 4 seats: 1.5 yards, 5 or 6 seats: 2.25 yards. Contact Leland Customer Experience for yardage requirements on textiles with repeats. For COL requirements please contact Leland Customer Experience.															



**Ease Side Chair**

	MODEL	LIST PRICE/GRADE	COM/COL	A	B	C	D	E	F	G	H	I	J	K	L
Upholstered seat, wood back upholstered back onlay	ESSUWU		\$631	663	679	695	712	729	746	761	778	795	811	827	845
W 19.5 D 21.75 H 31 SH 18.5															
Glides: Add \$8.00 net per chair for a set of four (4). COM Yardage: 1 seat and back: .75 yard, 6 seats and backs: 3.5 yards Contact Leland Customer Experience for yardage requirements on textiles with repeats. For COL requirements please contact Leland Customer Experience.															



**Ease Side Chair, Ganging**

	MODEL	LIST PRICE/GRADE	COM/COL	A	B	C	D	E	F	G	H	I	J	K	L
Upholstered seat, wood back upholstered back onlay	ESSGUWU		\$748	779	796	812	830	846	863	879	896	912	928	945	962
W 19.5 D 21.75 H 31 SH 18.5															
Glides: Add \$8.00 net per chair for a set of four (4). COM Yardage: 1 seat and back: .75 yard, 6 seats and backs: 3.5 yards Contact Leland Customer Experience for yardage requirements on textiles with repeats. For COL requirements please contact Leland Customer Experience.															

**To specify:**  
Please refer to pages 3-4 for complete specifying information.  
Specify all products by their product code.

**Pricing Effective: January 2023**

EASE SIDE CHAIR  
Design: Leland Design Group

ES6

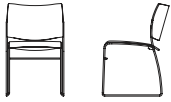

<b>Ease Side Chair</b>	<b>MODEL</b>	<b>LIST PRICE</b>
Wood seat wood back,	ESSWW	\$611
W 19.5 D 21.75 H 31 SH 18	Glides: Add \$8.00 net per chair for a set of four (4).	



<b>Ease Side Chair, Ganging</b>	<b>MODEL</b>	<b>LIST PRICE</b>
Wood seat wood back,	ESSGWW	\$644
W 19.5 D 21.75 H 31 SH 18	Glides: Add \$8.00 net per chair for a set of four (4).	

To specify:  
Please refer to pages 3-4 for  
complete specifying information.  
Specify all products by their  
product code.

Pricing Effective: January 2023



EASE TRANSPORT/STACKING DOLLY  
Design: Leland Design Group

ES7

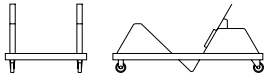

**Ease Transport/  
Stacking Dolly**

	MODEL	LIST PRICE
W 22.75 D 46.5 H 14.25 (empty)	ESSNDB	\$1055

Ease Transport/Stacking Dolly handles up to 25 side chairs in wood or 15 side chairs upholstered.

To specify:  
Please refer to pages 3-4 for  
complete specifying information.  
Specify all products by their  
product code.

Pricing Effective: January 2023

---

**5695 Eagle Drive, SE  
Grand Rapids,  
Michigan 49512  
616-975-9260  
lelandfurniture.com**

# Ebb Bench Fully Upholstered

## January 2023 Price List



# Ebb Fully Upholstered

Table of Contents	EB2
Specification Information	EB3
Specification Example	EB4
Two Closed Ends	EB5
One Linking End	EB6
Two Linking Ends	EB7
Auxiliary Options	EB8
Hub Specification Information	EB9
Hub Specification Example	EB10
Hub	EB11
Hub Auxiliary Options	EB12
Pod Specification Information	EB13
Pod Specification Example	EB14
Pod	EB15
Pod Auxiliary Options	EB16

**Bench Model**

DESCRIPTION	CODE
Ebb fully upholstered bench, two closed ends	EBFUCC
Ebb fully upholstered bench, one linking end	EBFUCL
Ebb fully upholstered bench, two linking ends	EBFULL

**Bench Length**

DESCRIPTION	CODE
30" Long	30
48" Long	48
72" Long	72
96" Long	96
120" Long	120

**Fully Upholstered Selection**

Please refer to Leland Textile Program which features textiles and leathers from the following partners:

- Camira
- Carnegie
- CF Stinson
- Green Hides
- Maharam
- Unika Vaev

The complete grade list can be found at [www.lelandfurniture.com/resources](http://www.lelandfurniture.com/resources) or you can specify COM/COL. All non pre-approved textiles need be tested for compatibility.

Due to upholstery requirements, the Ebb product line can only be upholstered railroaded. Please consider when specifying textiles with a pattern. Untested COM or COL textiles will not be accepted.

**Leg Finish**

Ebb fully upholstered linking benches have black powder coat skirts.

DESCRIPTION	CODE
Sterling	ST
Warm Grey	WG
Cool Grey	CG
Black	B
White	W
Matte Mercury	MMR
Matte Mineral	MMN
Matte Burnish	MBN
Matte Foundry	MFN
Black Textured	BT
Grey Textured	GT
White Textured	WT
Chrome	C

**Auxiliary Options**

Auxiliary Options must be specified at the time of the order.

**SKIRT:**

DESCRIPTION	CODE
Ebb Fully Upholstered Bench Skirt	SK

**FLOOR MOUNT:**

DESCRIPTION	CODE
Ebb Fully Upholstered Bench Floor Mount	FM
*Floor Mount requires Skirt.	

**Glides**

Ebb glides are nylon

**Product Specification**

Ebb layout is required at the quotation stage and order stage to ensure accurate product specifications. Contact Leland Customer Experience for CAD drawings.

## Specifications required to create the product code

- Model
- Bench Length
- Upholstery Selection
- Leg Finish
- Skirt (when applicable)
- Floor Mount (when applicable)



### MODEL

Ebb Fully Upholstered Bench  
Two Closed Ends (EBFUCC)

### BENCH LENGTH

72" (72)

### UPHOLSTERY SELECTION

Enter upholstery grade,  
COM or COL (COM)

### LEG FINISH

Specify Standard Powder Coat

### SKIRT

When Applicable, enter skirt code

### FLOOR MOUNT

When Applicable, enter Ebb floor  
mount code. Floor Mount requires Skirt.



# EBB FULLY UPHOLSTERED BENCH TWO CLOSED ENDS

Design: Mark Gabbartas

# EB5

Ebb Fully Upholstered Bench Two Closed Ends Skirt must be specified at the time of ordering. Skirt cannot be added later in the field.



## Ebb Fully Upholstered Bench Two Closed Ends

	MODEL	LIST PRICE/GRADE	COM/COL	A	B	C	D	E	F	G	H	I	J	K	L
30" long	EBFUCC-30		\$2318	2522	2665	2814	2967	3122	3285	3451	3622	3798	3981	4169	4362

W 17.5 L 18.5

COM Yardage: 1.75 yards  
For COL requirements please contact Leland Customer Care.

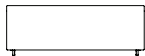

## Ebb Fully Upholstered Bench Two Closed Ends

	MODEL	LIST PRICE/GRADE	COM/COL	A	B	C	D	E	F	G	H	I	J	K	L
48" long	EBFUCC-48		\$3054	3340	3537	3741	3950	4166		4617	4853	5096	5346	5605	5870

W 17.5 L 18.5

COM Yardage: 2.75 yards  
For COL requirements please contact Leland Customer Care.

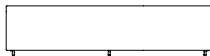

## Ebb Fully Upholstered Bench Two Closed Ends

	MODEL	LIST PRICE/GRADE	COM/COL	A	B	C	D	E	F	G	H	I	J	K	L
72" long	EBFUCC-72		\$3790	4146	4391	4645	4906	5173	5451	5735	6029	6332	6643	6963	7293

W 17.5 L 18.5

COM Yardage: 4.25 yards  
For COL requirements please contact Leland Customer Care.

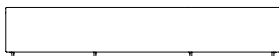

## Ebb Fully Upholstered Bench Two Closed Ends

	MODEL	LIST PRICE/GRADE	COM/COL	A	B	C	D	E	F	G	H	I	J	K	L
96" long	EBFUCC-96		\$4524	4976	5284	5601	5928	6265	6611	6969	7336	7714	8105	8506	8921

W 17.5 L 18.5

COM Yardage: 5.5 yards  
For COL requirements please contact Leland Customer Care.



## Ebb Fully Upholstered Bench Two Closed Ends

	MODEL	LIST PRICE/GRADE	COM/COL	A	B	C	D	E	F	G	H	I	J	K	L
120" long	EBFUCC-120		\$5260	5804	6171	6551	6940	7341	7755	8181	8619	9071	9537	10017	10509

W 17.5 L 18.5

COM Yardage: 7 yards  
For COL requirements please contact Leland Customer Care.

To specify:  
Please refer to pages 3-4 for complete specifying information.  
Specify all products by their product code.

Pricing Effective: January 2023

EBB FULLY UPHOLSTERED BENCH ONE LINKING END  
 Design: Mark Gabbartas

# EB6



**Ebb Fully Upholstered Bench  
 One Linking End**

	MODEL	LIST PRICE/GRADE	COM/COL	A	B	C	D	E	F	G	H	I	J	K	L
30" long	EBFUCL-30		\$2360	2564	2709	2858	3012	3170	3334	3501	3675	3852	4037	4226	4421

W 17.5 L 18.5

COM Yardage: 1.75 yards  
 For COL requirements please contact Leland Customer Care.  
 Unit comes with skirt.

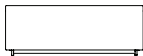

**Ebb Fully Upholstered Bench  
 One Linking End**

	MODEL	LIST PRICE/GRADE	COM/COL	A	B	C	D	E	F	G	H	I	J	K	L
48" long	EBFUCL-48		\$3095	3383	3582	3786	3997	4214	4437	4668	4906	5150	5403	5662	5929

W 17.5 L 18.5

COM Yardage: 2.75 yards  
 For COL requirements please contact Leland Customer Care.  
 Unit comes with skirt.

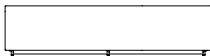

**Ebb Fully Upholstered Bench  
 One Linking End**

	MODEL	LIST PRICE/GRADE	COM/COL	A	B	C	D	E	F	G	H	I	J	K	L
72" long	EBFUCL-72		\$3829	4188	4434	4689	4951	5221	5498	5785	6079	6383	6696	7018	7351

W 17.5 L 18.5

COM Yardage: 4.25 yards  
 For COL requirements please contact Leland Customer Care.  
 Unit comes with skirt.



**Ebb Fully Upholstered Bench  
 One Linking End**

	MODEL	LIST PRICE/GRADE	COM/COL	A	B	C	D	E	F	G	H	I	J	K	L
96" long	EBFUCL-96		\$4564	5017	5326	5644	5973	6311	6659	7017	7387	7766	8159	8561	8977

W 17.5 L 18.5

COM Yardage: 5.5 yards  
 For COL requirements please contact Leland Customer Care.  
 Unit comes with skirt.



**Ebb Fully Upholstered Bench  
 One Linking End**

	MODEL	LIST PRICE/GRADE	COM/COL	A	B	C	D	E	F	G	H	I	J	K	L
120" long	EBFUCL-120		\$5300	5843	6210	6587	6975	7374	7787	8210	8648	9098	9562	10039	10530

W 17.5 L 18.5

COM Yardage: 7 yards  
 For COL requirements please contact Leland Customer Care.  
 Unit comes with skirt.

To specify:  
 Please refer to pages 3-4 for  
 complete specifying information.  
 Specify all products by their  
 product code.



EBB FULLY UPHOLSTERED BENCH TWO LINKING ENDS  
 Design: Mark Gabbartas

EB7



**Ebb Fully Upholstered Bench  
 Two Linking Ends**

	MODEL	LIST PRICE/GRADE	COM/COL	A	B	C	D	E	F	G	H	I	J	K	L
30" long	EBFULL-30		\$2398	2605	2750	2901	3056	3215	3379	3550	3724	3903	4089	4279	4476

W 17.5 L 18.5

COM Yardage: 1.75 yards  
 For COL requirements please contact Leland Customer Care.  
 Unit comes with skirt.

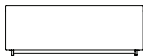

**Ebb Fully Upholstered Bench  
 Two Linking Ends**

	MODEL	LIST PRICE/GRADE	COM/COL	A	B	C	D	E	F	G	H	I	J	K	L
48" long	EBFULL-48		\$3132	3421	3621	3827	4039	4258	4483	4715	4953	5200	5452	5713	5982

W 17.5 L 18.5

COM Yardage: 2.75 yards  
 For COL requirements please contact Leland Customer Care.  
 Unit comes with skirt.

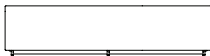

**Ebb Fully Upholstered Bench  
 Two Linking Ends**

	MODEL	LIST PRICE/GRADE	COM/COL	A	B	C	D	E	F	G	H	I	J	K	L
72" long	EBFULL-72		\$3872	4230	4478	4733	4997	5269	5548	5836	6131	6437	6752	7076	7410

W 17.5 L 18.5

COM Yardage: 4.25 yards  
 For COL requirements please contact Leland Customer Care.  
 Unit comes with skirt.



**Ebb Fully Upholstered Bench  
 Two Linking Ends**

	MODEL	LIST PRICE/GRADE	COM/COL	A	B	C	D	E	F	G	H	I	J	K	L
96" long	EBFULL-96		\$4605	5059	5369	5689	6018	6357	6706	7066	7438	7819	8213	8617	9034

W 17.5 L 18.5

COM Yardage: 5.5 yards  
 For COL requirements please contact Leland Customer Care.  
 Unit comes with skirt.

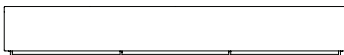

**Ebb Fully Upholstered Bench  
 Two Linking Ends**

	MODEL	LIST PRICE/GRADE	COM/COL	A	B	C	D	E	F	G	H	I	J	K	L
120" long	EBFULL-120		\$5341	5886	6257	6637	7029	7434	7850	8279	8721	9175	9644	10127	10625

W 17.5 L 18.5

COM Yardage: 7 yards  
 For COL requirements please contact Leland Customer Care.  
 Unit comes with skirt.

To specify:  
 Please refer to pages 3-4 for complete specifying information.  
 Specify all products by their product code.

**EBB FULLY UPHOLSTERED BENCH AUXILIARY OPTIONS**

Design: Mark Gabbartas

**EB8**

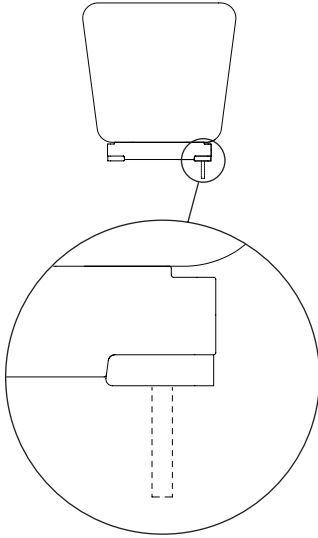

**Ebb Fully Upholstered Bench  
Floor Mount**

MODEL

LIST PRICE

FM

\$257

Due to the variety of floor surfaces on which Ebb products may be installed, floor mount fasteners are not supplied by Leland International. The Ebb product floor mount option consists of feet with floor mount brackets designed to use .5" thread diameter fasteners. Responsibility of fastener choice is the customers.

Floor Mount requires a skirt and both must be specified at the time of ordering. The Floor Mount cannot be added later in the field.



**Ebb Fully Upholstered Bench  
Two Closed Ends Skirt**

MODEL

LIST PRICE

Black Powdercoat Finish

SK

\$161

Ebb Fully Upholstered Bench Two Closed Ends Skirt must be specified at the time of ordering. Skirt cannot be added later in the field. Linking Ebb Benches come standard with skirts..

To specify:

Please refer to pages 3-4 for complete specifying information. Specify all products by their product code.

Pricing Effective: January 2023

## Hub Model

DESCRIPTION	CODE
Ebb Hub, upholstered, one linking end	EBH1L
Ebb Hub, upholstered, two linking ends, 240 degrees	EBH2L
Ebb Hub, upholstered, two linking ends, 180 degrees	EBH3L
Ebb Hub, upholstered, three linking ends	EBH4L

## Upholstery Selection

Please refer to Leland Textile Program which features textiles and leathers from the following partners:

- Camira
- Carnegie
- CF Stinson
- Green Hides
- Maharam
- Unika Vaev

The complete grade list can be found at [www.lelandfurniture.com/resources](http://www.lelandfurniture.com/resources) or you can specify COM/COL. All non pre-approved textiles need to be tested for compatibility.

Due to upholstery requirements, the Ebb product line can only be upholstered railroaded. Please consider when specifying textiles with a pattern. Untested COM or COL textiles will not be accepted.

## Powder Coat Frame Finishes

Ebb Fully Upholstered Hubs have black powder coat skirts.

DESCRIPTION	CODE
Sterling	ST
Warm Grey	WG
Cool Grey	CG
Black	B
White	W
Matte Gold Rush	MGR
Matte Mercury	MMR
Matte Mineral	MMN
Matte Burnish	MBN
Matte Foundry	MFN
Black Textured	BT
Grey Textured	GT
White Textured	WT
Chrome	C

## Auxiliary Options

Auxiliary Options must be specified at the time of the order.

DESCRIPTION	CODE
Ebb Fully Upholstered Hub Floor Mount	FM

## Glides

Ebb glides are nylon.

## Product Specification

Ebb layout is required at the quotation stage and order stage to ensure accurate product specifications. Contact Leland Customer Care for CAD drawings.

## Specifications required to create the product code

- Model
- Model
- Upholstery Selection
- Leg Finish
- Floor Mount (when applicable)



### MODEL

Ebb Fully Upholstered Hub -  
One Linking End (EBH1L)

### UPHOLSTERY SELECTION

Enter upholstery grade,  
COM or COL. Grade J (J)

### LEG FINISH

Specify Standard Powder Coat

### FLOOR MOUNT

When Applicable, enter Ebb  
floor mount code



**EBB FULLY UPHOLSTERED HUB**  
Design: Mark Gabbartas

# EB11

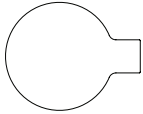

**Ebb Fully Upholstered Hub**

MODEL	LIST PRICE/GRADE	COM/COL	A	B	C	D	E	F	G	H	I	J	K	L
EBH1L		\$7390	8188	8721	9271	9836	10420	11022	11639	12277	12933	13609	14306	15023

One linking end

DIA 60 EXT 15

COM Yardage: 5.25 yards  
For COL requirements please contact Leland Customer Care.  
Unit comes with skirt.

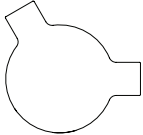

**Ebb Fully Upholstered Hub**

MODEL	LIST PRICE/GRADE	COM/COL	A	B	C	D	E	F	G	H	I	J	K	L
EBH2L		\$7783	8692	9290	9906	10540	11194	11867	12561	13275	14010	14768	15549	16353

Two linking ends, 240 degrees

DIA 60 EXT 15

COM Yardage: 5.75 yards  
For COL requirements please contact Leland Customer Care.  
Unit comes with skirt.

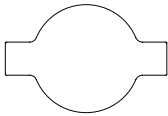

**Ebb Fully Upholstered Hub**

MODEL	LIST PRICE/GRADE	COM/COL	A	B	C	D	E	F	G	H	I	J	K	L
EBH3L		\$7783	8692	9290	9906	10540	11194	11867	12561	13275	14010	14768	15549	16353

Two linking ends, 180 degrees

DIA 60 EXT 15

COM Yardage: 7 yards  
For COL requirements please contact Leland Customer Care.  
Unit comes with skirt.

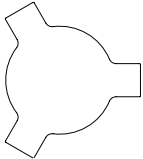

**Ebb Fully Upholstered Hub**

MODEL	LIST PRICE/GRADE	COM/COL	A	B	C	D	E	F	G	H	I	J	K	L
EBH4L		\$8176	9189	9849	10529	11230	11950	12693	13459	14245	15056	15893	16753	17640

Three linking ends

DIA 60 EXT 15

COM Yardage: 8 yards  
For COL requirements please contact Leland Customer Care.  
Unit comes with skirt.

**To specify:**  
Please refer to pages 9-10 for complete specifying information.  
Specify all products by their product code.

**Pricing Effective: January 2023**

# EBB FULLY UPHOLSTERED HUB AUXILIARY OPTIONS

Design: Mark Gabbartas

# EB12

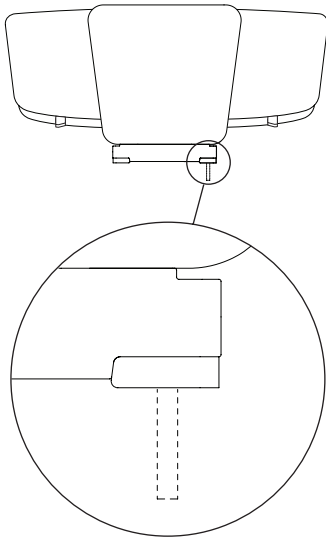

## Ebb Fully Upholstered Hub Floor Mount

MODEL

LIST PRICE

FM

\$257

Due to the variety of floor surfaces on which Ebb products may be installed, floor mount fasteners are not supplied by Leland International. The Ebb product floor mount option consists of feet with floor mount brackets designed to use .5" thread diameter fasteners. Responsibility of fastener choice is the customers.

Floor Mount must be specified at the time of ordering.

The Floor Mount cannot be added later in the field.

To specify:

Please refer to pages 9-10 for complete specifying information.

Specify all products by their product code.

Pricing Effective: January 2023

## Pod Model

DESCRIPTION	CODE
Ebb Fully Upholstered Pod	EBH5

## Upholstery Selection

Please refer to Leland Textile Program which features textiles and leathers from the following partners:

- Camira
- Green Hides
- Carnegie
- Maharam
- CF Stinson
- Unika Vaev

The complete grade list can be found at [www.lelandfurniture.com/resources](http://www.lelandfurniture.com/resources) or you can specify COM/COL.

Due to upholstery requirements, the Ebb product line can only be upholstered railroaded. Please consider when specifying textiles with a pattern. Untested COM or COL textiles will not be accepted.

## Leg Finish

DESCRIPTION	CODE
Sterling	ST
Warm Grey	WG
Cool Grey	CG
Black	B
White	W
Matte Gold Rush	MGR
Matte Mercury	MMR
Matte Mineral	MMN
Matte Burnish	MBN
Matte Foundry	MFN
Black Textured	BT
Grey Textured	GT
White Textured	WT
Chrome	C

## Auxiliary Options

Auxiliary Options must be specified at the time of the order.

### SKIRT:

DESCRIPTION	CODE
Ebb Fully Upholstered Pod Skirt	SK

### FLOOR MAT:

DESCRIPTION	CODE
Ebb Fully Upholstered Pod Floor Mount	FM
Floor Mount requires Skirt.	

## Glides

Ebb glides are nylon.

## Product Specification

Ebb layout is required at the quotation stage and order stage to ensure accurate product specifications. Contact Leland Customer Experience for CAD drawings.

## Specifications required to create the product code

- Model
- Upholstery Selection
- Leg Finish
- Skirt (when applicable)
- Floor Mount (when applicable)



### MODEL

Ebb Fully Upholstered Pod (EBH5)

### UPHOLSTERY SELECTION

Enter upholstery grade, COM or COL. Grade J (J)

### LEG FINISH

Specify Standard Powder Coat

### SKIRT

Skirt (SK)

### FLOOR MOUNT

When applicable, enter Ebb floor mount code. Floor Mount requires Skirt.





EBB FULLY UPHOLSTERED POD  
Design: Mark Gabbartas

# EB15

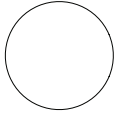

<b>Ebb Fully Upholstered Pod</b>	<b>MODEL</b>	<b>LIST PRICE/GRADE</b>	<b>COM/COL</b>	<b>A</b>	<b>B</b>	<b>C</b>	<b>D</b>	<b>E</b>	<b>F</b>	<b>G</b>	<b>H</b>	<b>I</b>	<b>J</b>	<b>K</b>	<b>L</b>
No linking end	EBH5		\$6834	7616	8135	8667	9217	9782	10365	10966	11584	12222	12877	13553	14248

DIA 54 SH 18.5

COM Yardage: 6 yards  
For COL requirements please contact Leland Customer Care.

To specify:  
Please refer to pages 13-14 for  
complete specifying information.  
Specify all products by their  
product code.

Pricing Effective: January 2023

**EBB FULLY UPHOLSTERED POD AUXILIARY OPTIONS**

Design: Mark Gabbartas

# EB16

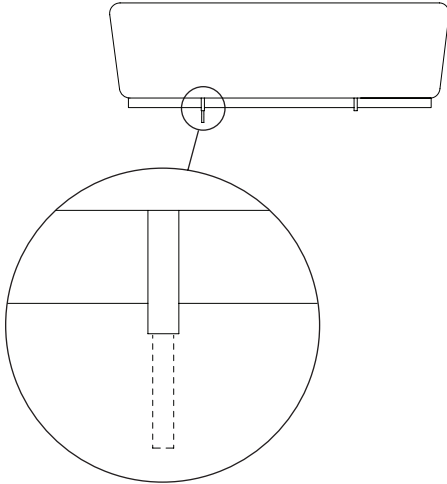

**Ebb Fully Upholstered Pod  
Floor Mount**

	MODEL	LIST PRICE
	FM	\$257

Due to the variety of floor surfaces on which Ebb products may be installed, floor mount fasteners are not supplied by Leland International. The Ebb product floor mount option consists of feet with floor mount brackets designed to use .5" thread diameter fasteners. Responsibility of fastener choice is the customers.

Floor Mount requires a skirt and both must be specified at the time of ordering. The Floor Mount cannot be added later in the field.



**Ebb Fully Upholstered Pod  
Skirt**

	MODEL	LIST PRICE
Black Powdercoat Finish	SK	\$161

Ebb Fully Upholstered Bench Two Closed Ends Skirt must be specified at the time of ordering. Skirt cannot be added later in the field.

**To specify:**  
Please refer to pages 13-14 for complete specifying information. Specify all products by their product code.

**Pricing Effective: January 2023**

---

**5695 Eagle Drive, SE**  
**Grand Rapids,**  
**Michigan 49512**  
**616-975-9260**  
**[lelandfurniture.com](http://lelandfurniture.com)**













# Fast Table

## January 2023 Price List



# Fast Table

Table of Contents	FT2
Visual Reference	FT3
Table Top Specification Information	FT4
Table Top Specification Example	FT5
Table Tops	FT6
Table Base Specification Information	FT7
Table Base Specification Example	FT8
Table Bases	FT9
Modesty Panel Specification Information	FT10
Modesty Panel Specification Example	FT11
Modesty Panel	FT12
Transport Trolley Specification Information	FT13
Transport Trolley Specification Example	FT14
Transport Trolley	FT15

TABLE MODEL	TABLE TOP SIZES			BASE	PAGE
Size A	Round	Sqaure	Rectangle	Powdercoat	Top: Page 6 Base: Page 9
	 48 DIA 54 DIA	 42 x 42	 24 x 48 30 x 48		
Size B	Round	Sqaure	Rectangle	Powdercoat	Top: Page 6 Base: Page 9
	 60 DIA	 48 x 48	 24 x 60 30 x 60		
Size C	Round	Sqaure	Rectangle	Powdercoat	Top: Page 6 Base: Page 9
	 72 DIA	 54 x 54	 24 x 72 30 x 72		

To specify:  
Please refer to pages 3-4 for complete specifying information.  
Specify all products by their product code.

Due to the design intent of Fast, table tops and table bases are sold separately. This page is for specifying the table top only.

**Table Top Model**

ROUND	FITS BASE	CODE
48 DIA	A	F48A
54 DIA	A	F54A
60 DIA	B	F60B
72 DIA	C	F72C
<b>SQUARE</b>		
42x42	A	F4242A
48x48	B	F4848B
54x54	C	F5454C
<b>RECTANGLE</b>		
24x48	A	F2448A
30x48	A	F3048A
24x60	B	F2460B
30x60	B	F3060B
24x72	C	F2472C
30x72	C	F3072C

**Top Surface**

**LAMINATE TOPS:**

DESCRIPTION	CODE
Identify manufacturer, laminate code, & color	L

Please refer to the Leland Terms and Conditions Guide for a listing of standard laminates. For table pricing in laminates not listed, please contact Leland's Customer Experience Department for a quotation.

**Edge Type**

**V7 VINYL EDGE:**

.75" 3mm PVC



**Edge Color**

**V7 VINYL EDGE COLORS:**

DESCRIPTION	CODE
Black	B
Grey	G
Pewter	PW
Saddle	SL
Stone	SN
Truffle	TF
White	W

**Attachment Color**

DESCRIPTION	CODE
Black	B

**Auxiliary Options**

DESCRIPTION	CODE
Ganging Device (two per set)	GD

**Product Weights**

BASES	LBS
FBA	15
FBB	20
FBC	25

ROUND	FITS BASE	LBS
48 DIA	A	50
54 DIA	A	60
60 DIA	B	65
72 DIA	C	75

SQUARE	LBS
42x42	50
48x48	60
54x54	70

RECTANGLE	LBS
24x48	30
30x48	40
24x60	35
30x60	45
24x72	45
30x72	55

Specifications required to create the product code

- Model
- Top Surface
- Edge Color
- Attachment Color
- Auxiliary Options (when applicable)



MODEL

Fast 30 x 60 Rectangle Table Top (F3060B)

TOP SURFACE

Laminate (L)

EDGE COLOR

Grey (G)

ATTACHMENT COLOR

Black (B)

AUXILIARY OPTIONS

When applicable

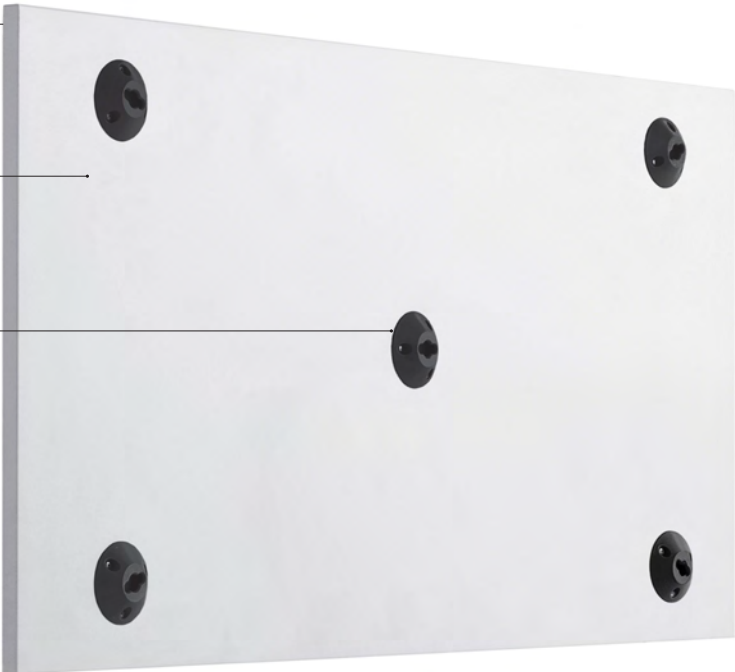





Due to the design intent of Fast, table tops and table bases are sold separately. This page is for specifying the table bases only.

### Table Base Model

---

DESCRIPTION	CODE
Base A (fits 48 Dia, 54 Dia, 42x42, 24x48 and 30x48)	FBA
Base B (fits 60 Dia, 48x48, 24x60 and 30x60)	FBB
Base C (fits 72 Dia, 54x54, 24x72 and 30x72)	FBC

### Base Finish

---

DESCRIPTION	CODE
Sterling	ST
Dolphin Textured	DLT
Oxford Textured	OXT
Grey Textured	GT
Black Textured	BT
White Textured	WT
Matte Mercury	MMR
Matte Mineral	MMN
Matte Burnish	MBN
Matte Foundry	MFN

### Glide and Attachment Color

---

DESCRIPTION	CODE
Black	B

### Freight Note

---

Due to the size and nature of Fast Tables, the Freight Program does not apply to this product. Please contact Customer Experience for a quote.

**Specifications required to create the product code**

- Model
- Base Finish
- Glide and Attachment Color

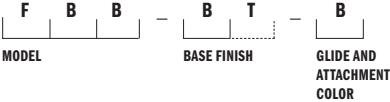

**MODEL**

Fast Size B Table Base (FBB)

**BASE FINISH**

Black Textured (BT)

**GLIDE AND ATTACHMENT COLOR**

Black (B)



# FAST TABLE BASES

Design: Carlos Tíscar, licensed by Sellex

# FT9



Base Size A	MODEL	LIST PRICE
W 46.7 H 27.4	FBA	\$1301

Fits Top Sizes:



Round  
48 DIA  
54 DIA



Square  
42 x 42



Rectangle  
24 x 48  
30 x 48

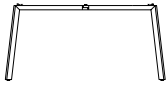

Base Size B	MODEL	LIST PRICE
W 57.8 H 27.4	FBB	\$1327

Fits Top Sizes:



Round  
60 DIA



Square  
48 x 48



Rectangle  
24 x 60  
30 x 60

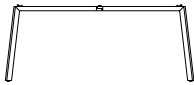

Base Size C	MODEL	LIST PRICE
W 68 H 27.4	FBC	\$1355

Fits Top Sizes:



Round  
72 DIA



Square  
54 x 54



Rectangle  
24 x 72  
30 x 72

**To specify:**

**Please refer to table bases on pages 4-5 and table tops on pages 7-8 for complete specifying information.**

**Specify all products by their product code.**

**Model**

---

DESCRIPTION	FITS BASE	CODE
Modesty panel for 24x48 table	A	FM2448
Modesty panel for 30x48 table	A	FM3048
Modesty panel for 24x60 table	B	FM2460
Modesty panel for 30x60 table	B	FM3060
Modesty panel for 24x72 table	C	FM2472
Modesty panel for 30x72 table	C	FM3072

**Modesty Panel Cover**

---

DESCRIPTION	CODE
Grey	G

**Optional Modesty Panel Cover (Orders of 20+ Units)**

---

DESCRIPTION	CODE
Black	B
White	W

**Specifications required to create the product code**

- Model
- Modesty Panel Color

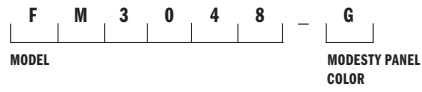

**MODEL**

Fast Modesty Panel for 30 x 48  
Table (FM3048)

**MODESTY PANEL COVER**

Grey (G)



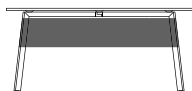

Modesty Panel	MODEL	SIZE	LIST PRICE
		Base A	
	FM2448	24x48	\$285
	FM3048	30x48	\$285
		Base B	
	FM2460	24x60	\$299
	FM3060	30x60	\$299
		Base C	
	FM2472	24x72	\$316
	FM3072	30x72	\$316

**To specify:**

Please refer to table bases on pages 4-5, table tops on pages 7-8 and modesty panels on pages 10-11 for complete specifying information. Specify all products by their product code.

**Model**

---

DESCRIPTION	CODE
Fast Transport Trolley	FTT



**Specifications required to create the product code**

Model



**MODEL**

Fast Transport Trolley (FTT)



**FAST TRANSPORT TROLLEY**  
 Design: Carlos Tíscar, licensed by Sellex

# FT15



Fast Transport Trolley	MODEL	LIST PRICE
Black powder coat finish	FTT	\$2357
W 38.75 D 29.5 H 37.5		

The Fast Transport Trolley can hold up to 6 table bases and 6 table tops.



Fast Transport Trolley	MODEL	LIST PRICE
Black powder coat finish	FTT-72	\$2593
W 38.75 D 29.5 H 37.5		

The Fast Transport Trolley can hold up to (6) C table bases and (4) 72 DIA table tops.

**To specify:**  
 Please refer to page 13-14 for complete  
 specifying information. Specify all products by  
 their product code.

---

**5695 Eagle Drive, SE  
Grand Rapids,  
Michigan 49512  
616-975-9260  
lelandfurniture.com**

# Fixed Table

## January 2023 Price List



# Fixed Table

Table of Contents	FXT2
Visual Reference	FXT3
Specification Information	FXT4
Specification Example	FXT5
Power Planning	FXT6
Round Table	FXT7
Square Table	FXT8
Rectangular Table	FXT9
Counter Height Rectangular Tables	FXT11
Rectangular Bar Height Table	FXT13
Auxiliary Options	FXT15

TABLE MODEL	TABLE TOP SIZES	OPTIONAL POWER	PAGE
Round table	Round  42 DIA 48 DIA 54 DIA 60 DIA	1 Simplex Dual USB	6

TABLE MODEL	TABLE TOP SIZES	OPTIONAL POWER	PAGE
Square table	Square  42 x 42 48 x 48 54 x 54 60 x 60	1 Simplex Dual USB	7

TABLE MODEL	TABLE TOP SIZES	OPTIONAL POWER	PAGE
Rectangular table	Rectangle  30 x 60    36 x 72    42 x 84 30 x 72    36 x 84    42 x 96 30 x 84    36 x 96    42 x 120 36 x 120	2 Simplex units, 1 Dual USB 1 Simplex Dual USB	8



TABLE MODEL	TABLE TOP SIZES	OPTIONAL POWER	PAGE
Rectangular table Counter height	Rectangle  30 x 60    36 x 72    42 x 84 30 x 72    36 x 84    42 x 96 30 x 84    36 x 96    42 x 120 36 x 120	2 Simplex units, 1 Dual USB 1 Simplex Dual USB	9

TABLE MODEL	TABLE TOP SIZES	OPTIONAL POWER	PAGE
Rectangular table Bar height	Rectangle  30 x 60    36 x 72    42 x 84 30 x 72    36 x 84    42 x 96 30 x 84    36 x 96    42 x 120 36 x 120	2 Simplex units, 1 Dual USB 1 Simplex Dual USB	9

## Table Model

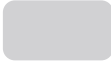
DESCRIPTION	CODE
Fixed Table	FXT

## Top Selection

ROUND		SQUARE	
DESCRIPTION	CODE	DESCRIPTION	CODE
42D	42D-29	42x42	4242-29
48D	48D-29	48x48	4848-29
54D	54D-29	54x54	5454-29
60D	60D-29	60x60	6060-29

RECTANGULAR		COUNTER HEIGHT RECTANGULAR	
DESCRIPTION	CODE	DESCRIPTION	CODE
30x60	3060-29	30x60	3060-36
30x72	3072-29	30x72	3072-36
30x84	3084-29	30x84	3084-36
36x72	3672-29	36x72	3672-36
36x84	3684-29	36x84	3684-36
36x96	3696-29	36x96	3696-36
36x120	36120-29	36x120	36120-36
42x84	4284-29	42x84	4284-36
42x96	4296-29	42x96	4296-36
42x120	42120-29	42x120	42120-36

BAR HEIGHT RECTANGULAR	
DESCRIPTION	CODE
30x60	3060-42
30x72	3072-42
30x84	3084-42
36x72	3672-42
36x84	3684-42
36x96	3696-42
36x120	36120-42
42x84	4284-42
42x96	4296-42
42x120	42120-42

## Top and Edge Finish

### HPL (HIGH PRESSURE LAMINATE)

DESCRIPTION	CODE
Platinum Wilsonart® (D315-60)	LGP
Black Pionite® (SE101)	LBK
White Wilsonart® (D354-60)	LWH

Edge finish options: Matching ABS (V5), natural (11) plywood (W2)  
 Please refer to the Leland Terms and Conditions Guide for a listing of standard laminates.  
 For table pricing in laminates not listed, please contact Leland's Customer Experience Department for a quotation.

### FORBO

DESCRIPTION	CODE
Pearl	4157
Mauve	4172
Pebble	4175
Smokey Blue	4179
Olive	4184

Edge finish options: natural (11) plywood (W2)

**Pricing Effective: January 2023**

## Top and Edge Finish (cont.)

### CORIAN



DESCRIPTION	CODE
Silverite	CG
Nocturne	CB
Cameo White	CW
Domino Terrazzo	CDT

Edge finish options: S1 Edge (CG,CB, & CW) and S2 Edge (CDT,CBT, & CPT)

## Leg Finish

DESCRIPTION	CODE
White Textured Powder coat	WT
Black Textured Powder coat	BT
Grey Textured Powder coat	GT

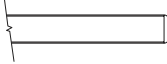
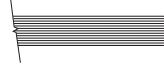
## Edge Type

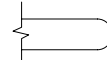
DESCRIPTION	CODE	DESCRIPTION	CODE
3/4" flat PVC	V5	1" flat plywood	W2
			
1" square (Solid Color Corian Tops)	S1	1" bullnose (Terrazzo Corian Tops)	S2
			

## Glide Type

DESCRIPTION
Standard (Black nylon adjustable leveling)

## Power Options

DESCRIPTION	CODE
Single Simplex Unit (centered)	PWR
Dual USB Unit (centered)	USB
Power Kit	KIT

\*(2) Single Simplex & (1) Dual USB (only available on rectangular tables)

## Auxiliary Options

DESCRIPTION	CODE
Storage Caddy	SC

\*only available on rectangular tables

**Specifications required to create the product code**

- Model
- Top Selection
- Top Finish
- Leg Finish
- Edge Type
- Power (if applicable)
- Auxiliary Option (if applicable)
- Glide Type



**MODEL**

Fixed Table (FXT)

**TOP SELECTION**

Counter Height Rectangular  
(3060-36)

**TOP FINISH**

Black Laminate (LBK)

**LEG FINISH**

Black Textured Powder coat (BT)

**EDGE TYPE**

1" flat plywood (W2)

**POWER**

When applicable enter power option (see page FXT6 for options)

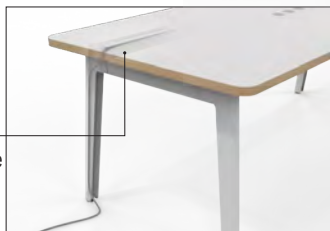

**AUXILIARY OPTION**

Storage Caddy (SC)

**GLIDE**

Standard (S)





## Options

- Single Simplex Unit (centered, includes 120" plug-in infeed) (PWR)
- Dual USB Unit (centered) (USB)
- Power Kit (KIT)
- \*(2) Single Simplex & (1) Dual USB (only available on rectangular tables, centered)



Single Simplex Unit



Dual USB



Wire Management

## Power Kit (-KIT)

- \*(2) Single Simplex & (1) Dual USB (only available on rectangular tables, centered)



**FIXED TABLE ROUND**  
 Design: 2B Studio, Justin Burton

# FXT7



**Fixed Table Round**

	MODEL	TOP SIZE/CODE	LIST PRICE/EDGE CODES:	V5	W2
Powder coat base	FXT-	Laminate Top			
H 29		42D		\$2225	2560
		48D		\$2284	2695
		54D		\$2343	2812
		60D		\$2410	2940
Round					
42 DIA					
48 DIA		Forbo Top			W2
54 DIA		42D			\$2672
60 DIA		48D			\$2742
		54D			\$2813
		60D			\$2899
		Corian Top	S1		
		42D	\$5548		
		48D	\$5746		
		54D	\$5933		
		60D	\$6106		
		Terrazzo Corian Top	S2		
		42D	\$9190		
		48D	\$10679		
		54D	\$11645		
		60D	\$12603		

**To specify:**  
 Please refer to pages 3-4 for complete specifying information.  
 Specify all products by their product code.

**Pricing Effective: January 2023**

**FIXED TABLE SQUARE**  
 Design: 2B Studio, Justin Burton

**FXT8**

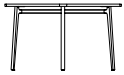

<b>Fixed Table Square</b>	<b>MODEL</b>	<b>TOP SIZE/CODE</b>	<b>LIST PRICE/EDGE CODES:</b>	<b>V5</b>	<b>W2</b>
Powder coat base	FXT-	Laminate Top			
H 29		42x42		\$2225	2560
		48x48		\$2284	2695
		54x54		\$2343	2812
	Square	60x60		\$2410	2940
42x42					
48x48		Forbo Top			<b>W2</b>
54x54		42x42			\$2672
60x60		48x48			\$2742
		54x54			\$2813
		60x60			\$2899
		Corian Top	<b>S1</b>		
		42x42	\$5548		
		48x48	\$2224		
		54x54	\$5933		
		60x60	\$6106		
		Terrazzo Corian Top	<b>S2</b>		
		42x42	\$9190		
		48x48	\$10679		
		54x54	\$11645		
		60x60	\$12603		

**To specify:**  
 Please refer to pages 3-4 for complete specifying information.  
 Specify all products by their product code.

**Pricing Effective: January 2023**

**FIXED TABLE RECTANGULAR**  
 Design: 2B Studio, Justin Burton

# FXT9



<b>Fixed Table Rectangular</b>	<b>MODEL</b>	<b>TOP SIZE/CODE</b>	<b>LIST PRICE/EDGE CODES:</b>	<b>V5</b>	<b>W2</b>
Powder coat base	FXT-	Laminate Top			
H 29		30x60		\$2343	2694
		30x72		\$2525	2904
		30x84		\$2695	3180
	Rectangle	36x72		\$2889	3409
30x60		36x84		\$3165	3797
30x72		36x96		\$3352	4088
30x84		36x120		\$3814	4766
36x84		42x84		\$3486	4320
36x96		42x96		\$3621	4490
36x120		42x120		\$3892	4831
42x84					
42x96		Forbo Top			<b>W2</b>
42x120		30x60			\$2881
		30x72			\$3106
		30x84			\$3318
		36x72			\$3553
		36x84			\$3863
		36x96			\$4089
		36x120			\$4624
		42x84			\$4265
		42x96			\$4435
		42x120			\$4776

**To specify:**  
 Please refer to pages 3-4 for complete specifying information.  
 Specify all products by their product code.

**Pricing Effective: January 2023**

FIXED TABLE RECTANGULAR cont.  
 Design: 2B Studio, Justin Burton

# FXT10



**Fixed Table Rectangular**

	MODEL	TOP SIZE/CODE	LIST PRICE/EDGE CODES:
Powder coat base	FXT-	Corian Top	<b>S1</b>
H 29		30x60	\$5693
		30x72	\$5851
		30x84	\$6045
		36x72	\$6217
		36x84	\$6384
		36x96	\$6523
		36x120	\$6829
		42x84	\$6687
		42x96	\$6811
		42x120	\$7058
		Terrazzo Corian Top	<b>S2</b>
		30x60	\$7216
		30x72	\$7768
		30x84	\$8283
		36x72	\$10647
		36x84	\$11650
		36x96	\$12327
		36x120	\$14008
		42x84	\$12832
		42x96	\$13469
		42x120	\$14746

To specify:  
 Please refer to pages 3-4 for complete specifying information.  
 Specify all products by their product code.

Pricing Effective: January 2023

**FIXED TABLE COUNTER HEIGHT RECTANGULAR**  
 Design: 2B Studio, Justin Burton

**FXT11**

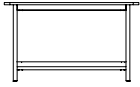

**Fixed Table Counter Height  
 Rectangular**

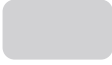
	MODEL	TOP SIZE/CODE	LIST PRICE/EDGE CODES:	V5	W2
Powder coat base	FXT-	Laminate Top			
H 36		30x60		\$3564	4099
		30x72		\$3699	4253
		30x84		\$3834	4523
	Rectangle	36x72		\$3951	4662
30x60		36x84		\$4069	4883
30x84		36x96		\$4175	5009
36x72		36x120		\$4398	5357
36x84		42x84		\$4327	5278
36x96		42x96		\$4386	5348
36x120		42x120		\$4503	5490
42x84					
42x96		Forbo Top			<b>W2</b>
42x120		30x60			\$3709
		30x72			\$3848
		30x84			\$3988
		36x72			\$4110
		36x84			\$4233
		36x96			\$4343
		36x120			\$4575
		42x84			\$4501
		42x96			\$4549
		42x120			\$4645

**To specify:**  
 Please refer to pages 3-4 for complete specifying information.  
 Specify all products by their product code.

**Pricing Effective: January 2023**

FIXED TABLE COUNTER HEIGHT RECTANGULAR cont.  
 Design: 2B Studio, Justin Burton

**FXT12**



**Fixed Table Counter Height  
 Rectangular**

	MODEL	TOP SIZE/CODE	LIST PRICE/EDGE CODES:
Powder coat base	FXT-	Corian Top	<b>S1</b>
H 36		30x60	\$6566
		30x72	\$6665
		30x84	\$6796
		36x72	\$6921
		36x84	\$7040
		36x96	\$7194
		36x120	\$7466
		42x84	\$7310
		42x96	\$7492
		42x120	\$7856
		Terrazzo Corian Top	<b>S2</b>
		30x60	\$9749
		30x72	\$10113
		30x84	\$10479
		36x72	\$12956
		36x84	\$13478
		36x96	\$13679
		36x120	\$14404
		42x84	\$14213
		42x96	\$14365
		42x120	\$14674

To specify:  
 Please refer to pages 3-4 for  
 complete specifying information.  
 Specify all products by their  
 product code.

Pricing Effective: January 2023

**FIXED TABLE BAR HEIGHT RECTANGULAR**  
 Design: 2B Studio, Justin Burton

**FXT13**

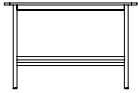

**Fixed Table Bar Height  
 Rectangular**

	MODEL	TOP SIZE/CODE	LIST PRICE/EDGE CODES:	V5	W2
Powder coat base	FXT-	Laminate Top			
H 42		30x60		\$3594	4133
		30x72		\$3728	4287
		30x84		\$3863	4558
	Rectangle	36x72		\$3981	4696
30x60		36x84		\$4099	4918
30x72		36x96		\$4204	5045
36x72		36x120		\$4426	5393
36x84		42x84		\$4356	5315
36x96		42x96		\$4415	5387
36x120		42x120		\$4533	5530
42x84					
42x96		Forbo Top			<b>W2</b>
42x120		30x60			\$3739
		30x72			\$3878
		30x84			\$4017
		36x72			\$4139
		36x84			\$4263
		36x96			\$4360
		36x120			\$4580
		42x84			\$4530
		42x96			\$4578
		42x120			\$4675

**To specify:**  
 Please refer to pages 3-4 for complete specifying information.  
 Specify all products by their product code.

**Pricing Effective: January 2023**



**FIXED TABLE BAR HEIGHT RECTANGULAR cont.**  
 Design: 2B Studio, Justin Burton

**FXT14**

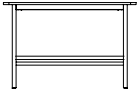

**Fixed Table Bar Height  
 Rectangular**

	MODEL	TOP SIZE/CODE	LIST PRICE/EDGE CODES:
Powder coat base	FXT-	Corian Top	<b>S1</b>
H 42		30x60	\$6658
		30x72	\$6769
		30x84	\$6815
		36x72	\$6942
		36x84	\$7064
		36x96	\$7196
		36x120	\$7449
		42x84	\$7337
		42x96	\$7515
		42x120	\$7873
		Terrazzo Corian Top	<b>S2</b>
		30x60	\$9711
		30x72	\$10076
		30x84	\$10440
		36x72	\$12910
		36x84	\$13291
		36x96	\$13634
		36x120	\$14359
		42x84	\$14129
		42x96	\$14534
		42x120	\$15347

**To specify:**  
 Please refer to pages 3-4 for complete specifying information.  
 Specify all products by their product code.

**Pricing Effective: January 2023**

Single Simplex Unit	MODEL	LIST PRICE
	PWR	\$140

Dual USB Unit	MODEL	LIST PRICE
	USB	\$250

Power Kit	MODEL	LIST PRICE
	KIT	\$1548

Fixed Table Storage Caddy	MODEL	LIST PRICE
	SC	\$454

To specify:  
Please refer to pages 3-4 for  
complete specifying information.  
Specify all products by their  
product code.

---

**5695 Eagle Drive, SE  
Grand Rapids,  
Michigan 49512  
616-975-9260  
lelandfurniture.com**

# Fly Table

## January 2023 Price List



# Fly Table

Table of Contents	FLY2
Specification Information	FLY3
Specification Example	FLY4
Textured Paint	FLY5
HPL	FLY5
Wood Veneer	FLY6

## Table Model

DESCRIPTION	CODE
Fly Table	FLY

## Top Collection

### RECTANGLE

DESCRIPTION	CODE	DESCRIPTION	CODE
30x60	3060	30D	30D
36x72	3672	36D	36D
42x84	4284	42D	42D
		48D	48D

### ROUND

DESCRIPTION	CODE
30D	30D
36D	36D
42D	42D
48D	48D

### LEFT HAND 'L'

DESCRIPTION	CODE	DESCRIPTION	CODE
40x55	4055L	30x60	30600
46x63	4663L	36x72	36720
52x72	5272L	42x84	42840
		48x96	48960

### OVAL

DESCRIPTION	CODE
30x60	30600
36x72	36720
42x84	42840
48x96	48960

### RIGHT HAND 'R'

DESCRIPTION	CODE
40x55	4055R
46x63	4663R
52x72	5272R

### VISUAL REFERENCE:



Left and right hand designations are as seated.

## Top and Edge Finish

### WOOD VENEER TEXTURED PAINT

DESCRIPTION	CODE	DESCRIPTION	CODE
Rift Cut Oak	O	White	WT
Walnut	W	Black	BT
		Grey	GT

Edge finish options:

Natural	11	Edge finish painted to match
Oak stain match	O	
Walnut stain match	W	

### HPL (HIGH PRESSURE LAMINATE)

DESCRIPTION	CODE
Grey	Platinum Wilsonart® (D315-60)
Black	Black Pionite® (SE101)
White Designer	White Wilsonart® (D354-60)

Edge Finish Natural (11) Plywood only

## Leg Selection

DESCRIPTION	CODE
Powder coat Legs	P
Polished Aluminum Legs	PA

## Leg Finish (when applicable)

DESCRIPTION	CODE
White Textured Powder coat	WT
Black Textured Powder coat	BT
Grey Textured Powder coat	GT

\*Please Note: Leg finish specification is required ONLY for Powder coat (P) legs

## Edge Type

### STANDARD EDGE:

reverse back bevel

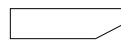

## Glide Type

DESCRIPTION	CODE
Black Rubber Glide	S

## Auxiliary Options

DESCRIPTION	CODE	DESCRIPTION	CODE
Power Flip Top Grommet	PT	Front Divider Screen	FD
Cable Duct	CD	Side Divider Screen	SD
Textile Cable Tray	CT	Courtesy Screen	CS
Ganging	G		

Auxiliary options are priced upon request. Please contact Customer Experience (800) 859-7510 for pricing.

## Specifications required to create the product code

---

- Table Model
- Top Selection
- Top Finish
- Leg Selection
- Leg Finish
- Glide Selection

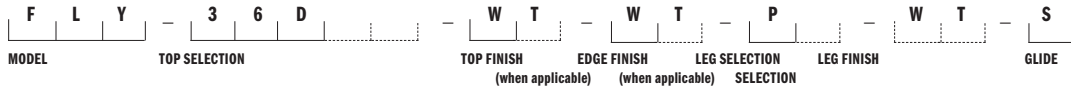

---

### MODEL

Fly Table (FLY)

### TOP SELECTION

36 Diameter Round (36D)

### TOP FINISH

White Textured Paint (WT)

### EDGE FINISH

White Textured Paint (WT)

### LEG SELECTION

Powder coat (P)

### LEG FINISH

White Textured Paint (WT)

### GLIDE SELECTION

Standard Glide (S)







# FLY TABLE





Design: Lievore Altherr Molina, licensed by Sellex

# FLY5

## Textured Paint Top

			TOP SHAPE	TOP SIZE	POWDERCOAT LEGS	POLISHED ALUMINUM LEGS
H 29.5	Top Shape		Rectangle	30x60	\$2038	2169
				36x72	\$2328	2456
				42x84	\$2669	2798
			L - Table	40x55	\$2187	2316
				46x63	\$2440	2569
				52x72	\$2748	2877
			Round	30D	\$1711	1841
				36D	\$1855	1983
				42D	\$2024	2155
				48D	\$2222	2351
			Oval	30x60	\$2112	2242
				36x72	\$2430	2560
				42x84	\$2804	2935
				48x96	\$2974	3104

## HPL Top (High Pressure Laminate)

			TOP SHAPE	TOP SIZE	POWDERCOAT LEGS	POLISHED ALUMINUM LEGS
H 29.5	Top Shape		Rectangle	30x60	\$2110	2240
				36x72	\$2428	2558
				42x84	\$2802	2933
			L - Table	40x55	\$2272	2399
				46x63	\$2552	2680
				52x72	\$2889	3017
			Round	30D	\$1750	1879
				36D	\$1909	2037
				42D	\$2098	2225
				48D	\$2312	2441
			Oval	30x60	\$2191	2320
				36x72	\$2540	2669
				42x84	\$2954	3082
				48x96	\$3139	3269

**To specify:**  
 Please refer to pages 3-4 for complete specifying information.  
 Specify all products by their product code.







# FLY TABLE

Design: Lievore Altherr Molina, licensed by Sellex

# FLY6

## Wood Veneer Top

		TOP SHAPE	TOP SIZE	POWDERCOAT LEGS	POLISHED ALUMINUM LEGS	
H 29.5	Top Shape		Rectangle	30x60	\$2209	2339
				36x72	\$2588	2716
				42x84	\$3035	3165
			L - Table	40x55	\$2399	2529
				46x63	\$2735	2864
				52x72	\$3138	3268
			Round	30D	\$1799	1928
				36D	\$1988	2118
				42D	\$2212	2343
				48D	\$2586	2715
			Oval	30x60	\$2300	2430
				36x72	\$2716	2844
				42x84	\$3208	3339
				48x96	\$3449	3578

**To specify:**

Please refer to pages 3-4 for complete specifying information.

Specify all products by their product code.

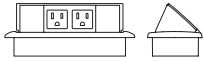

**Power - Flip Top Grommet**

LIST PRICE

2- 110v, 1 USB

\$1130



**Ganging**

LIST PRICE

Link tops frontally or on the side

\$176



**Textile Cable Tray**

LIST PRICE

2- 110v, 1 USB

\$176

**Cable Duct**

LIST PRICE

2- 110v, 1 USB

\$176

To specify:  
Please refer to pages 3-4 for  
complete specifying information.  
Specify all products by their  
product code.



**Front Divider Panel**

LIST PRICE

47.25W

\$939

Divider material is a rigid polyurethane, textured and laquered in your choice of Matte White, Black, or Grey.



**Side Divider Panel**

LIST PRICE

23.5W

\$587

Divider material is a rigid polyurethane, textured and laquered in your choice of Matte White, Black, or Grey.

To specify:  
Please refer to pages 3-4 for complete specifying information.  
Specify all products by their product code.

---

**5695 Eagle Drive, SE  
Grand Rapids,  
Michigan 49512  
616-975-9260  
lelandfurniture.com**

# Gemma Occasional Table

January 2023 Price List



# Gemma Occasional Table

Table of Contents	GT2
Visual Reference	GT3
Specification Information	GT4
Specification Example	GT5
Power Planning	GT6
Sled Base	GT7
Wood Base	GT7
Totem Base	GT8
Height Adjustable Base	GT8

TABLE MODEL		TABLE TOP SIZES & BASE HEIGHT	BASE	PAGE
Sled Base (GETS)		32 DIA, 15H	Powder Coat	Page GT7
		32 DIA, 18H		
		20 DIA, 22H		
		20 DIA, 26H		

TABLE MODEL		TABLE TOP SIZES	BASE	PAGE
Wood Base (GETW)		32 DIA, 15H	Birch	Page GT7
		32 DIA, 18H	Walnut	
		20 DIA, 22H	Oak	
		20 DIA, 26H	Painted Wood	

TABLE MODEL		TABLE TOP SIZES	BASE	PAGE
Totem Base (GETT)		32 DIA, 15H	Powder Coat	Page GT8
		32 DIA, 18H		
		20 DIA, 22H		
		20 DIA, 26H		

TABLE MODEL		TABLE TOP SIZES	BASE	PAGE
Height Adjustable (GETH)		32 DIA, 23-29H	Powder Coat	Page GT8

**Model**

DESCRIPTION	CODE
Gemma occasional table, sled base	GETS
Gemma occasional table, wood base	GETW
Gemma occasional table, totem base	GETT
Gemma occasional table, height adjustable base	GETH

**Top Size & Base Height**

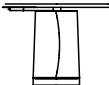
**SLED BASE:**

DESCRIPTION	CODE
32D, 15H	3215
32D, 18H	3218
20D, 22H	2022
20D, 26H	2026

**WOOD BASE:**

DESCRIPTION	CODE
32D, 15H	3215
32D, 18H	3218
20D, 22H	2022
20D, 26H	2026

**TOTEM BASE:**

DESCRIPTION	CODE
32D, 15H	3215
32D, 18H	3218
20D, 22H	2022
20D, 26H	2026

**HEIGHT ADJUSTABLE BASE:**

DESCRIPTION	CODE
32D, 23-29H	3229

**Top Type**

**WOOD**

DESCRIPTION	CODE
Birch	B
Oak	O
Walnut	W
Painted Wood	P

**Top & Wood Base Finishes**

\*Wood bases default to specified top type except Painted Tops which pair with oak bases.

**BIRCH FINISH OPTIONS**

DESCRIPTION	CODE
Natural	11
Graphite	25
Transparent Black	29
White Wash II	30
Blue Sky	100M
Forest	101M
Sienna	106M
Willow	108M

**OAK FINISH OPTIONS**

DESCRIPTION	CODE
Natural White Oak	12
Morel	66M

**WALNUT FINISH OPTIONS**

DESCRIPTION	CODE
Natural Walnut	08M

**TEXTURED PAINT (TOPS ONLY)**

DESCRIPTION	CODE
White	WT
Black	BT

**Sled & Totem Base Finishes**

DESCRIPTION	CODE
Black	B
White	W
Black Textured	BT
White Textured	WT
Matte Mercury	MMR
Matte Mineral	MMN
Matte Burnish	MBN
Matte Foundry	MFN
Matte Blue Sky	MBS
Matte Forest	MFO
Matte Willow	MWL
Matte Sienna	MSN
Chrome (Sled Base Only)	C

**Power Option**

DESCRIPTION	CODE
Dual USB Unit	USB

\*Available only on 22H and 26H Totem Base



**Specifications required to create the product code**

- Model
- Top Size
- Top Type
- Top Finish
- Base Height
- Base Finish



**MODEL**

Height Adjustable (GETH)

**TOP SIZE**

32 DIA (32)

**TOP TYPE**

Oak (0)

**TOP FINISH**

Natural White Oak (12)

**BASE HEIGHT**

23-29" (29)

**BASE FINISH**

Matte Willow Powder Coat (MWL)



**Options**

- Dual USB Unit (USB), standard cord

\*Available only on 22H and 26H Totem Base



**Dual USB**



**Gemma Occasional Table,  
Power Options**

	MODEL	LIST PRICE
Available on 22" Height and 26" Height Totem Base	USB Dual USB Unit	\$234

GEMMA OCCASIONAL TABLE  
Design: Altherr Désile Park

GT7



**Gemma Occasional Table,  
Sled Base**

	MODEL		TEXTURED PAINT TOP	BIRCH TOP	OAK TOP	WALNUT TOP
32" DIA, Up Edge 15" Height	GETS-3215	Powder Coat	\$1155	N/A	1370	1485
	GETS-3215	Chrome	\$1335	N/A	1582	1715
32" DIA Top, Up Edge 18" Height	GETS-3218	Powder Coat	\$1210	N/A	1425	1540
	GETS-3218	Chrome	\$1390	N/A	1637	1770
20" DIA Top, Waterfall Edge 22" Height	GETS-2022	Powder Coat	\$737	781	836	886
	GETS-2022	Chrome	\$847	898	960	1018
20" DIA Top, Waterfall Edge 26" Height	GETS-2026	Powder Coat	\$990	1045	1210	1375
	GETS-2026	Chrome	\$1137	1201	1390	1581



**Gemma Occasional Table,  
Wood Base**

	MODEL		TEXTURED PAINT TOP, OAK BASE	BIRCH TOP, BIRCH BASE	OAK TOP, OAK BASE	WALNUT TOP, WALNUT BASE
32" DIA Top, Up Edge 15" Height	GETW-3215	Wood Base	\$1309	N/A	1507	1628
32" DIA Top, Waterfall Edge 18" Height	GETW-3218	Wood Base	\$1254	N/A	1452	1573
20" DIA Top, Waterfall Edge 22" Height	GETW-2022	Wood Base	\$776	820	875	924
20" DIA Top, Waterfall Edge 26" Height	GETW-2026	Wood Base	\$1155	1210	1430	1650

**To specify:**  
Please refer to pages 3-5 for complete specifying information.  
Specify all products by their product code.

**Pricing Effective: January 2023**

GEMMA OCCASIONAL TABLE  
Design: Altherr Désile Park

GT8



**Gemma Occasional Table,  
Totem Base**

	MODEL		TEXTURED PAINT TOP	BIRCH TOP	OAK TOP	WALNUT TOP
32" DIA Top, Up Edge 15" Height	GETT-3215	Powder Coat	\$1311	N/A	1476	1542
32" DIA Top, Up Edge 18" Height	GETT-3218	Powder Coat	\$1430	N/A	1595	1661
20" DIA Top, Waterfall Edge 22" Height	GETT-2022	Powder Coat	\$831	875	1034	1194
20" DIA Top, Waterfall Edge 26" Height	GETT-2026	Powder Coat	\$1485	1540	1678	1815

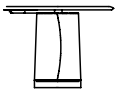

**Gemma Occasional Table,  
Height Adjustable**

	MODEL		TEXTURED PAINT TOP	OAK TOP	WALNUT TOP
32" DIA Top, Waterfall Edge 23" - 29" Height Adjustable	GETH-3229	Powder Coat	\$2783	2948	3014

**To specify:**  
Please refer to pages 3-5 for complete specifying information.  
Specify all products by their product code.

**Pricing Effective: January 2023**

---

**5695 Eagle Drive, SE  
Grand Rapids,  
Michigan 49512  
616-975-9260  
lelandfurniture.com**

# Gemma Stitch

## January 2023 Price List



# Gemma Stitch

Table of Contents	GS2
Specification Information	GS3
Specification Example	GS4
Gemma Stitch	GS5
Gemma Stitch Handle	GS5
Gemma Stitch Return Swivel	GS5

## Chair Model

---

DESCRIPTION	CODE
Gemma Stitch	GEML

## Upholstery Selection

---

Please refer to Leland Textile Program which features textiles and leathers from the following partners:

- Camira
- Green Hides
- Carnegie
- Maharam
- CF Stinson
- Unika Vaev

The complete grade list can be found at Leland's website or you can specify COM/COL. Due to the design of this product, it is recommended that all non pre-approved textile be tested for compatibility.

## Optional

---

DESCRIPTION	CODE
Gemma Stitch Handle	GH
Gemma Stitch Return Swivel	RS

\*Handle not available on return swivel base model

## Product Weight

---

DESCRIPTION	LBS
Gemma Stitch Wood Base	39



**Specifications required to create the product code**

- Model
- Upholstery Selection
- Handle (If Applicable)



**MODEL**

Gemma Stitch (GEML)

**UPHOLSTERY SELECTION**

Enter upholstery grade or COM

**GEMMA STITCH HANDLE**

When applicable, enter GH



GEMMA STITCH  
Design: Altherr Désile Park

GS5

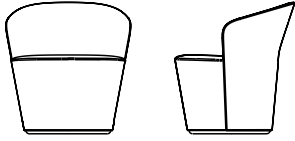

**Gemma Stitch**

W 24.5 D 26 H 30  
SH 18

MODEL	LIST PRICE/ GRADE	COM/COL	A	B	C	D	E	F	G	H	I	J	K	L
GEML		\$2441	2599	2702	2805	2907	3028	3149	3270	3406	3543	3679	3816	3952

COM Yardage: 3.25 Yards  
Contact Leland Customer Experience for yardage requirements on textiles with repeats.  
For COL requirements please contact Leland Customer Experience.

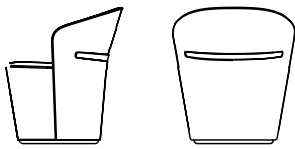

**Gemma Stitch Handle**

MODEL	LIST PRICE
GH	\$47

\*Handle not available on return swivel base model

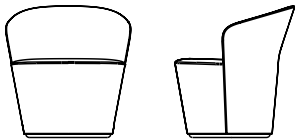

**Gemma Stitch,  
Return Swivel Base**

W 24.5 D 26 H 30  
SH 18

MODEL	LIST PRICE/ GRADE	COM/COL	A	B	C	D	E	F	G	H	I	J	K	L
GEML-RS		\$2563	2729	2837	2945	3052	3179	3306	3434	3576	3720	3863	4007	4150

COM Yardage: 3.25 Yards  
Contact Leland Customer Experience for yardage requirements on textiles with repeats.  
For COL requirements please contact Leland Customer Experience.  
\*Handle not available on return swivel base model

To specify:  
Please refer to pages 3-4 for complete specifying information.  
Specify all products by their product code.

---

**5695 Eagle Drive, SE**  
**Grand Rapids,**  
**Michigan 49512**  
**616-975-9260**  
**[lelandfurniture.com](http://lelandfurniture.com)**

# Gemma Table

## January 2023 Price List



# Gemma Table

Table of Contents	GT2
Visual Reference	GT3
Specification Information	GT4
Specification Example	GT5
Power Planning	GT6
Totem Base	GT7
Wood Base	GT7

TABLE MODEL		TOP SIZES & HEIGHT	BASE	PAGE
Totem Base (GETT)		42 DIA, 29H 48 DIA, 29H	Powder Coat	Page GT7

TABLE MODEL		TOP SIZES & HEIGHT	BASE	PAGE
Wood Base, Round Top (GETD)		42 DIA, 29H 48 DIA, 29H	Beech Walnut Oak	Page GT7



TABLE MODEL		TOP SIZES & HEIGHT	BASE	PAGE
Wood Base, Soft Square Top (GETD)		42x42, 29H 48x48, 29H	Beech Walnut Oak	Page GT7

TABLE MODEL		TOP SIZES & HEIGHT	BASE	PAGE
Wood Base, Soft Rectangle Top (GETD)		60x36, 29H 72x36, 29H 84x42, 29H 96x42, 29H	Beech Walnut Oak	Page GT7

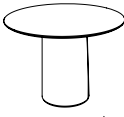
**Model**

DESCRIPTION	CODE
Gemma table, totem base	GETT
Gemma table, wood base	GETD

**Top Size & Base Height**

**TOTEM BASE:**

DESCRIPTION	CODE
42D, 29H	42D
48D, 29H	48D

**WOOD BASE:**

DESCRIPTION	CODE
42x42, 29H	4242
42D, 29H	42D
48x48, 29H	4848
48D, 29H	48D
60x36, 29H	6036
72x36, 29H	7236
84x42, 29H	8442
96x42, 29H	9642

**Top Material**

**WOOD**

DESCRIPTION	CODE
Beech	B
Oak	O
Walnut	W
Forbo	F
Laminate	L

**Top & Wood Base Finishes**

\*Wood bases default to specified top type except Laminate and Forbo which pair with Beech bases, unless otherwise specified.

**BEECH FINISH OPTIONS**

DESCRIPTION	CODE
Natural	11
Graphite	25
Transparent Black	29
White Wash II	30
Blue Sky	100M
Forest	101M
Sienna	106M
Willow	108M

**OAK FINISH OPTIONS**

DESCRIPTION	CODE
Natural White Oak	12
Morel	66M

**WALNUT FINISH OPTIONS**

DESCRIPTION	CODE
Natural Walnut	08M

**FORBO FINISH OPTIONS**

DESCRIPTION	CODE
Smokey Blue	4179
Powder	4185
Pebble	4175
Olive	4184
Mauve	4172

**LAMINATE FINISH OPTIONS**

DESCRIPTION	CODE
Platinum Wilsonart® (D315-60)	LGP
Black Pionite® (SE101)	LBK
White Wilsonart® (D354-60)	LWH

**Totem Base Finishes**

DESCRIPTION	CODE
Black	B
White	W
Black Textured	BT
White Textured	WT
Matte Mercury	MMR
Matte Mineral	MMN
Matte Burnish	MBN
Matte Foundry	MFN
Matte Blue Sky	MBS
Matte Forest	MFO
Matte Willow	MWL
Matte Sienna	MSN

**Power Option**

1 Simplex, 1 USB A+C

DESCRIPTION	CODE
Edge Mounted, White	PEM-W
Edge Mounted, Black	PEM-B
In-Surface, White	PIS-W
In-Surface, Black	PIS-B

\*Totem base models with power must choose from in-surface power options

**Edge Types**

DESCRIPTION	CODE
Wood Edge	W7
Flat PVC Edge	V6

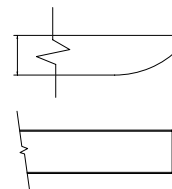

\*W7 edge on Beech, Oak, Walnut, and Forbo tops only.

^V6 edge on Laminate tops only.

**Specifications required to create the product code**

- Model
- Top Size
- Top Type
- Top Finish
- Base Finish
- Power Option (Optional)



**MODEL**

Gemma Table, Wood Base (GETD)

**TOP SIZE**

42 DIA (42D)

**TOP TYPE**

Oak (0)

**TOP FINISH**

Natural White Oak (12)

**BASE HEIGHT**

29 Inches

**BASE FINISH**

Natural White Oak (12)





**Options**

- 1 Simplex, 1 USB A+C, braided cord
- Edge Mounted and In-Surface options available on Wood Base Models
- In-Surface options available on Totem Base Models
- Cord Length: Differs based on table size. All tables will have approximately 2' of additional cord from the base of the leg.

**Edge Mounted Power**



**Wire Management**



**In-Surface Power**

**Gemma Table,  
Power Options**

	MODEL	LIST PRICE
1 Simplex, 1 USB A+C Braided Cord	PEM-W Edge Mounted, White	\$185
	PEM-B Edge Mounted, Black	\$185
	PIS-W In-Surface, White	\$303
	PIS-B In Surface, Black	\$303

\*Edge Mounted Power located 3 inches from edge of table leg

GEMMA TABLE  
Design: Altherr Désile Park

GT7

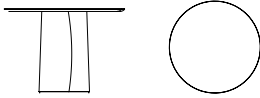

**Gemma Table,  
Totem Base**

	MODEL	BASE	LAMINATE TOP	BEECH TOP	OAK TOP	WALNUT TOP	FORBO TOP
42" DIA, 29" Height	GETT-42D	Powder Coat	\$3885	4168	4264	4264	4264
48" DIA, 29" Height	GETT-48D	Powder Coat	\$4231	4512	4609	4609	4609

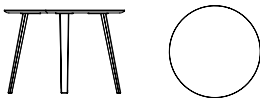

**Gemma Table,  
Wood Base**

	MODEL	BASE	LAMINATE TOP	BEECH TOP	OAK TOP	WALNUT TOP	FORBO TOP
42" DIA, 29" Height	GETD-42D	Wood Base	\$3219	3501	3596	3596	3596
48" DIA, 29" Height	GETD-48D	Wood Base	\$3564	3847	3944	3944	3944

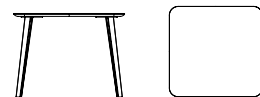

**Gemma Table,  
Wood Base**

	MODEL	BASE	LAMINATE TOP	BEECH TOP	OAK TOP	WALNUT TOP	FORBO TOP
42"x42", 29" Height	GETD-4242	Wood Base	\$3219	3501	3501	3596	3596
48"x48", 29" Height	GETD-4848	Wood Base	\$3564	3847	3847	3944	3944



**Gemma Table,  
Wood Base**

	MODEL	BASE	LAMINATE TOP	BEECH TOP	OAK TOP	WALNUT TOP	FORBO TOP
60"x36", 29" Height	GETD-6036	Wood Base	\$3962	4245	4342	4342	4342
72"x36", 29" Height	GETD-7236	Wood Base	\$4363	4645	4740	4740	4740
84"x42", 29" Height	GETD-8442	Wood Base	\$5078	5360	5455	5455	5455
96"x42", 29" Height	GETD-9642	Wood Base	\$5196	5479	5574	5574	5574

To specify:

Please refer to pages 3-5 for complete specifying information.

Specify all products by their product code.

Pricing Effective: January 2023

---

**5695 Eagle Drive, SE  
Grand Rapids,  
Michigan 49512  
616-975-9260  
lelandfurniture.com**

# Gemma

## January 2023 Price List



# Gemma

Table of Contents	GM2
Specification Information	GM3
Specification Example	GM4
Sled Base, Birch Shell	GM5
Sled Base, Oak Shell	GM6
Sled Base, Walnut Shell	GM7
Wood Base, Birch	GM8
Wood Base, Oak	GM9
Wood Base, Walnut	GM10
Task Base, Birch Shell	GM11
Task Base, Oak Shell	GM12
Task Base, Walnut Shell	GM13

## Chair Model

DESCRIPTION	CODE
Gemma sled base	GEMS
Gemma sled base, upholstered seat	GEMSU
Gemma sled base, upholstered seat and back	GEMSUU
Gemma wood base	GEMW
Gemma wood base, upholstered seat	GEMWU
Gemma wood base, upholstered seat and back	GEMWUU
Gemma task base	GEMT
Gemma task base, upholstered seat	GEMTU
Gemma task base, upholstered seat and back	GEMTUU

## Shell Veneer

DESCRIPTION	CODE
Birch	B
Oak	O
Walnut	W

## Wood Shell & Wood Base Finishes

\*Wood bases default to specified shell type

### STANDARD SHELL/LEG (BIRCH):

DESCRIPTION	CODE
Natural	11
Graphite	25
Transparent Black	29
White Wash II	30
Forest	101M
Willow	108M

### OAK SHELL/LEG:

DESCRIPTION	CODE
Natural White Oak	12
Morel	66M
Evergreen	112M
Sienna	113M
Blue Sky	114M

### WALNUT SHELL/LEG:

DESCRIPTION	CODE
Natural Walnut	08M

## Sled and Task Base Finishes

DESCRIPTION	CODE
Black	B
White	W
Black Textured	BT
White Textured	WT
Matte Mercury	MMR
Matte Mineral	MMN
Matte Burnish	MBN
Matte Foundry	MFN
Matte Blue Sky	MBS
Matte Forest	MFO
Matte Willow	MWL
Matte Sienna	MSN
Matte Pine	MPN
Chrome	C

## Upholstery Selection

Please refer to Leland Textile Program which features textiles and leathers from the following partners:

- Camira
- Green Hides
- Carnegie
- Maharam
- CF Stinson
- Unika Vaev

The complete grade list can be found on our website or you can specify COM/COL. Due to the design of this product, it is recommended that all non pre-approved textile be tested for compatibility.

## Glide Type

### STANDARD:

DESCRIPTION	CODE
Nylon	S

### OPTIONAL:

DESCRIPTION	CODE
Felt	FC

## Caster Options

DESCRIPTION	CODE
Gemma task base	
Hard Floor	HF
Soft Floor	SF

## Stacking note

The Gemma chair does not stack.

Specifications required to create the product code

- Model
- Wood Species
- Shell Finish
- Seat upholstery selection (when applicable)
- Leg Finish
- Back Upholstery Selection (when applicable)
- Glide Type



MODEL

Gemma Wood Base Chair (GEMW)

WOOD SPECIES

Oak (0)

SHELL FINISH

Natural White Oak (12)

SEAT UPHOLSTERY SELECTION

When applicable, enter upholstery grade, COM

LEG FINISH

Natural White Oak (12)

SEAT AND/OR BACK UPHOLSTERY SELECTION

When applicable, enter upholstery grade, COM



GEMMA SLED BASE CHAIR, BIRCH SHELL  
 Design: Altherr Désile Park

GM5



Gemma Sled Base Chair	MODEL		LIST PRICE
Birch shell	GEMS-B	Powder Coat	\$966
W 22 D 22.75 H 30.25 SH 17.75		Chrome	\$1024

Optional Felt Glides: Add \$8.00 net per chair for a set of four (4).



Gemma Sled Base Chair	MODEL	LIST PRICE/GRADE	COM/COL	A	B	C	D	E	F	G	H	I	J	K	L
Birch shell, upholstered seat	GEMSU-B	Powder Coat	\$1087	1134	1158	1182	1206	1231	1255	1279	1303	1327	1351	1376	1400
W 22 D 22.75 H 30.25 SH 17.75		Chrome	\$1145	1192	1216	1240	1264	1288	1313	1337	1361	1385	1409	1433	1457

Optional Felt Glides: Add \$8.00 net per chair for a set of four (4).

COM Yardage: 1 Seat: .75 Yard

Contact Leland Customer Experience for yardage requirements on textiles with repeats.

For COL requirements please contact Leland Customer Experience.



Gemma Sled Base Chair	MODEL	LIST PRICE/ GRADE	COM/COL	A	B	C	D	E	F	G	H	I	J	K	L
Birch shell, upholstered seat and back	GEMSUU-B	Powder Coat	\$1213	1271	1327	1384	1441	1497	1554	1611	1667	1724	1781	1838	1894
W 22 D 22.75 H 30.25 SH 17.75		Chrome	\$1271	1328	1385	1442	1498	1555	1612	1668	1725	1782	1839	1895	1952

Optional Felt Glides: Add \$8.00 net per chair for a set of four (4).

COM Yardage: 1 Seat: 1.25 Yards

Contact Leland Customer Experience for yardage requirements on textiles with repeats.

For COL requirements please contact Leland Customer Experience.

Due to the curvature of the chair shell, we are not able to pattern match on the chair back and seat. If a directional fabric is being specified, add \$56 LIST for a pattern match in the center of the seat and back only.

To specify:

Please refer to pages 3-4 for complete specifying information.

Specify all products by their product code.



GEMMA SLED BASE CHAIR, OAK SHELL  
Design: Altherr Désile Park

GM6



Gemma Sled Base Chair	MODEL		LIST PRICE
Oak shell	GEMS-O	Powder Coat	\$1097
W 22 D 22.75 H 30.25 SH 17.75		Chrome	\$1155

Optional Felt Glides: Add \$8.00 net per chair for a set of four (4).



Gemma Sled Base Chair	MODEL	LIST PRICE/GRADE	COM/COL	A	B	C	D	E	F	G	H	I	J	K	L
Oak shell, upholstered seat	GEMSU-O	Powder Coat	\$1218	1265	1289	1314	1338	1362	1386	1410	1434	1458	1483	1507	1531
W 22 D 22.75 H 30.25 SH 17.75		Chrome	\$1276	1323	1347	1371	1395	1420	1444	1468	1492	1516	1540	1565	1589

Optional Felt Glides: Add \$8.00 net per chair for a set of four (4).

COM Yardage: 1 Seat: .75 Yard

Contact Leland Customer Experience for yardage requirements on textiles with repeats.

For COL requirements please contact Leland Customer Experience.



Gemma Sled Base Chair	MODEL	LIST PRICE/ GRADE	COM/COL	A	B	C	D	E	F	G	H	I	J	K	L
Oak shell, upholstered seat and back	GEMSUU-O	Powder Coat	\$1344	1402	1458	1515	1572	1629	1685	1742	1799	1855	1912	1969	2025
W 22 D 22.75 H 30.25 SH 17.75		Chrome	\$1402	1460	1516	1573	1630	1686	1743	1800	1856	1913	1970	2027	2083

Optional Felt Glides: Add \$8.00 net per chair for a set of four (4).

COM Yardage: 1 Seat: 1.25 Yards

Contact Leland Customer Experience for yardage requirements on textiles with repeats.

For COL requirements please contact Leland Customer Experience.

Due to the curvature of the chair shell, we are not able to pattern match on the chair back and seat. If a directional fabric is being specified, add \$56 LIST for a pattern match in the center of the seat and back only.

To specify:

Please refer to pages 3-4 for complete specifying information.

Specify all products by their product code.

Pricing Effective: January 2023

GEMMA SLED BASE CHAIR, WALNUT SHELL  
Design: Altherr Désile Park

GM7



Gemma Sled Base Chair	MODEL		LIST PRICE
Walnut shell	GEMS-W	Powder Coat	\$1281
W 22 D 22.75 H 30.25 SH 17.75		Chrome	\$1339

Optional Felt Glides: Add \$8.00 net per chair for a set of four (4).



Gemma Sled Base Chair	MODEL	LIST PRICE/GRADE	COM/COL	A	B	C	D	E	F	G	H	I	J	K	L
Walnut shell, upholstered seat	GEMSU-W	Powder Coat	\$1402	1449	1473	1497	1521	1546	1570	1594	1618	1642	1666	1691	1715
W 22 D 22.75 H 30.25 SH 17.75		Chrome	\$1460	1507	1531	1555	1579	1603	1628	1652	1676	1700	1724	1748	1772

Optional Felt Glides: Add \$8.00 net per chair for a set of four (4).

COM Yardage: 1 Seat: .75 Yard

Contact Leland Customer Experience for yardage requirements on textiles with repeats.

For COL requirements please contact Leland Customer Experience.



Gemma Sled Base Chair	MODEL	LIST PRICE/GRADE	COM/COL	A	B	C	D	E	F	G	H	I	J	K	L
Walnut shell, upholstered seat and back	GEMSUU-W	Powder Coat	\$1528	1586	1642	1699	1756	1812	1818	1874	1931	1988	2044	2101	2158
W 22 D 22.75 H 30.25 SH 17.75		Chrome	\$1586	1643	1700	1757	1813	1870	1927	1983	2040	2097	2154	2210	2267

Optional Felt Glides: Add \$8.00 net per chair for a set of four (4).

COM Yardage: 1 Seat: 1.25 Yards

Contact Leland Customer Experience for yardage requirements on textiles with repeats.

For COL requirements please contact Leland Customer Experience.

Due to the curvature of the chair shell, we are not able to pattern match on the chair back and seat. If a directional fabric is being specified, add \$56 LIST for a pattern match in the center of the seat and back only.

To specify:

Please refer to pages 3-4 for complete specifying information.

Specify all products by their product code.

Pricing Effective: January 2023

GEMMA WOOD BASE CHAIR, BIRCH  
Design: Altherr Désile Park

GM8



Gemma Wood Base Chair	MODEL	LIST PRICE
Birch shell/base	GEMW-B	\$1229
W 22 D 21 H SH 18	Optional Felt Glides: Add \$8.00 net per chair for a set of four (4).	



Gemma Wood Base Chair	MODEL	LIST PRICE/GRADE	COM/COL	A	B	C	D	E	F	G	H	I	J	K	L
Birch shell/base, upholstered seat	GEMWU-B		\$1349	1397	1421	1445	1469	1493	1517	1541	1566	1590	1614	1638	1662
W 22 D 21 H SH 18	Optional Felt Glides: Add \$8.00 net per chair for a set of four (4). COM Yardage: 1 Seat: .75 Yard Contact Leland Customer Experience for yardage requirements on textiles with repeats. For COL requirements please contact Leland Customer Experience.														



Gemma Wood Base Chair	MODEL	LIST PRICE/ GRADE	COM/COL	A	B	C	D	E	F	G	H	I	J	K	L
Birch shell/base, upholstered seat and back	GEMWUU-B		\$1465	1523	1579	1636	1693	1749	1806	1863	1919	1976	2033	2090	2146
W 22 D 21 H SH 18	Optional Felt Glides: Add \$8.00 net per chair for a set of four (4). COM Yardage: 1 Seat: 1.25 Yards Contact Leland Customer Experience for yardage requirements on textiles with repeats. For COL requirements please contact Leland Customer Experience. Due to the curvature of the chair shell, we are not able to pattern match on the chair back and seat. If a directional fabric is being specified, add \$56 LIST for a pattern match in the center of the seat and back only.														

To specify:  
Please refer to pages 3-4 for complete specifying information.  
Specify all products by their product code.

Pricing Effective: January 2023

GEMMA WOOD BASE CHAIR, OAK  
Design: Altherr Désile Park

GM9



Gemma Wood Base Chair	MODEL	LIST PRICE
Oak shell/base	GEMW-0	\$1360
W 22 D 21 H SH 18	Optional Felt Glides: Add \$8.00 net per chair for a set of four (4).	



Gemma Wood Base Chair	MODEL	LIST PRICE/GRADE	COM/COL	A	B	C	D	E	F	G	H	I	J	K	L
Oak shell/base, upholstered seat	GEMWU-0		\$1481	1528	1552	1576	1600	1624	1649	1673	1697	1721	1745	1769	1793
W 22 D 21 H SH 18	Optional Felt Glides: Add \$8.00 net per chair for a set of four (4). COM Yardage: 1 Seat: .75 Yard Contact Leland Customer Experience for yardage requirements on textiles with repeats. For COL requirements please contact Leland Customer Experience.														



Gemma Wood Base Chair	MODEL	LIST PRICE/ GRADE	COM/COL	A	B	C	D	E	F	G	H	I	J	K	L
Oak shell/base, upholstered seat and back	GEMWUU-0		\$1607	1664	1721	1778	1834	1891	1948	2004	2061	2118	2175	2231	2288
W 22 D 21 H SH 18	Optional Felt Glides: Add \$8.00 net per chair for a set of four (4). COM Yardage: 1 Seat: 1.25 Yards Contact Leland Customer Experience for yardage requirements on textiles with repeats. For COL requirements please contact Leland Customer Experience. Due to the curvature of the chair shell, we are not able to pattern match on the chair back and seat. If a directional fabric is being specified, add \$56 LIST for a pattern match in the center of the seat and back only.														

To specify:  
Please refer to pages 3-4 for complete specifying information.  
Specify all products by their product code.

Pricing Effective: January 2023

GEMMA WOOD BASE CHAIR, WALNUT  
Design: Altherr Désile Park

GM10



Gemma Wood Base Chair	MODEL	LIST PRICE
Walnut shell/base	GEMW-W	\$1544
W 22 D 21 H SH 18	Optional Felt Glides: Add \$8.00 net per chair for a set of four (4).	



Gemma Wood Base Chair	MODEL	LIST PRICE/GRADE	COM/COL	A	B	C	D	E	F	G	H	I	J	K	L
Walnut shell/base, upholstered seat	GEMWU-W		\$1664	1712	1736	1760	1784	1808	1832	1856	1881	1905	1929	1953	1977
W 22 D 21 H SH 18	Optional Felt Glides: Add \$8.00 net per chair for a set of four (4). COM Yardage: 1 Seat: .75 Yard Contact Leland Customer Experience for yardage requirements on textiles with repeats. For COL requirements please contact Leland Customer Experience.														



Gemma Wood Base Chair	MODEL	LIST PRICE/ GRADE	COM/COL	A	B	C	D	E	F	G	H	I	J	K	L
Walnut shell/base, upholstered seat and back	GEMWUU-W		\$1790	1848	1905	1961	2018	2075	2132	2188	2243	2302	2358	2415	2472
W 22 D 21 H SH 18	Optional Felt Glides: Add \$8.00 net per chair for a set of four (4). COM Yardage: 1 Seat: 1.25 Yards Contact Leland Customer Experience for yardage requirements on textiles with repeats. For COL requirements please contact Leland Customer Experience. Due to the curvature of the chair shell, we are not able to pattern match on the chair back and seat. If a directional fabric is being specified, add \$56 LIST for a pattern match in the center of the seat and back only.														

To specify:  
Please refer to pages 3-4 for complete specifying information.  
Specify all products by their product code.

Pricing Effective: January 2023

GEMMA TASK BASE CHAIR, BIRCH SHELL  
Design: Altherr Désile Park

GM11

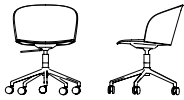

Gemma Task Base Chair	MODEL		LIST PRICE
Birch shell  W 22 D 25.25 H 28.25 - 31 SH 15.75 - 18.5	GEMT-B	Black Textured	\$1313
		Powder Coat	\$1441

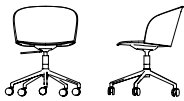

Gemma Task Base Chair	MODEL	LIST PRICE/GRADE	COM/COL	A	B	C	D	E	F	G	H	I	J	K	L
Birch shell, upholstered seat  W 22 D 25.25 H 28.25 - 31 SH 15.75 - 18.5	GEMTU-B	Black Textured	\$1424	1472	1496	1520	1544	1568	1592	1616	1640	1664	1688	1712	1736
		Powder Coat	\$1552	1600	1624	1648	1672	1696	1720	1744	1768	1792	1816	1840	1864

COM Yardage: 1 Seat: .75 Yard  
Contact Leland Customer Experience for yardage requirements on textiles with repeats.  
For COL requirements please contact Leland Customer Experience.

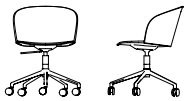

Gemma Task Base Chair	MODEL	LIST PRICE/ GRADE	COM/COL	A	B	C	D	E	F	G	H	I	J	K	L
Birch shell, upholstered seat and back  W 22 D 25.25 H 28.25 - 31 SH 15.75 - 18.5	GEMTUU-B	Black Textured	\$1566	1624	1681	1738	1795	1852	1909	1966	2023	2080	2137	2194	2251
		Powder Coat	\$1694	1752	1809	1866	1923	1980	2037	2094	2151	2208	2265	2322	2379

COM Yardage: 1 Seat: 1.25 Yards  
Contact Leland Customer Experience for yardage requirements on textiles with repeats.  
For COL requirements please contact Leland Customer Experience.  
Due to the curvature of the chair shell, we are not able to pattern match on the chair back and seat. If a directional fabric is being specified, add \$56 LIST for a pattern match in the center of the seat and back only.

To specify:  
Please refer to pages 3-4 for complete specifying information.  
Specify all products by their product code.

GEMMA TASK BASE CHAIR, OAK SHELL  
 Design: Altherr Désile Park

GM12

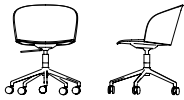

Gemma Task Base Chair	MODEL		LIST PRICE
Oak shell	GEMT-O	Black Textured	\$1370
W 22 D 25.25 H 28.25 - 31 SH 15.75 - 18.5		Powder Coat	\$1498

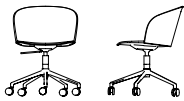

Gemma Task Base Chair	MODEL	LIST PRICE/GRADE	COM/COL	A	B	C	D	E	F	G	H	I	J	K	L
Oak shell, upholstered seat	GEMTU-O	Black Textured	\$1481	1529	1553	1577	1601	1625	1649	1673	1697	1721	1745	1769	1793
W 22 D 25.25 H 28.25 - 31 SH 15.75 - 18.5		Powder Coat	\$1609	1657	1681	1705	1729	1753	1777	1801	1825	1849	1873	1897	1921

COM Yardage: 1 Seat: .75 Yard  
 Contact Leland Customer Experience for yardage requirements on textiles with repeats.  
 For COL requirements please contact Leland Customer Experience.

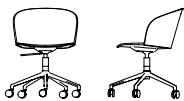

Gemma Task Base Chair	MODEL	LIST PRICE/ GRADE	COM/COL	A	B	C	D	E	F	G	H	I	J	K	L
Oak shell, upholstered seat and back	GEMTUU-O	Black Textured	\$1623	1681	1738	1795	1852	1909	1966	2023	2080	2137	2194	2251	2308
W 22 D 25.25 H 28.25 - 31 SH 15.75 - 18.5		Powder Coat	\$1751	1809	1866	1923	1980	2037	2094	2151	2208	2265	2322	2379	2436

COM Yardage: 1 Seat: 1.25 Yards  
 Contact Leland Customer Experience for yardage requirements on textiles with repeats.  
 For COL requirements please contact Leland Customer Experience.  
 Due to the curvature of the chair shell, we are not able to pattern match on the chair back and seat. If a directional fabric is being specified, add \$56 LIST for a pattern match in the center of the seat and back only.

To specify:  
 Please refer to pages 3-4 for complete specifying information.  
 Specify all products by their product code.

GEMMA TASK BASE CHAIR, WALNUT SHELL  
 Design: Altherr Désile Park

GM13

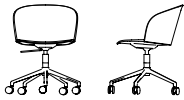

Gemma Task Base Chair	MODEL		LIST PRICE
Walnut shell  W 22 D 25.25 H 28.25 - 31 SH 15.75 - 18.5	GEMT-W	Black Textured	\$1414
		Powder Coat	\$1542

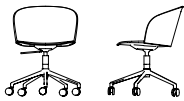

Gemma Task Base Chair	MODEL	LIST PRICE/GRADE	COM/COL	A	B	C	D	E	F	G	H	I	J	K	L
Walnut shell, upholstered seat  W 22 D 25.25 H 28.25 - 31 SH 15.75 - 18.5	GEMTU-W	Black Textured	\$1525	1573	1597	1621	1645	1669	1693	1717	1741	1765	1789	1813	1837
		Powder Coat	\$1652	1700	1724	1748	1772	1796	1820	1844	1868	1892	1916	1940	1964

COM Yardage: 1 Seat: .75 Yard  
 Contact Leland Customer Experience for yardage requirements on textiles with repeats.  
 For COL requirements please contact Leland Customer Experience.

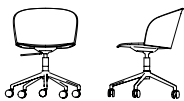

Gemma Task Base Chair	MODEL	LIST PRICE/ GRADE	COM/COL	A	B	C	D	E	F	G	H	I	J	K	L
Walnut shell, upholstered seat and back  W 22 D 25.25 H 28.25 - 31 SH 15.75 - 18.5	GEMTUU-W	Black Textured	\$1667	1725	1782	1839	1896	1953	2010	2067	2124	2181	2238	2295	2352
		Powder Coat	\$1795	1853	1910	1967	2024	2081	2138	2195	2252	2309	2366	2423	2480

COM Yardage: 1 Seat: 1.25 Yards  
 Contact Leland Customer Experience for yardage requirements on textiles with repeats.  
 For COL requirements please contact Leland Customer Experience.  
 Due to the curvature of the chair shell, we are not able to pattern match on the chair back and seat. If a directional fabric is being specified, add \$56 LIST for a pattern match in the center of the seat and back only.

To specify:  
 Please refer to pages 3-4 for complete specifying information.  
 Specify all products by their product code.



---

**5695 Eagle Drive, SE**  
**Grand Rapids,**  
**Michigan 49512**  
**616-975-9260**  
**[lelandfurniture.com](http://lelandfurniture.com)**

# Hammok

## January 2023 Price List



# Hammok

Table of Contents	HS2
Specification Information	HS3
Specification Example	HS4
Cantilever Chair	HS5
Cantilever Chair, Upholstered Onlay	HS5

**Chair Model**

DESCRIPTION	CODE
Hammok cantilever chair	HC
Hammok cantilever chair, upholstered onlay	HCU

**Shell Finish****STANDARD LELAND COLORS****CUSTOM** Specify Custom (01)

\*Please note that Hammok is NOT AVAILABLE in the following finishes:  
Natural Walnut Matte (08M), Natural (11), Natural White Oak Matte (12M)

**Frame Finish**

DESCRIPTION	CODE
Sterling	ST
Warm Grey	WG
Cool Grey	CG
Black	B
White	W
Matte Mercury	MMR
Matte Mineral	MMN
Matte Burnish	MBN
Matte Foundry	MFN

Brushed Stainless Steel (Cantilever only)	BSS
-------------------------------------------	-----

TEXTURED	CODE
Dolphin Textured	DLT
Oxford Textured	OXT
Grey Textured	GT
Black Textured	BT
White Textured	WT
Matte Blue Sky	MBS
Matte Forest	MFO
Matte Sienna	MSN
Matte Willow	MWL

**Upholstered Onlay Selection**

Please refer to Leland Textile Program which features textiles and leathers from the following partners:

- Camira
- Carnegie
- CF Stinson
- Green Hides
- Maharam
- Unika Vaev

The complete grade list can be found on our website or you can specify COM/COL. Due to the design of this product, it is recommended that all non pre-approved textile be tested for compatibility.

**Arm Finish**

Black molded ABS

**Glide Type****STANDARD**

DESCRIPTION	CODE
Nylon (Cantilever only)	S

**Freight Note**

Due to the size and nature of Hammok chairs, the Freight Program does not apply to this product. Please contact Customer Experience for a quote.

**Specifications required to create the product code**

- Model
- Shell Finish
- Frame Finish
- Upholstered Onlay Selection (when applicable)
- Glide Type



**MODEL**

Hammok Cantilever, upholstered onlay (HCU)

**SHELL FINISH**

Natural (11)

**FRAME FINISH**

Sterling (ST)

**UPHOLSTERED ONLAY SELECTION**

When applicable, enter upholstery grade, COM or COL.  
Grade J (J)



**HAMMOK CANTILEVER CHAIR**  
Design: Burkhard Vogtherr

**HS5**

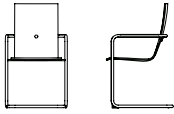

Hammok Cantilever Chair	MODEL	LIST PRICE
Powder coat frame	HC - ___	\$1016
W 22 D 22 H 34.5 SH 17.75 AH 25.875		

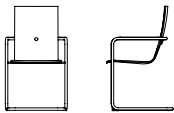

Hammok Cantilever Chair	MODEL	LIST PRICE
Brushed stainless steel frame	HC-BSS	\$1223
W 22 D 22 H 34.5 SH 17.75 AH 25.875		

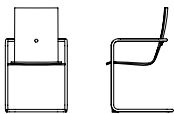

Hammok Cantilever	MODEL	LIST PRICE/ GRADE	COM/ COL	A	B	C	D	E	F	G	H	I	J	K	L
Powder coat frame, upholstered only	HCU - ___	\$1097	1163	1196	1228	1261	1293	1327	1360	1392	1425	1457	1491	1523	
COM Yardage: 1 or 2 chairs: 1.25 yards; 3 or 4 chairs: 2.5 yards Contact Leland Customer Experience for yardage requirements on textiles with repeats. For COL requirements please contact Leland Customer Experience.															
W 22 D 22 H 34.5 SH 17.75 AH 25.875															

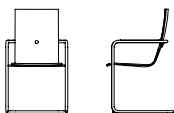

Hammok Cantilever	MODEL	LIST PRICE/ GRADE	COM/ COL	A	B	C	D	E	F	G	H	I	J	K	L
brushed stainless steel frame, upholstered only	HCU-BSS	\$1439	1505	1538	1570	1603	1635	1669	1701	1734	1766	1799	1833	1865	
COM Yardage: 1 or 2 chairs: 1.25 yards; 3 or 4 chairs: 2.5 yards Contact Leland Customer Experience for yardage requirements on textiles with repeats. For COL requirements please contact Leland Customer Experience.															
W 22 D 22 H 34.5 SH 17.75 AH 25.875															

**To specify:**  
Please refer to pages 3-4 for complete specifying information.  
Specify all products by their product code.

**Pricing Effective: January 2023**

---

**5695 Eagle Drive, SE  
Grand Rapids,  
Michigan 49512  
616-975-9260  
lelandfurniture.com**

# Handy Stool

## January 2023 Price List





# Handy Stool

Table of contents	HA2
Specification Information	HA3
Specification Example	HA4
Handy Stool	HA5
Transport/Stacking Dolly	HA8

## Model

DESCRIPTION	CODE
Handy Polypropylene	HYS-P
Handy Polypropylene Shell, Upholstered Onlay	HYS-U
Handy Polypropylene Shell, Wood Onlay	HYS-W
Handy Stool Transport Dolly, Single	HYD-S
Handy Stool Transport Dolly, Double	HYD-D

## Shell Finish/Color

### POLYPROPYLENE SHELL:

DESCRIPTION	CODE
White	WT
Recycled Black	RB
Grey	G
Pistachio	PS
Fawn	FW

### CUSTOM POLYPROPYLENE COLORS

Custom color match is available upon request. Please contact [hello@lelandfurniture.com](mailto:hello@lelandfurniture.com) for further information.

## Upholstered Onlay Selection

Please refer to Leland Textile Program which features textiles and leathers from the following partners:

- Camira
- Carnegie
- CF Stinson
- Green Hides
- Maharam
- Unika Vaev

The complete grade list can be found on our website or you can specify COM/COL. Due to the design of this product, it is recommended that all non pre-approved textiles be tested for compatibility.

## Wood Onlay Selection

DESCRIPTION	CODE
Natural Walnut	08M
Natural White Oak	12

**LELAND COLORS** (on maple)

## Stacking Note

For Handy, ALL models stack as follows: (including upholstered and wood onlay)



Stack of 10: 44"H  
Stack of 5: 29.5"H

## Product Weight

DESCRIPTION	LBS
Handy Polypropylene - HYS-P	7
Handy Polypropylene Shell, Upholstered Onlay - HYS-U	8
Handy Polypropylene Shell, Wood Onlay - HYS-W	8

**Specifications required to create the product code**

- Model
- Shell Finish
- Wood Finish Species (when applicable)
- Wood Finish Code (when applicable)
- Upholstery Option (when applicable)



**MODEL**

Handy Stool (HYS)

**ONLAY SELECTION**

Wood (W)

**SPECIES**

Natural White Oak (12)

**UPHOLSTERED ONLAY SELECTION**

When applicable, enter upholstery grade, COM

**POLYPROPYLENE SHELL FINISH**

White (W)



# HANDY STOOL

Design: Stephen Philips (ARUP), licensed by Sellex

# HA5



## PRICING FOR QUANTITIES 1-49

### Handy Stool

MODEL

LIST PRICE

Polypropylene shell

HYS-P

\$256

W 16 D 14.5 H 18

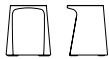

## PRICING FOR QUANTITIES 50-99

### Handy Stool

MODEL

LIST PRICE

Polypropylene shell

HYS-P

\$210

W 16 D 14.5 H 18

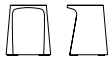

## PRICING FOR QUANTITIES 100+

### Handy Stool

MODEL

LIST PRICE

Polypropylene shell

HYS-P

\$187

W 16 D 14.5 H 18

#### To specify:

Please refer to pages 3-4 for complete specifying information. Specify all products by their product code.

Pricing Effective: January 2023

# HANDY STOOL

Design: Stephen Philips (ARUP), licensed by Sellex

# HA6



### PRICING FOR QUANTITIES 1-49

#### Handy Stool

polypropylene shell,  
upholstered seat onlay

W 16 D 14.5 H 18.25

MODEL	LIST PRICE/GRADE	COM/COL	A	B	C	D	E	F	G	H	I	J	K	L
HYS-U		\$375	399	411	422	434	445	457	468	480	491	503	515	526

COM Yardage: 1 or 2 seats: .75 yard; 3 or 4 seats: 1.5 yards; 5 or 6 seats: 2.25 yards  
Contact Leland Customer Experience for yardage requirements on textiles with repeats.  
For COL requirements please contact Leland Customer Experience.



### PRICING FOR QUANTITIES 50-99

#### Handy Stool

polypropylene shell,  
upholstered seat onlay

W 16 D 14.5 H 18.25

MODEL	LIST PRICE/GRADE	COM/COL	A	B	C	D	E	F	G	H	I	J	K	L
HYS-U		\$329	352	363	375	385	397	408	419	431	442	453	464	476

COM Yardage: 1 or 2 seats: .75 yard; 3 or 4 seats: 1.5 yards; 5 or 6 seats: 2.25 yards  
Contact Leland Customer Experience for yardage requirements on textiles with repeats.  
For COL requirements please contact Leland Customer Experience.



### PRICING FOR QUANTITIES 100+

#### Handy Stool

polypropylene shell,  
upholstered seat onlay

W 16 D 14.5 H 18.25

MODEL	LIST PRICE/GRADE	COM/COL	A	B	C	D	E	F	G	H	I	J	K	L
HYS-U		\$306	330	341	352	363	375	385	397	408	419	431	442	453

COM Yardage: 1 or 2 seats: .75 yard; 3 or 4 seats: 1.5 yards; 5 or 6 seats: 2.25 yards  
Contact Leland Customer Experience for yardage requirements on textiles with repeats.  
For COL requirements please contact Leland Customer Experience.

To specify:

Please refer to pages 3-4 for complete specifying information.  
Specify all products by their product code.

Pricing Effective: January 2023

# HANDY STOOL

Design: Stephen Philips (ARUP), licensed by Sellex

# HA7



## PRICING FOR QUANTITIES 1-49

### Handy Stool

#### MODEL

#### LIST PRICE

Wood onlay

HYS-W

\$404

W 16 D 14.5 H 18.5



## PRICING FOR QUANTITIES 50-99

### Handy Stool

#### MODEL

#### LIST PRICE

Wood onlay

HYS-W

\$358

W 16 D 14.5 H 18.5

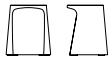

## PRICING FOR QUANTITIES 100+

### Handy Stool

#### MODEL

#### LIST PRICE

Wood onlay

HYS-W

\$335

W 16 D 14.5 H 18.5

#### To specify:

Please refer to pages 3-4 for complete specifying information. Specify all products by their product code.

Pricing Effective: January 2023

# HANDY STOOL DOLLY

Design: Stephen Philips (ARUP), licensed by Sellex

# HA8



Handy Stool	MODEL	LIST PRICE
Single	HYD-S	\$812
W 20.75 D 20.75 H 3.75	*Product stacks 10 high on a single dolly.	

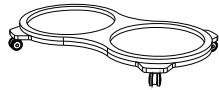

Handy Stool	MODEL	LIST PRICE
Double	HYD-D	\$1135
W 37 D 20.75 H 3.75	*Product stacks 10 high, 2 stacks on a double dolly.	

To specify:  
Please refer to pages 3-4 for complete specifying information.  
Specify all products by their product code.

Pricing Effective: January 2023

---

**5695 Eagle Drive, SE  
Grand Rapids,  
Michigan 49512  
616-975-9260  
lelandfurniture.com**



# Leah Table

## January 2023 Price List

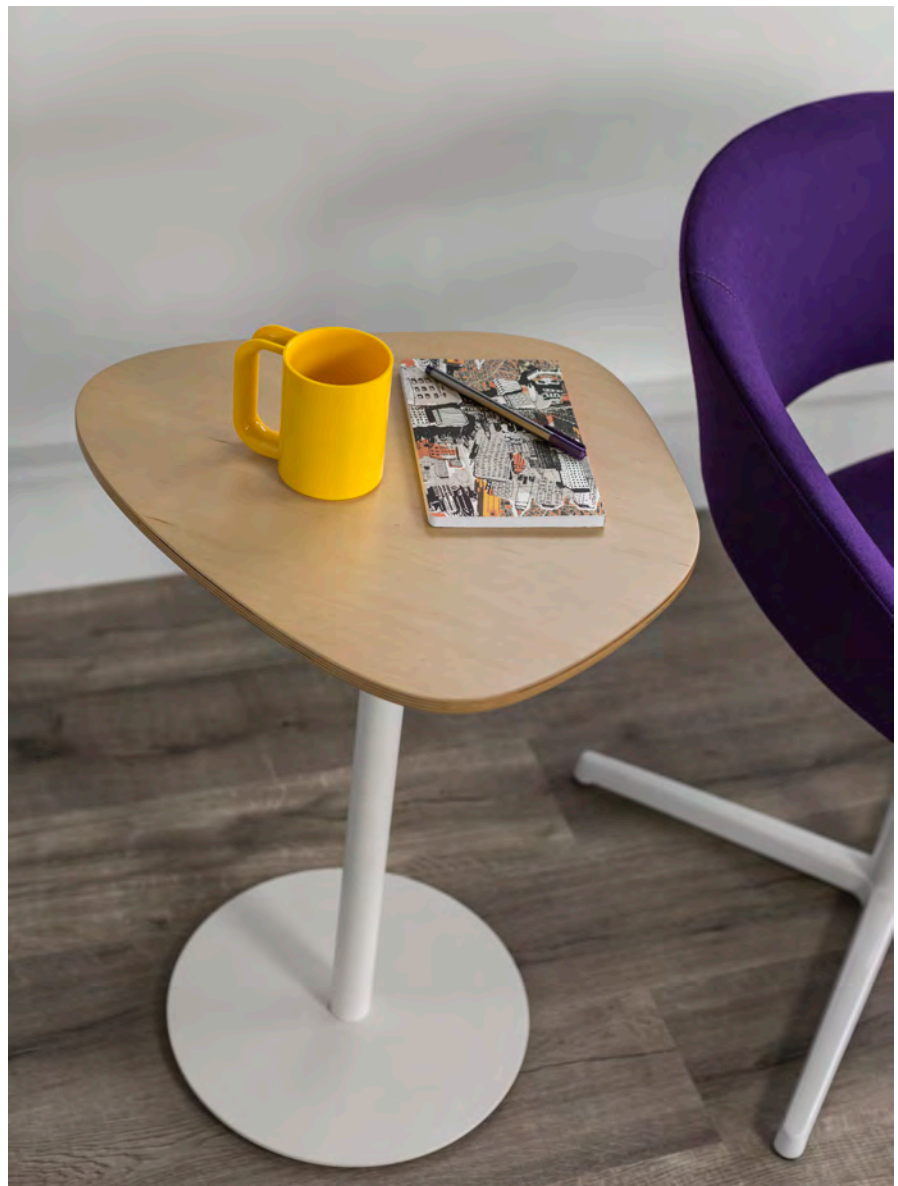

# Leah Table

Table of Contents	LT2
Visual Reference	LT3
Specification Information	LT4
Specification Example	LT5
Ripple Table	LT6
Pond Table	LT7
Puddle Table	LT8
Soft Square Table	LT9
Round Table	LT10

TABLE MODEL		TABLE TOP SIZES	BASE	PAGE
Ripple (LTRP)		18x18 22x22 24x24 30x30	Powder Coat	Page LT6

TABLE MODEL		TABLE TOP SIZES	BASE	PAGE
Pond (LTPN)		22.5x15 45x30	Powder Coat	Page LT7



TABLE MODEL		TABLE TOP SIZES	BASE	PAGE
Puddle (LTPL)		22.5x15 45x30	Powder Coat	Page LT8

TABLE MODEL		TABLE TOP SIZES	BASE	PAGE
Soft Square (LTSS)		18x18 24x24 30x30	Powder Coat	Page LT9

**Model**

DESCRIPTION	CODE
Ripple	LTRP
Pond	LTPN
Puddle	LTPL
Soft Square	LTSS
Round	LTRD

**Top Size****RIPPLE: POND/PUDDLE:**

DESCRIPTION	CODE	DESCRIPTION	CODE
18x18	1818	22.5x15	2315
22x22	2222	45x30	4530
24x24	2424		
30x30	3030		

**SOFT SQUARE: ROUND:**

DESCRIPTION	CODE	DESCRIPTION	CODE
18x18	1818	18D	18D
24x24	2424	24D	24D
30x30	3030	30D	30D

**Top Finish****LELAND COLORS**

DESCRIPTION	CODE
Ash	A
Walnut *quarter cut veneer	W
Maple	MP

**TEXTURED PAINT**

DESCRIPTION	CODE
White	WT
Black	BT
Grey	GT

**SOLID SURFACE**

DESCRIPTION	CODE
Cameo White Corian®	CW
Silverite Corian®	CG
Nocturne Corian®	CB

**BACK PAINTED GLASS**

DESCRIPTION	CODE
White	WG
Black	BG

**LAMINATE**

DESCRIPTION	CODE
Kensington Maple Wilsonart®(10776-60)	LMP
Florence Walnut Wilsonart® (7993-38)	LWN
Black Pionite® (SE101)	LBK
White Wilsonart® (D354-60)	LWH

**Base Height**

DESCRIPTION	CODE
14"	14H
18"	18H
22"	22H
28" (Available with 18x18 Ripple, 18x18 Soft Square, and 18D and 24D Round Tops only)	28H



**Base Finish**

DESCRIPTION	CODE	DESCRIPTION	CODE
White Textured	WT	Grey Textured	GT
Black Textured	BT	Sterling	ST
Dolphin Textured	DT	Oxford Textured	OXT

**Glide Type**

DESCRIPTION
Black HDPE Glide Plate

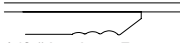
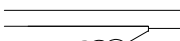
**Edge Type**

DESCRIPTION	DESCRIPTION
6mm Glass Top	1/2" Wood Top
	
1/2" Laminated Top	1/2" Solid Surface Top
	

**Edge Options****LAMINATE EDGE FINISH**

DESCRIPTION	CODE
Natural 11	

**Specifications required to create the product code**

- Model
- Top Size
- Top Finish
- Edge Type
- Edge Finish
- Base Height
- Base Finish



**MODEL**

Ripple (LTRP)

**TOP SIZE**

24x24 (2424)

**TOP FINISH**

Silverite Corian® (CG)

**EDGE TYPE**

Not applicable

**EDGE FINISH**

Not applicable

**BASE HEIGHT**

22" Base (22H)

**BASE FINISH**

Grey Textured Powder coat (GT)



LEAH TABLE  
Design: Bruce Sienkowski

LT6

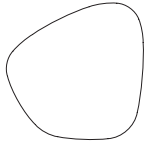

**18" Ripple,**

**Powder Coat Base**

	MODEL	TOP FINISH	TEXTURED PAINT	MAPLE	ASH	WALNUT	LAMINATE	BLACK PAINTED GLASS	SOLID SURFACE
18x18" Top	LTRP-1818	14" Base	\$1052	1158	1158	1214	1277	1480	1458
		18" Base	\$1062	1166	1166	1223	1289	1490	1469
		22" Base	\$1073	1176	1176	1233	1300	1498	1478
		28" Base	\$1095	1198	1198	1253	1320	1509	1489

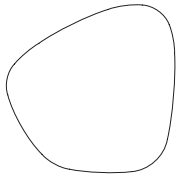

**22" Ripple,**

**Powder Coat Base**

	MODEL	TOP FINISH	TEXTURED PAINT	MAPLE	ASH	WALNUT	LAMINATE	BLACK PAINTED GLASS	SOLID SURFACE
22x22" Top	LTRP-2222	14" Base	\$1155	1267	1267	1338	1401	1848	1814
		18" Base	\$1164	1276	1276	1348	1411	1857	1826
		22" Base	\$1172	1288	1288	1357	1423	1865	1834

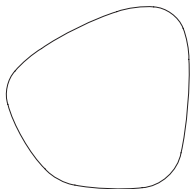

**24" Ripple,**

**Powder Coat Base**

	MODEL	TOP FINISH	TEXTURED PAINT	MAPLE	ASH	WALNUT	LAMINATE	BLACK PAINTED GLASS	SOLID SURFACE
24x24" Top	LTRP-2424	14" Base	\$1251	1373	1373	1447	1466	1988	1945
		18" Base	\$1257	1382	1382	1456	1475	1997	1955
		22" Base	\$1266	1392	1392	1467	1485	2007	1966

To specify:

Please refer to pages 4-5 for complete specifying information.

Specify all products by their product code.

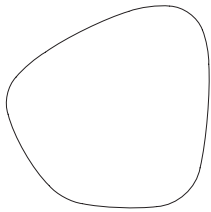

**30" Ripple,  
Powder Coat Base**

	MODEL	TOP FINISH	TEXTURED PAINT	MAPLE	ASH	WALNUT	LAMINATE	BLACK PAINTED GLASS	SOLID SURFACE
30x30" Top	LTRP-3030	14" Base	\$1405	1541	1541	1634	1701	2598	2522
		18" Base	\$1412	1553	1553	1646	1708	2608	2532
		22" Base	\$1423	1563	1563	1654	1718	2615	2542

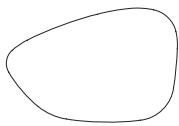

**22.5" Pond,  
Powder Coat Base**

	MODEL	TOP FINISH	TEXTURED PAINT	MAPLE	ASH	WALNUT	LAMINATE	BLACK PAINTED GLASS	SOLID SURFACE
22.5x15" Top	LTPN-2315	14" Base	\$1167	1283	1283	1353	1491	1905	1891
		18" Base	\$1176	1291	1291	1362	1498	1910	1899
		22" Base	\$1183	1301	1301	1373	1510	1923	1911

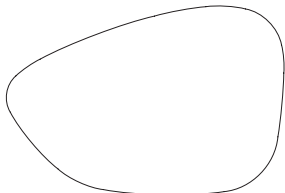

**45" Pond,  
Powder Coat Base**

	MODEL	TOP FINISH	TEXTURED PAINT	MAPLE	ASH	WALNUT	LAMINATE	BLACK PAINTED GLASS	SOLID SURFACE
45x30" Top	LTPN-4530	14" Base	\$1833	2013	2013	2132	2219	3588	3467
		18" Base	\$1841	2021	2021	2142	2230	3597	3478
		22" Base	\$1848	2033	2033	2151	2240	3606	3487

To specify:  
Please refer to pages 4-5 for complete specifying information.  
Specify all products by their product code.

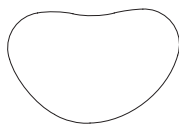

**22.5" Puddle,**

<b>Powder Coat Base</b>	<b>MODEL</b>	<b>TOP FINISH</b>	<b>TEXTURED PAINT</b>	<b>MAPLE</b>	<b>ASH</b>	<b>WALNUT</b>	<b>LAMINATE</b>	<b>BLACK PAINTED GLASS</b>	<b>SOLID SURFACE</b>
22.5x15" Top	LTPL-2315	14" Base	\$1167	1283	1283	1353	1491	1905	1891
		18" Base	\$1176	1291	1291	1362	1498	1910	1899
		22" Base	\$1183	1301	1301	1373	1510	1923	1911

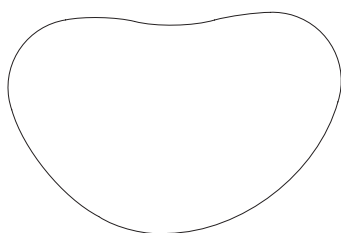

**45" Puddle,**

<b>Powder Coat Base</b>	<b>MODEL</b>	<b>TOP FINISH</b>	<b>TEXTURED PAINT</b>	<b>MAPLE</b>	<b>ASH</b>	<b>WALNUT</b>	<b>LAMINATE</b>	<b>BLACK PAINTED GLASS</b>	<b>SOLID SURFACE</b>
45x30" Top	LTPL-4530	14" Base	\$1833	2013	2013	2132	2219	3588	3467
		18" Base	\$1841	2021	2021	2142	2230	3597	3478
		22" Base	\$1848	2033	2033	2151	2240	3606	3487

To specify:  
Please refer to pages 4-5 for complete specifying information.  
Specify all products by their product code.



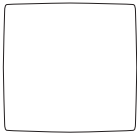

**18" Soft Square,  
Powder Coat Base**

	MODEL	TOP FINISH	TEXTURED PAINT	MAPLE	ASH	WALNUT	LAMINATE	BLACK PAINTED GLASS	SOLID SURFACE
18x18" Top	LTSS-1818	14" Base	\$1161	1272	1272	1335	1398	1622	1604
		18" Base	\$1167	1284	1284	1346	1410	1633	1616
		22" Base	\$1178	1295	1295	1357	1423	1645	1626
		28" Base	\$1189	1306	1306	1371	1437	1662	1640

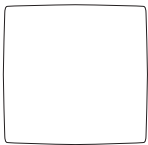

**24" Soft Square,  
Powder Coat Base**

	MODEL	TOP FINISH	TEXTURED PAINT	MAPLE	ASH	WALNUT	LAMINATE	BLACK PAINTED GLASS	SOLID SURFACE
24x24" Top	LLTSS-2424	14" Base	\$1376	1510	1510	1591	1610	2180	2141
		18" Base	\$1385	1520	1520	1603	1619	2189	2149
		22" Base	\$1393	1530	1530	1614	1630	2200	2160

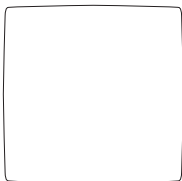

**30" Soft Square,  
Powder Coat Base**

	MODEL	TOP FINISH	TEXTURED PAINT	MAPLE	ASH	WALNUT	LAMINATE	BLACK PAINTED GLASS	SOLID SURFACE
30x30" Top	LTSS-3030	14" Base	\$1544	1697	1697	1797	1862	2845	2776
		18" Base	\$1555	1707	1707	1807	1874	2856	2785
		22" Base	\$1564	1718	1718	1817	1882	2866	2796

To specify:  
Please refer to pages 4-5 for complete specifying information.  
Specify all products by their product code.

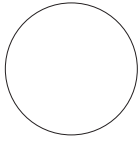

**18" Round,**

**Powder Coat Base**

	MODEL	TOP FINISH	TEXTURED PAINT	MAPLE	ASH	WALNUT	LAMINATE	BLACK PAINTED GLASS	SOLID SURFACE
18" Round Top	LTRD-18D	14" Base	\$1161	1272	1272	1335	1398	1622	1604
		18" Base	\$1167	1284	1284	1346	1410	1633	1616
		22" Base	\$1178	1295	1295	1357	1423	1645	1626
		28" Base	\$1197	1318	1318	1381	1444	1668	1651

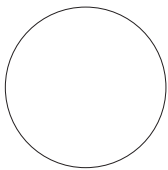

**24" Round,**

**Powder Coat Base**

	MODEL	TOP FINISH	TEXTURED PAINT	MAPLE	ASH	WALNUT	LAMINATE	BLACK PAINTED GLASS	SOLID SURFACE
24" Round Top	LTRD-24D	14" Base	\$1376	1510	1510	1591	1610	2180	2141
		18" Base	\$1385	1520	1520	1603	1619	2189	2149
		22" Base	\$1393	1530	1530	1614	1630	2200	2160
		28" Base	\$1412	1553	1553	1638	1656	2223	2186

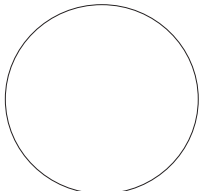

**30" Round,**

**Powder Coat Base**

	MODEL	TOP FINISH	TEXTURED PAINT	MAPLE	ASH	WALNUT	LAMINATE	BLACK PAINTED GLASS	SOLID SURFACE
30" Round Top	LTRD-30D	14" Base	\$1544	1697	1697	1797	1862	2845	2776
		18" Base	\$1555	1707	1707	1807	1874	2856	2785
		22" Base	\$1564	1718	1718	1817	1882	2866	2796

To specify:

Please refer to pages 4-5 for complete specifying information.

Specify all products by their product code.

---

**5695 Eagle Drive, SE  
Grand Rapids,  
Michigan 49512  
616-975-9260  
lelandfurniture.com**

# M2 Seating

## January 2023 Price List

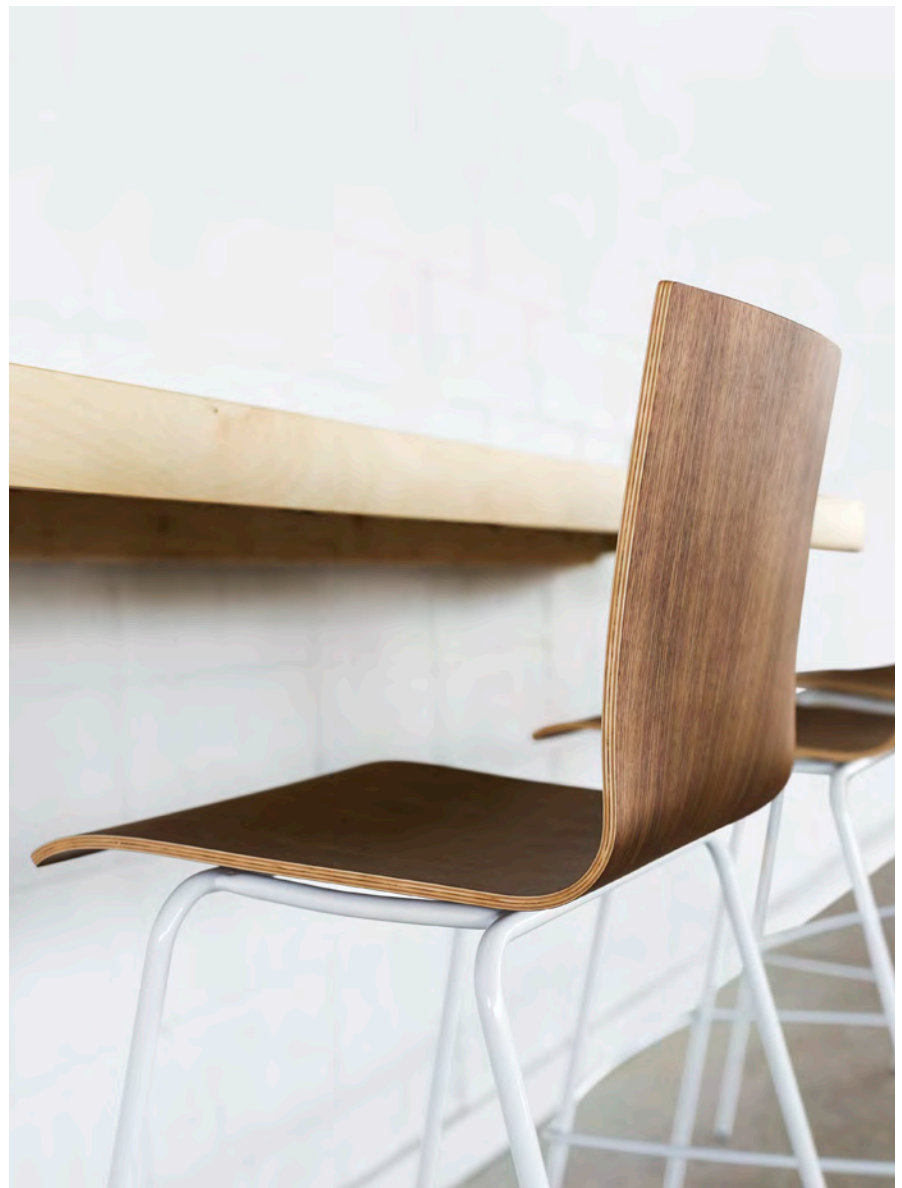

# M2 Seating

Table of Contents	M2S2
Specification Information	M2S3
Specification Example	M2S4
Side Chair	M2S5
Stacking Side Chair	M2S6
Counter Chair	M2S7
Stacking Counter Chair	M2S8
Bar Chair	M2S9
Stacking Bar Chair	M2S10
Transport/Stacking Dolly	M2S11





## Chair Model

DESCRIPTION	CODE
M2 side chair	M2S
M2 side chair, upholstered seat	M2SU
M2 stacking side chair	M2SS
M2 stacking side chair, upholstered seat	M2SSU
M2 counter chair	M2C
M2 counter chair, upholstered seat	M2CU
M2 stacking counter chair	M2CS
M2 stacking counter chair, upholstered seat	M2CSU
M2 bar chair	M2B
M2 bar chair, upholstered seat	M2BU
M2 stacking bar chair	M2BS
M2 stacking bar chair, upholstered seat	M2BSU

## Shell Veneer

DESCRIPTION	CODE
Standard	S
Walnut	W

## Shell Cut Out

DESCRIPTION	CODE	DESCRIPTION	CODE
 Plain	1	 Square	7
 Circle	2	 Soft Square	9
 Rectangle	8		

## Shell Finish

### STANDARD SHELL:

### STANDARD LELAND COLORS

### CUSTOM SPECIFY Custom (01)

\*Please note that M2 Standard Shell is NOT AVAILABLE in the following finishes:  
 Natural Walnut Matte (08M), Natural Beech (09), Natural White Oak Matte (12M)

### WALNUT SHELL:

DESCRIPTION	CODE
Natural Walnut	08

### TWO-TONE SHELL:

DESCRIPTION	CODE
Black/Natural	BKC
White/Natural	WHC

Please note that the product is only available in the Natural Finishes listed above.

## Frame Finish: Powder Coat and Chrome

DESCRIPTION	CODE
Sterling	ST
Warm Grey	WG
Cool Grey	CG
Black	B
White	W
Chrome	C
Matte Mercury	MMR
Matte Mineral	MMN
Matte Burnish	MBN
Matte Foundry	MFN
Matte Blue Sky	MBS
Matte Forest	MFO
Matte Sienna	MSN
Matte Willow	MWL

TEXTURED	CODE
Dolphin Textured	DLT
Oxford Textured	OXT
Grey Textured	GT
Black Textured	BT
White Textured	WT

## Upholstered Onlay Selection

Please refer to Leland Textile Program which features textiles and leathers from the following partners:

- Camira
- Green Hides
- Carnegie
- Maharam
- CF Stinson
- Unika Vaev

The complete grade list can be found on our website or you can specify COM/COL. Due to the design of this product, it is recommended that all non pre-approved textile be tested for compatibility.

## Glide Type

### STANDARD:

DESCRIPTION	CODE
Nylon	S

### OPTIONAL:

Please note that optional glides raise the chair height .5 inch.

DESCRIPTION	CODE
Felt	FC
Floor Saver™ (for VCT type floors)	FS
Metal	M
Rubber	R

## Specifications required to create the product code

- Model
- Shell Veneer
- Cut Out
- Shell Finish
- Frame Finish
- Upholstery Selection (when applicable)
- Glide Type



### MODEL

M2 Side Chair (M2S)

### SHELL VENEER

Standard (S)

### CUT OUT

Rectangle (8)

### SHELL FINISH

Red/Natural (RDC)

### FRAME FINISH

Chrome (C)

### UPHOLSTERY SELECTION

When applicable, enter upholstery grade, COM or COL



M2 SIDE CHAIR  
Design: Leland Design Group

# M2S5



M2 Side Chair	MODEL	FRAME FINISH	LIST PRICE
Standard shell  W 22 D 21.5 H 32.25 SH 17.5	M2S-S	Powder Coat	\$582
		Chrome	\$630

Optional Glides: Add \$8.00 net per chair for a set of four (4). Optional Glides raise chair height .5 inch.



M2 Side Chair	MODEL	LIST PRICE/GRADE	COM/COL	A	B	C	D	E	F	G	H	I	J	K	L
Standard Shell Upholstered seat  W 22 D 21.5 H 32.25 SH 18.5	M2SU-S	Powder Coat	\$662	708	731	755	778	802	825	849	873	897	921	944	969
		Chrome	\$709	755	778	802	825	849	873	897	921	944	969	991	1016

Optional Glides: Add \$8.00 net per chair for a set of four (4). Optional Glides raise chair height .5 inch.  
COM Yardage: 1 to 4 Seats: 1.5 yards  
Contact Leland Customer Experience for yardage requirements on textiles with repeats.  
For COL requirements please contact Leland Customer Experience..



M2 Side Chair	MODEL	FRAME FINISH	LIST PRICE
Walnut shell  W 22 D 21.5 H 32.25 SH 18.5	M2S-W	Powder Coat	\$662
		Chrome	\$709

Optional Glides: Add \$8.00 net per chair for a set of four (4). Optional Glides raise chair height .5 inch.



M2 Side Chair	MODEL	LIST PRICE/GRADE	COM/COL	A	B	C	D	E	F	G	H	I	J	K	L
Walnut Shell, Upholstered seat  W 22 D 21.5 H 32.25 SH 18.5	M2SU-W	Powder Coat	\$741	788	811	835	858	882	906	929	953	977	1001	1024	1048
		Chrome	\$790	836	860	883	907	930	104	978	1002	1025	1049	1074	1097

Optional Glides: Add \$8.00 net per chair for a set of four (4). Optional Glides raise chair height .5 inch.  
COM Yardage: 1 to 4 Seats: 1.5 yards  
Contact Leland Customer Experience for yardage requirements on textiles with repeats.  
For COL requirements please contact Leland Customer Experience.

**To specify:**  
Please refer to pages 3-5 for complete specifying information.  
Specify all products by their product code.



M2 STACKING SIDE CHAIR  
Design: Leland Design Group

# M2S6



M2 Stacking Side Chair	MODEL	FRAME FINISH	LIST PRICE
Standard shell	M2SS-S	Powder Coat	\$612
W 22 D 21.5 H 32.25 SH 17.5		Chrome	\$662
Optional Glides: Add \$8.00 net per chair for a set of four (4). Optional Glides raise chair height .5 inch.			



M2 Stacking Side Chair	MODEL	LIST PRICE/GRADE	COM/COL	A	B	C	D	E	F	G	H	I	J	K	L
Standard Shell Upholstered seat	M2SSU-S	Powder Coat	\$694	740	763	788	811	835	858	882	906	929	953	977	1001
		Chrome	\$741	788	811	835	858	882	906	929	953	977	1001	1024	1048
W 22 D 21.5 H 32.25 SH 18.5	Optional Glides: Add \$8.00 net per chair for a set of four (4). Optional Glides raise chair height .5 inch. COM Yardage: 1 to 4 Seats: 1.5 yards Contact Leland Customer Experience for yardage requirements on textiles with repeats. For COL requirements please contact Leland Customer Experience.														



M2 Stacking Side Chair	MODEL	FRAME FINISH	LIST PRICE
Walnut shell	M2SS-W	Powder Coat	\$694
W 22 D 21.5 H 32.25 SH 18.5		Chrome	\$798
Optional Glides: Add \$8.00 net per chair for a set of four (4). Optional Glides raise chair height .5 inch.			



M2 Stacking Side Chair	MODEL	LIST PRICE/GRADE	COM/COL	A	B	C	D	E	F	G	H	I	J	K	L
Walnut Shell, Upholstered seat	M2SSU-W	Powder Coat	\$773	819	842	866	890	914	938	961	985	1008	1032	1055	1079
		Chrome	\$822	868	893	916	940	963	987	1010	1034	1058	1082	1106	1129
W 22 D 21.5 H 32.25 SH 18.5	Optional Glides: Add \$8.00 net per chair for a set of four (4). Optional Glides raise chair height .5 inch. COM Yardage: 1 to 4 Seats: 1.5 yards Contact Leland Customer Experience for yardage requirements on textiles with repeats. For COL requirements please contact Leland Customer Experience.														

**To specify:**  
Please refer to pages 3-5 for complete specifying information.  
Specify all products by their product code.

M2 COUNTER CHAIR  
Design: Leland Design Group

# M2S7

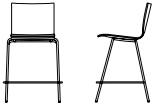

M2 Counter Chair	MODEL	FRAME FINISH	LIST PRICE
Standard shell W 21.5 D 21 H 37 SH 24.5	M2C-S	Powder Coat	\$863
		Chrome	\$914

Optional Glides: Add \$8.00 net per chair for a set of four (4). Optional Glides raise chair height .5 inch.



M2 Counter Chair	MODEL	LIST PRICE/GRADE	COM/COL	A	B	C	D	E	F	G	H	I	J	K	L
Standard Shell Upholstered seat W 21.5 D 21 H 37 SH 25.5	M2CU-S	Powder Coat	\$946	991	1016	1040	1064	1087	1111	1135	1158	1182	1205	1230	1253
		Chrome	\$995	1042	1066	1090	1113	1137	1160	1184	1208	1232	1255	1279	1303

Optional Glides: Add \$8.00 net per chair for a set of four (4). Optional Glides raise chair height .5 inch.  
COM Yardage: 1 to 4 Seats: 1.5 yards  
Contact Leland Customer Experience for yardage requirements on textiles with repeats.  
For COL requirements please contact Leland Customer Experience.



M2 Counter Chair	MODEL	FRAME FINISH	LIST PRICE
Walnut shell W 21.5 D 21 H 37 SH 24.5	M2C-W	Powder Coat	\$946
		Chrome	\$995

Optional Glides: Add \$8.00 net per chair for a set of four (4). Optional Glides raise chair height .5 inch.



M2 Counter Chair	MODEL	LIST PRICE/ GRADE	COM/COL	A	B	C	D	E	F	G	H	I	J	K	L
Walnut Shell, Upholstered seat W 21.5 D 21 H 37 SH 25.5	M2CU-W	Powder Coat	\$1030	1076	1099	1124	1147	1171	1194	1218	1242	1265	1289	1313	1337
		Chrome	\$1079	1126	1149	1173	1197	1220	1244	1267	1292	1315	1339	1362	1387

Optional Glides: Add \$8.00 net per chair for a set of four (4). Optional Glides raise chair height .5 inch.  
COM Yardage: 1 to 4 Seats: 1.5 yards  
Contact Leland Customer Experience for yardage requirements on textiles with repeats.  
For COL requirements please contact Leland Customer Experience.

**To specify:**  
Please refer to pages 3-5 for complete specifying information.  
Specify all products by their product code.

M2 STACKING COUNTER CHAIR  
Design: Leland Design Group

# M2S8



M2 Stacking Counter Chair	MODEL	FRAME FINISH	LIST PRICE
Standard shell	M2CS-S	Powder Coat	\$897
W 21.5 D 21 H 37 SH 24.5		Chrome	\$947

Optional Glides: Add \$8.00 net per chair for a set of four (4). Optional Glides raise chair height .5 inch.



M2 Stacking Counter Chair	MODEL	LIST PRICE/ GRADE	COM/COL	A	B	C	D	E	F	G	H	I	J	K	L
Standard Shell	M2CSU-S	Powder Coat	\$983	1029	1052	1076	1099	1124	1147	1171	1194	1218	1242	1265	1289
Upholstered seat		Chrome	\$1030	1076	1099	1124	1147	1171	1194	1218	1242	1265	1289	1313	1337

W 21.5 D 21 H 37 SH 25.5

Optional Glides: Add \$8.00 net per chair for a set of four (4). Optional Glides raise chair height .5 inch.

COM Yardage: 1 to 4 Seats: 1.5 yards

Contact Leland Customer Experience for yardage requirements on textiles with repeats.

For COL requirements please contact Leland Customer Experience.



M2 Stacking Counter Chair	MODEL	FRAME FINISH	LIST PRICE
Walnut shell	M2CS-W	Powder Coat	\$983
W 21.5 D 21 H 37 SH 24.5		Chrome	\$1030

Optional Glides: Add \$8.00 net per chair for a set of four (4). Optional Glides raise chair height .5 inch.



M2 Stacking Counter Chair	MODEL	LIST PRICE/ GRADE	COM/COL	A	B	C	D	E	F	G	H	I	J	K	L
Walnut Shell,	M2CSU-W	Powder Coat	\$1066	1112	1136	1159	1183	1206	1231	1254	1278	1301	1325	1349	1372
Upholstered seat		Chrome	\$1115	1161	1185	1209	1233	1256	1280	1304	1327	1352	1376	1400	1423

W 21.5 D 21 H 37 SH 25.5

Optional Glides: Add \$8.00 net per chair for a set of four (4). Optional Glides raise chair height .5 inch.

COM Yardage: 1 to 4 Seats: 1.5 yards

Contact Leland Customer Experience for yardage requirements on textiles with repeats.

For COL requirements please contact Leland Customer Experience.

**To specify:**

**Please refer to pages 3-5 for complete specifying information.**

**Specify all products by their product code.**

M2 BAR CHAIR  
Design: Martin Ballendat

# M2S9



M2 Bar Chair	MODEL	FRAME FINISH	LIST PRICE
Standard shell	M2B-S	Powder Coat	\$879
W 21.5 D 22 H 41.5 SH 29.5		Chrome	\$929

Optional Glides: Add \$8.00 net per chair for a set of four (4).



M2 Bar Chair	MODEL	LIST PRICE/GRADE	COM/COL	A	B	C	D	E	F	G	H	I	J	K	L
Standard shell, upholstered seat onlay	M2BU-S	Powder Coat	\$962	1008	1032	1055	1079	1103	1127	1151	1174	1198	1221	1245	1268
		Chrome	\$1014	1061	1084	1109	1132	1156	1179	1203	1227	1251	1275	1298	1322

W 21.5 D 22 H 41.5 SH 30.5

Optional Glides: Add \$8.00 net per chair for a set of four (4). Optional Glides raise chair height .5 inch.  
COM Yardage: 1 to 4 Seats: 1.5 yards  
Contact Leland Customer Experience for yardage requirements on textiles with repeats.  
For COL requirements please contact Leland Customer Experience.



M2 Bar Chair	MODEL	FRAME FINISH	LIST PRICE
Walnut shell	M2B-W	Powder Coat	\$962
W 21.5 D 22 H 41.5 SH 29.5		Chrome	\$1014

Optional Glides: Add \$8.00 net per chair for a set of four (4). Optional Glides raise chair height .5 inch.



M2 Bar Chair	MODEL	LIST PRICE/GRADE	COM/COL	A	B	C	D	E	F	G	H	I	J	K	L
Walnut shell, upholstered seat onlay	M2BU-W	Powder Coat	\$1048	1094	1117	1141	1167	1190	1214	1237	1261	1284	1308	1331	1356
		Chrome	\$1098	1145	1169	1192	1216	1239	1263	1286	1310	1335	1358	1382	1405

W 21.5 D 22 H 41.5 SH 30.5

Optional Glides: Add \$8.00 net per chair for a set of four (4). Optional Glides raise chair height .5 inch.  
COM Yardage: 1 to 4 Seats: 1.5 yards  
Contact Leland Customer Experience for yardage requirements on textiles with repeats.  
For COL requirements please contact Leland Customer Experience.

**To specify:**  
Please refer to pages 3-5 for complete specifying information.  
Specify all products by their product code.

M2 STACKING BAR CHAIR  
Design: Martin Ballendat

# M2S10



M2 Stacking Bar Chair	MODEL	FRAME FINISH	LIST PRICE
Standard shell	M2BS-S	Powder Coat	\$915
W 21.5 D 22 H 41.5 SH 29.5		Chrome	\$963

Optional Glides: Add \$8.00 net per chair for a set of four (4).



M2 Stacking Bar Chair	MODEL	LIST PRICE/GRADE	COM/ COL	A	B	C	D	E	F	G	H	I	J	K	L
Standard shell, upholstered seat onlay	M2BSU-S	Powder Coat	\$999	1045	1068	1092	1115	1139	1162	1187	1210	1234	1258	1281	1306
		Chrome	\$1049	1095	1120	1143	1168	1191	1215	1238	1262	1285	1309	1332	1357

W 21.5 D 22 H 41.5 SH 30.5

Optional Glides: Add \$8.00 net per chair for a set of four (4). Optional Glides raise chair height .5 inch.  
COM Yardage: 1 to 4 Seats: 1.5 yards  
Contact Leland Customer Experience for yardage requirements on textiles with repeats.  
For COL requirements please contact Leland Customer Experience.



M2 Stacking Bar Chair	MODEL	FRAME FINISH	LIST PRICE
Walnut shell	M2BS-W	Powder Coat	\$999
W 21.5 D 22 H 41.5 SH 29.5		Chrome	\$1049

Optional Glides: Add \$8.00 net per chair for a set of four (4). Optional Glides raise chair height .5 inch.



M2 Stacking Bar Chair	MODEL	LIST PRICE/GRADE	COM/ COL	A	B	C	D	E	F	G	H	I	J	K	L
Walnut shell, upholstered seat onlay	M2BSU-W	Powder Coat	\$1083	1129	1153	1176	1201	1223	1248	1272	1296	1320	1343	1367	1390
		Chrome	\$1133	1179	1203	1227	1251	1275	1298	1322	1345	1369	1392	1416	1440

W 21.5 D 22 H 41.5 SH 30.5

Optional Glides: Add \$8.00 net per chair for a set of four (4). Optional Glides raise chair height .5 inch.  
COM Yardage: 1 to 4 Seats: 1.5 yards  
Contact Leland Customer Experience for yardage requirements on textiles with repeats.  
For COL requirements please contact Leland Customer Experience.

**To specify:**  
Please refer to pages 3-5 for complete specifying information.  
Specify all products by their product code.



**M2 Chair Transport/  
Stacking Dolly**

	MODEL	FRAME FINISH	LIST PRICE
W 23 D 33 H 6 (empty)	M2D	Powder Coat	\$1218

To specify:  
Please refer to pages 3-5 for  
complete specifying information.  
Specify all products by their  
product code.

---

**5695 Eagle Drive, SE  
Grand Rapids,  
Michigan 49512  
616-975-9260  
lelandfurniture.com**

# M3 Table

## January 2023 Price List





# M3 Table

Table of Contents	M3T2
Soft Square Pedestal Table Base Visual Reference	M3T4
Soft Square Counter & Bar Base Visual Reference	M3T5
Circle Pedestal Table Base Visual Reference	M3T6
Circle Counter & Bar Table Base Visual Reference	M3T7
Specification Information	M38
Specification Example	M3T10
Small Soft Square Base	M3T11
Medium Soft Square Base	M3T12
Large Soft Square Base	M3T13
Extra Large Soft Square Base	M3T14
Small Soft Square Counter Base	M3T15
Large Soft Square Counter Base	M3T16
Small Soft Square Bar Base	M3T17
Large Soft Square Bar Base	M3T18
Extra Small Circle Base	M3T19
Small Circle Base	M3T20
Medium Circle Base	M3T21
Large Circle Base	M3T22
Extra Large Circle Base	M3T23
Extra-Extra Large Circle Base	M3T24
Extra Small Circle Counter Base	M3T25
Small Circle Counter Base	M3T26
Medium Circle Counter Base	M3T27

# M3 Table

---

Extra Small Circle Bar Base	M3T28
Small Circle Bar Base	M3T29
Large Circle Bar Base	M3T30

---













TABLE MODEL	TABLE TOP SIZES			BASE	COLUMN/BASE	PAGE
Small Soft Square Pedestal Table Base	 24 DIA 30 DIA	 24 x 24 30 x 30	 24 x 30	18" Soft Square	Powder Coat/Powder Coat	Page M3T11
						
Medium Soft Square Pedestal Table Base	 36 DIA	 36 x 36		20" Soft Square	Powder Coat/Powder Coat	Page M3T12
						
Large Soft Square Pedestal Table Base	 42 DIA	 42 x 42		22" Soft Square	Powder Coat/Powder Coat	Page M3T13
						
Extra Large Soft Square Pedestal Table Base	 48 DIA	 48 x 48		24" Soft Square	Powder Coat/Powder Coat	Page M3T14
						





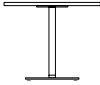

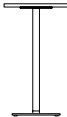



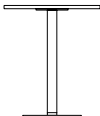

TABLE MODEL	TABLE TOP SIZES			BASE	COLUMN/BASE	PAGE
Small Soft Square Counter Table Base	Round	Square	Rectangle	18" Soft Square	Powder Coat/Powder Coat	Page M3T15
						
	24 DIA	24 x 24	24 x 30			
	30 DIA	30 x 30				
Large Soft Square Counter Table Base	Round	Square		24" Soft Square	Powder Coat/Powder Coat	Page M3T16
						
	36 DIA	36 x 36				
Small Soft Square Bar Table Base	Round	Square	Rectangle	18" Soft Square	Powder Coat/Powder Coat	Page M3T17
						
	24 DIA	24 x 24	24 x 30			
	30 DIA	30 x 30				
Large Soft Square Bar Table Base	Round	Square		24" Soft Square	Powder Coat/Powder Coat	Page M3T18
						
	36 DIA	36 x 36				







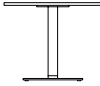







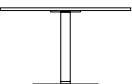



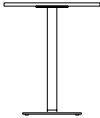



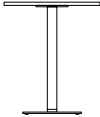

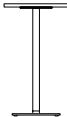

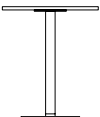



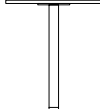

TABLE MODEL	TABLE TOP SIZES		BASE	COLUMN/BASE	PAGE
Extra Small Circle Pedestal Table Base 	Round 24 DIA 	Square 24 x 24 	18"-Diameter	Powder Coat/Powder Coat	Page M3T19
Small Circle Pedestal Table Base 	Round 30 DIA 	Rectangle 24 x 30 	20"-Diameter	Powder Coat/Powder Coat	Page M3T20
Medium Circle Pedestal Table Base 	Round 36 DIA 	Square 30 x 30 	22"-Diameter	Powder Coat/Powder Coat	Page M3T21
Large Circle Pedestal Table Base 	Round 42 DIA 	Square 36 x 36 	26"-Diameter	Powder Coat/Powder Coat	Page M3T22
Extra Large Circle Pedestal Table Base 	Round 48 DIA 	Square 42 x 42 	28"-Diameter	Powder Coat/Powder Coat	Page M3T23
Extra-Extra Large Circle Pedestal Table Base 		Square 48 x 48 	30"-Diameter	Powder Coat/Powder Coat	Page M3T24

TABLE MODEL	TABLE TOP SIZES			BASE	COLUMN/BASE	PAGE
Extra Small Circle Counter Table Base 	Round  24 DIA			18"-Diameter	Powder Coat/Powder Coat	Page M3T25
Small Circle Counter Table Base 	Round  30 DIA	Square  24 x 24	Rectangle  24 x 30	20"-Diameter	Powder Coat/Powder Coat	Page M3T26
Medium Circle Counter Table Base 	Round  36 DIA	Square  30 x 30		22"-Diameter	Powder Coat/Powder Coat	Page M3T27
Extra Small Circle Bar Table Base 	Round  24 DIA			18"-Diameter	Powder Coat/Powder Coat	Page M3T28
Small Circle Bar Table Base 	Round  30 DIA	Square  24 x 24	Rectangle  24 x 30	20"-Diameter	Powder Coat/Powder Coat	Page M3T29
Medium Circle Bar Table Base 	Round  36 DIA	Square  30 x 30		22"-Diameter	Powder Coat/Powder Coat	Page M3T30

**Table Model**

DESCRIPTION	CODE
M3 pedestal table, small soft square base	M3SB
M3 pedestal table, medium soft square base	M3MB
M3 pedestal table, large soft square base	M3LB
M3 pedestal table, extra large soft square base	M3XLB
M3 pedestal table, small counter soft square base	M3SCB
M3 pedestal table, large counter soft square base	M3LCB
M3 pedestal table, small bar soft square base	M3SBB
M3 pedestal table, large bar soft square base	M3LBB
M3 pedestal table, extra large circle base	M3CXSB
M3 pedestal table, small circle base	M3CSB
M3 pedestal table, medium circle base	M3CMB
M3 pedestal table, large circle base	M3CLB
M3 pedestal table, extra large circle base	M3CXLB
M3 pedestal table, extra-extra large circle base	M3CXLB
M3 pedestal table, extra small counter circle base	M3CXSCB
M3 pedestal table, small bar circle base	M3CSCB
M3 pedestal table, medium bar circle base	M3CMCB
M3 pedestal table, extra small bar circle base	M3CXSB
M3 pedestal table, small bar circle base	M3CSBB
M3 pedestal table, medium bar circle base	M3CMBB

**Base Finish: Powder Coat**

DESCRIPTION	CODE
Black Textured	BT
White Textured	WT
Grey Textured	GT
Sterling	ST
Matte Mercury	MMR
Matte Mineral	MMN
Matte Burnish	MBN
Matte Foundry	MFN
Matte Blue Sky	MBS
Matte Forest	MFO
Matte Sienna	MSN
Matte Willow	MWL

**Top Sizes**

ROUND	CODE	SQUARE	CODE	RECTANGLE	CODE
24 DIA	24D	24x24	2424	24x30	2430
30 DIA	30D	30x30	3030		
36 DIA	36D	36x36	3636		
42 DIA	42D	2x42	4242		
48 DIA	48D	48x48	4848		

**Top Finish or Color****WOOD TOPS:****STANDARD LELAND COLORS****CUSTOM SPECIFY** custom (01)

\*Please note that M3 Tables are NOT AVAILABLE in the following finishes:  
Natural Walnut Matte (08M), Natural Beech (09), Natural White Oak Matte (12M)

**LAMINATE TOPS:**

DESCRIPTION	CODE
Grey Laminate Slate Grey Wilsonart®	LGY
Black Laminate Black Pionite®	LBK
White Laminate Designer White Wilsonart®	LWH

Please refer to the Leland Terms and Conditions Guide for a listing of standard laminates.  
For table pricing in laminates not listed, please contact Leland's Customer Experience Department for a quotation.

**FORBO**

DESCRIPTION	CODE
Pearl	4157
Mauve	4172
Pebble	4175
Smokey Blue	4179
Olive	4184

Edge finish options: natural (11) plywood (W2)

## Edge Type

---

### VINYL EDGES:

DESCRIPTION	CODE
1 3/16" flat PVC	V2



3/4" flat PVC	V5
---------------	----

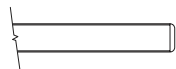

### WOOD EDGES:

DESCRIPTION	CODE
1" beveled plywood	W6



1" flat plywood	W2
-----------------	----

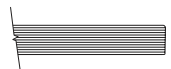

## Edge Finish or Color

---

### VINYL EDGE COLORS:

DESCRIPTION	CODE
Black	B
White	W
Grey	G

### WOOD EDGE COLORS:

#### STANDARD LELAND COLORS

**CUSTOM SPECIFY** Custom (01)

\*Please note that M3 Tables are NOT AVAILABLE in the following finishes:  
Natural Walnut Matte (08M), Natural Beech (09), Natural White Oak Matte (12M)

For laminate tops, edge can be specified in any standard Leland finish. Wood tops and edges must be specified in the same standard Leland finish.



**Specifications required to create the product code**

- Model
- Base Column Finish
- Base Plate Finish
- Top Size
- Top Finish Or Color
- Edge Type
- Edge Finish Or Color



**MODEL**

M3 Pedestal Table,  
Medium Circle Base (M3CMB)

**BASE CENTER**

White Textured (WT)

**TOP SIZE**

42" Diameter (42D)

**TOP COLOR OR FINISH**

White Laminate (LWH)

**EDGE TYPE**

1" Flat Plywood (W2)

**EDGE FINISH OR COLOR**

Natural Maple (11)





M3 PEDESTAL TABLE, SMALL SOFT SQUARE BASE  
 Design: Leland Design Group

M3T11



**M3 Pedestal Table,  
 Powder Coat Base**

	MODEL	TOP SIZE/CODE	LIST PRICE/EDGE CODES:	V2	V5	W6	W2
Small soft square	M3SB-P-P	Wood Top					
		24 DIA - 24D		\$1503	1460	1856	1856
H 29		30 DIA - 30D		\$1960	1918	2511	2511
		24x24 - 2424		\$1503	1460	1856	1856
		30x30 - 3030		\$1960	1918	2511	2511
Round	Square	24x30 - 2430		\$1701	1658	2171	2171
24 DIA	24 x 24						
30 DIA	30 x 30						
		Rectangle					
		24 x 30					
		Laminate Top					
		24 DIA - 24D		\$1341	1299	1634	1634
		30 DIA - 30D		\$1730	1689	2192	2192
		24x24 - 2424		\$1341	1299	1632	1632
		30x30 - 3030		\$1730	1689	2192	2192
		24x30 - 2430		\$1812	1770	2207	2207
		Forbo Top					
		24 DIA - 24D				\$1946	1946
		30 DIA - 30D				\$2335	2335
		24x24 - 2424				\$1946	1946
		30x30 - 3030				\$2335	2335
		24x30 - 2430				\$2417	2417

To specify:  
 Please refer to pages 6-8 for complete specifying information.  
 Specify all products by their product code.

M3 PEDESTAL TABLE, MEDIUM SOFT SQUARE BASE  
 Design: Leland Design Group

# M3T12

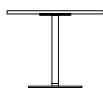

**M3 Pedestal Table,  
 Powder Coat Base**

	MODEL	TOP SIZE/CODE	LIST PRICE/EDGE CODES:	V2	V5	W6	W2
Medium soft square	M3MB-P-P	Wood Top					
		36 DIA - 36D		\$2068	2026	2618	2618
H 29		36x36 - 3636		\$2068	2026	2618	2618
		Laminate Top					
Round		36 DIA - 36D		\$1822	1779	2284	2284
36 DIA		36x36 - 3636		\$1822	1779	2284	2284
Square		Forbo Top					
		36 DIA - 36D				\$2427	2427
		36x36 - 3636				\$2427	2427

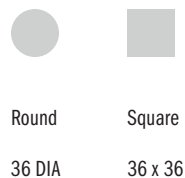



To specify:  
 Please refer to pages 6-8 for complete specifying information.  
 Specify all products by their product code.

M3 PEDESTAL TABLE, LARGE SOFT SQUARE BASE  
 Design: Leland Design Group

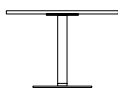
# M3T13



**M3 Pedestal Table,  
 Powder Coat Base**

	MODEL	TOP SIZE/CODE	LIST PRICE/EDGE CODES:	V2	W6	W2
Large soft square	M3LB-P-P	Wood Top				
		42 DIA - 42D		\$2833	3383	3383
H 29		42x42 - 4242		\$2833	3383	3383
 		Laminate Top				
Round		42 DIA - 42D		\$2472	2933	2933
42 DIA		42x42 - 4242		\$2472	2933	2933
Square		Forbo Top				
		42 DIA - 42D			\$3379	3379
		42x42 - 4242			\$3379	3379

To specify:  
 Please refer to pages 6-8 for complete specifying information.  
 Specify all products by their product code.

M3 PEDESTAL TABLE, EXTRA LARGE SOFT SQUARE BASE  
 Design: Leland Design Group

# M3T14

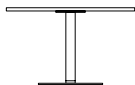

**M3 Pedestal Table,  
 Powder Coat Base**

	MODEL	TOP SIZE/CODE	LIST PRICE/EDGE CODES:	V2	W6	W2
Extra Large soft square	M3XLB-P-P	Wood Top				
		48 DIA - 48D		\$2948	3443	3383
H 29		48x48 - 4848		\$2893	3443	3383
		Laminate Top				
Round		48 DIA - 48D		\$2520	2981	2981
48 DIA		48x48 - 4848		\$2520	2981	2981
Square		48x48 - 4848				
		Forbo Top				
		48 DIA - 48D			\$3889	3889
		48x48 - 4848			\$3889	3889



Round      Square  
 48 DIA      48 x 48



To specify:  
 Please refer to pages 6-8 for complete specifying information.  
 Specify all products by their product code.

M3 PEDESTAL TABLE, SMALL SOFT SQUARE COUNTER BASE  
 Design: Leland Design Group

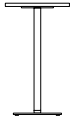
# M3T15



**M3 Pedestal Table,  
 Powder Coat Base**

	MODEL	TOP SIZE/CODE	LIST PRICE/EDGE CODES:	V2	V5	W6	W2
Small soft square counter	M3SCB-P-P	Wood Top					
		24 DIA - 24D		\$1571	1529	1924	1924
H 36		30 DIA - 30D		\$2030	1988	2580	2580
		24x24 - 2424		\$1571	1529	1924	1924
Round	Square	30x30 - 3030		\$2030	1988	2580	2580
		24x30 - 2430		\$1775	1727	2240	2240
24 DIA	24 x 24						
30 DIA	30 x 30						
		Laminate Top					
		24 DIA - 24D		\$1417	1374	1709	1709
		30 DIA - 30D		\$1806	1763	2268	2268
		24x24 - 2424		\$1417	1374	1709	1709
		30x30 - 3030		\$1806	1763	2268	2268
		24x30 - 2430		\$1887	1838	2281	2281
		Forbo Top					
		24 DIA - 24D				\$2057	2057
		30 DIA - 30D				\$2446	2446
		24x24 - 2424				\$2057	2057
		30x30 - 3030				\$2446	2446
		24x30 - 2430				\$2539	2539

To specify:  
 Please refer to pages 6-8 for complete specifying information.  
 Specify all products by their product code.

M3 PEDESTAL TABLE, LARGE SOFT SQUARE COUNTER BASE  
 Design: Leland Design Group

# M3T16

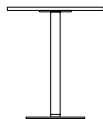

**M3 Pedestal Table,  
 Powder Coat Base**

	MODEL	TOP SIZE/CODE	LIST PRICE/EDGE CODES:	V2	V5	W6	W2
Large soft square counter	M3LCB-P-P	Wood Top					
		36 DIA - 36D		\$2131	2094	2687	2687
H 36		36x36 - 3636		\$2131	2094	2687	2687
		Laminate Top					
Round	Square	36 DIA - 36D		\$1896	1855	2358	2358
36 DIA	36 x 36	36x36 - 3636		\$1896	1855	2358	2358
		Forbo Top					
		36 DIA - 36D				\$2538	2538
		36x36 - 3636				\$2538	2538

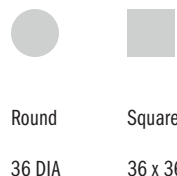



To specify:  
 Please refer to pages 6-8 for complete specifying information.  
 Specify all products by their product code.

M3 PEDESTAL TABLE, SMALL SOFT SQUARE BAR BASE  
 Design: Leland Design Group

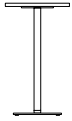
# M3T17



**M3 Pedestal Table,  
 Powder Coat Base**

	MODEL	TOP SIZE/CODE	LIST PRICE/EDGE CODES:	V2	V5	W6	W2
Small soft square bar	M3SBB-P-P	Wood Top					
		24 DIA - 24D		\$1638	1595	1991	1991
H 42		30 DIA - 30D		\$2096	2054	2647	2647
		24x24 - 2424		\$1638	1595	1991	1991
Round	Square	30x30 - 3030		\$2096	2054	2647	2647
		24x30 - 2430		\$1836	1794	2307	2307
24 DIA	24 x 24						
30 DIA	30 x 30						
		Laminate Top					
		24 DIA - 24D		\$1477	1434	1770	1770
		30 DIA - 30D		\$1867	1824	2329	2329
		24x24 - 2424		\$1477	1434	1770	1770
		30x30 - 3030		\$1867	1824	2329	2329
		24x30 - 2430		\$1947	1905	2342	2342
		Forbo Top					
		24 DIA - 24D				\$2081	2081
		30 DIA - 30D				\$2471	2471
		24x24 - 2424				\$2081	2081
		30x30 - 3030				\$2471	2471
		24x30 - 2430				\$2563	2563

To specify:  
 Please refer to pages 6-8 for complete specifying information.  
 Specify all products by their product code.



M3 PEDESTAL TABLE, LARGE SOFT SQUARE BAR BASE  
 Design: Leland Design Group

# M3T18

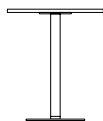

**M3 Pedestal Table,  
 Powder Coat Base**

	MODEL	TOP SIZE/CODE	LIST PRICE/EDGE CODES:	V2	V5	W6	W2
Large soft square bar	M3LBB-P-P	Wood Top					
		36 DIA - 36D		\$2203	2162	2754	2754
H 42		36x36 - 3636		\$2203	2162	2754	2754
		Laminate Top					
Round	Square	36 DIA - 36D		\$1957	1915	2419	2419
36 DIA	36 x 36	36x36 - 3636		\$1957	1915	2419	2419
		Forbo Top					
		36 DIA - 36D				\$2562	2562
		36x36 - 3636				\$2562	2562

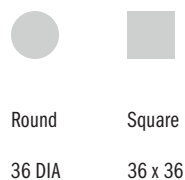



To specify:  
 Please refer to pages 6-8 for complete specifying information.  
 Specify all products by their product code.

M3 PEDESTAL TABLE, EXTRA SMALL CIRCLE BASE  
 Design: Leland Design Group

# M3T19



**M3 Pedestal Table,  
 Powder Coat Base**

	MODEL	TOP SIZE/CODE	LIST PRICE/EDGE CODES:	V2	V5	W6	W2
Extra small circle	M3CXSB-P-P	Wood Top					
		24 DIA - 24D		\$1503	1460	1856	1856
H 29		24x24 - 2424		\$1503	1460	1856	1856
		Laminate Top					
Round	Square	24 DIA - 24D		\$1341	1299	1634	1634
24 DIA	24 x 24	24x24 - 2424		\$1341	1299	1634	1634
		Forbo Top					
		24 DIA - 24D				\$1946	1946
		24x24 - 2424				\$1946	1946

To specify:  
 Please refer to pages 6-8 for complete specifying information.  
 Specify all products by their product code.

M3 PEDESTAL TABLE, SMALL CIRCLE BASE  
 Design: Leland Design Group

# M3T20



**M3 Pedestal Table,  
 Powder Coat Base**

	MODEL	TOP SIZE/CODE	LIST PRICE/EDGE CODES:	V2	V5	W6	W2
Small circle	M3CSB-P-P	Wood Top					
		30 DIA - 30D		\$1960	1918	2511	2511
H 29		24x30 - 2430		\$1701	1658	2171	2171
		Laminate Top					
Round	Rectangle	30 DIA - 30D		\$1730	1689	2192	2192
30 DIA	24 x 30	24x30 - 2430		\$1812	1770	2207	2207
		Forbo Top					
		30 DIA - 30D				\$2335	2335
		24x30 - 2430				\$2417	2417



Round      Rectangle

30 DIA      24 x 30

**To specify:**  
 Please refer to pages 6-8 for complete specifying information.  
 Specify all products by their product code.

**Pricing Effective: January 2023**

M3 PEDESTAL TABLE, MEDIUM CIRCLE BASE  
 Design: Leland Design Group

# M3T21

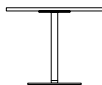

**M3 Pedestal Table,  
 Powder Coat Base**

	MODEL	TOP SIZE/CODE	LIST PRICE/EDGE CODES:	V2	V5	W6	W2
Medium circle	M3CMB-P-P	Wood Top					
		36 DIA - 36D		\$2068	2026	2618	2618
H 29		30x30 - 3030		\$1960	1918	2511	2511
		Laminate Top					
Round		36 DIA - 36D		\$1822	1779	2284	2284
36 DIA		30x30 - 3030		\$1730	1689	2192	2192
Square		30x30 - 3030					
		Forbo Top					
		36 DIA - 36D				\$2427	2427
		30x30 - 3030				\$2335	2335

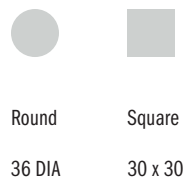



To specify:  
 Please refer to pages 6-8 for complete specifying information.  
 Specify all products by their product code.

M3 PEDESTAL TABLE, LARGE CIRCLE BASE  
 Design: Leland Design Group

# M3T22



**M3 Pedestal Table,  
 Powder Coat Base**

	MODEL	TOP SIZE/CODE	LIST PRICE/EDGE CODES:	V2	V5	W6	W2
Large circle	M3CLB-P-P	Wood Top					
		42 DIA - 42D		\$2833	2791	3383	3383
H 29		36x36 - 3636		\$2068	2026	2618	2618
		Laminate Top					
Round	Square	42 DIA - 42D		\$2472	2430	2933	2933
42 DIA	36 x 36	36x36 - 3636		\$1822	1779	2284	2284
		Forbo Top					
		42 DIA - 42D				\$3379	3379
		36x36 - 3636				\$2427	2427

To specify:  
 Please refer to pages 6-8 for complete specifying information.  
 Specify all products by their product code.

M3 PEDESTAL TABLE, EXTRA LARGE CIRCLE BASE  
 Design: Leland Design Group

# M3T23

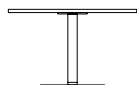

**M3 Pedestal Table,  
 Powder Coat Base**

	MODEL	TOP SIZE/CODE	LIST PRICE/EDGE CODES:	V2	V5	W6	W2
Extra large circle	M3CXLB-P-P	Wood Top					
		48 DIA - 48D		\$2948	2905	3443	3383
H 29		42x42 - 4242		\$2833	2791	3383	3383
		Laminate Top					
Round	Square	48 DIA - 48D		\$2520	2478	2981	2981
48 DIA	42 x 42	42x42 - 4242		\$2472	2430	2933	2933
		Forbo Top					
		48 DIA - 48D				\$3428	3428
		42x42 - 4242				\$3379	3379

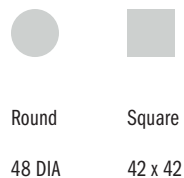

To specify:  
 Please refer to pages 6-8 for complete specifying information.  
 Specify all products by their product code.

M3 PEDESTAL TABLE, EXTRA-EXTRA LARGE CIRCLE BASE  
 Design: Leland Design Group

# M3T24

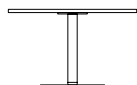

**M3 Pedestal Table,  
 Powder Coat Base**

	MODEL	TOP SIZE/CODE	LIST PRICE/EDGE CODES:	V2	V5	W6	W2
Extra-extra large circle	M3CXXLB-P-P	Wood Top					
		48x48 - 4848		\$2893	2851	3443	3383
H 29		Laminate Top					
		48x48 - 4848		\$2520	2478	2981	2981
Square		Forbo Top					
		48x48 - 4848				\$3428	3428

To specify:  
 Please refer to pages 6-8 for complete specifying information.  
 Specify all products by their product code.

Pricing Effective: January 2023

M3 PEDESTAL TABLE, EXTRA SMALL CIRCLE  
COUNTER BASE

Design: Leland Design Group

# M3T25

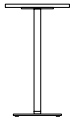

**M3 Pedestal Table,  
Powder Coat Base**

	MODEL	TOP SIZE/CODE	LIST PRICE/EDGE CODES:	V2	V5	W6	W2
Extra small circle counter	M3CXSCB-P-P	Wood Top					
		24 DIA - 24D		\$1571	1529	1924	1924
H 36		Laminate Top					
		24 DIA - 24D		\$1417	1374	1709	1709
Circle		Forbo Top					
		24 DIA - 24D				\$2057	2057



Circle

24 DIA

To specify:

Please refer to pages 6-8 for complete specifying information.

Specify all products by their product code.

Pricing Effective: January 2023



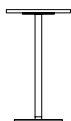

M3 PEDESTAL TABLE, SMALL CIRCLE COUNTER BASE  
 Design: Leland Design Group

# M3T26



**M3 Pedestal Table,  
 Powder Coat Base**

	MODEL	TOP SIZE/CODE	LIST PRICE/EDGE CODES:	V2	V5	W6	W2
Small circle counter	M3CSCB-P-P	Wood Top					
		30 DIA - 30D		\$2030	1988	2580	2580
H 36		24x24 - 2424		\$1571	1529	1924	1924
		24x30 - 2430		\$1775	1727	2240	2240
  		Laminate Top					
Round		30 DIA - 30D		\$1806	1763	2268	2268
Square		24x24 - 2424		\$1417	1374	1709	1709
Rectangle		24x30 - 2430		\$1887	1838	2281	2281
30 DIA		Forbo Top					
		30 DIA - 30D				\$2446	2446
		24x24 - 2424				\$2057	2057
		24x30 - 2430				\$2539	2539

To specify:  
 Please refer to pages 6-8 for complete specifying information.  
 Specify all products by their product code.

M3 PEDESTAL TABLE, MEDIUM CIRCLE COUNTER BASE  
 Design: Leland Design Group

# M3T27

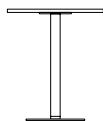

**M3 Pedestal Table,  
 Powder Coat Base**

	MODEL	TOP SIZE/CODE	LIST PRICE/EDGE CODES:	V2	V5	W6	W2
Medium circle counter	M3CMCB-P-P	Wood Top					
		30X30 - 3030		\$2030	1988	2580	2580
H 36		Laminate Top					
		30X30 - 3030		\$1806	1763	2268	2268
Square		Forbo Top					
30 x 30		30X30 - 3030				\$2446	2446

To specify:  
 Please refer to pages 6-8 for complete specifying information.  
 Specify all products by their product code.

M3 PEDESTAL TABLE, EXTRA SMALL CIRCLE BAR BASE  
 Design: Leland Design Group

# M3T28



**M3 Pedestal Table,  
 Powder Coat Base**

	MODEL	TOP SIZE/CODE	LIST PRICE/EDGE CODES:	V2	V5	W6	W2
Extra small circle bar	M3CXSBP-P-P	Wood Top					
		24 DIA - 24D		\$1638	1595	1991	1991
H 42		Laminate Top					
		24 DIA - 24D		\$1477	1434	1770	1770
Circle		Forbo Top					
24 DIA		24 DIA - 24D				\$2081	2081



To specify:  
 Please refer to pages 6-8 for complete specifying information.  
 Specify all products by their product code.

M3 PEDESTAL TABLE, SMALL CIRCLE BAR BASE  
 Design: Leland Design Group

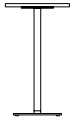
# M3T29



**M3 Pedestal Table,  
 Powder Coat Base**

	MODEL	TOP SIZE/CODE	LIST PRICE/EDGE CODES:	V2	V5	W6	W2
Small circle bar	M3CSBB-P-P	Wood Top					
		30 DIA - 30D		\$2096	2054	2647	2647
H 42		24x24 - 2424		\$1638	1595	1991	1991
		24x30 - 2430		\$1836	1794	2307	2307
  		Laminate Top					
Round		30 DIA - 30D		\$1867	1824	2329	2329
Square		24x24 - 2424		\$1477	1434	1770	1770
Rectangle		24x30 - 2430		\$1947	1905	2342	2342
30 DIA		Forbo Top					
		30 DIA - 30D				\$2471	2471
		24x24 - 2424				\$2081	2081
		24x30 - 2430				\$2563	2563

To specify:  
 Please refer to pages 6-8 for complete specifying information.  
 Specify all products by their product code.

M3 PEDESTAL TABLE, MEDIUM CIRCLE BAR BASE  
 Design: Leland Design Group

# M3T30

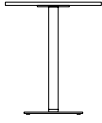

**M3 Pedestal Table,  
 Powder Coat Base**

	MODEL	TOP SIZE/CODE	LIST PRICE/EDGE CODES:	V2	V5	W6	W2
Medium circle bar	M3CMBB-P-P	Wood Top					
		30X30 - 3030		\$2096	2054	2647	2647
H 42		Laminate Top					
		30X30 - 3030		\$1867	1824	2329	2329
Square		Forbo Top					
30 x 30		30X30 - 3030				\$2471	2471

To specify:  
 Please refer to pages 6-8 for complete specifying information.  
 Specify all products by their product code.

---

**5695 Eagle Drive, SE**  
**Grand Rapids,**  
**Michigan 49512**  
**616-975-9260**  
**[lelandfurniture.com](http://lelandfurniture.com)**

# Marquette Seating

## January 2023 Price List



# Marquette Seating

Table of Contents	MQ2
Specification Information	MQ3
Specification Example	MQ4
Stacking Side Chair, Sled Base	MQ5
Counter Chair, Sled Base	MQ6
Bar Chair, Sled Base	MQ7
Marquette Transport/Stacking Dolly	MQ8



**Chair Model**

**SLED BASE:**

DESCRIPTION	CODE
Marquette side chair	MQS
Marquette side chair, upholstered seat	MQSU
Marquette counter chair	MQC
Marquette counter chair, upholstered seat	MQCU
Marquette bar chair	MQB
Marquette bar chair, upholstered seat	MQBU

**Shell Finish**

**STANDARD LELAND COLORS**

**CUSTOM SPECIFY** Custom (01)

\*Please note that Marquette Chair is NOT AVAILABLE in the following finishes:  
 Natural Walnut Matte (08M), Natural Beech (09), Natural White Oak Matte (12M)





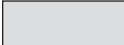









**Shell Style**

SHELL	CODE	SHELL	CODE
Linear	L	Arc	A





**Back Cut Out**

LINEAR CUT OUTS	CODE	ARC CUT OUTS	CODE
Plain back	1	Plain back	1
Circle 	2	Circle 	2
Diamond 	4	Diamond 	4
Grid 	5	Grid 	5
Perforated 	3	Slotted 	6
Dots 	10	Dots 	10
Squares 	11	Reeds 	13
Reeds 	13	Mosaic 	15
Custom cut out	00	Custom cut out	00

**Frame Finish**

DESCRIPTION	CODE
Sterling	ST
Black	B
White	W
Warm Grey	MG
Cool Grey	CG
Chrome	C
Matte Blue Sky	MBS
Matte Forest	MFO
Matte Sienna	MSN
Matte Willow	MWL

TEXTURED	CODE
Dolphin Textured	DLT
Oxford Textured	OXT
Grey Textured	GT
Black Textured	BT
White Textured	WT

**Upholstery Selection**

Please refer to Leland Textile Program which features textiles and leathers from the following partners:

- Camira
- Green Hides
- Carnegie
- Maharam
- CF Stinson
- Unika Vaev

The complete grade list can be found on our website or you can specify COM/COL. Due to the design of this product, it is recommended that all non pre-approved textile be tested for compatibility.

**Glide Type**

STANDARD:	DESCRIPTION	CODE
	Poly	S

  

OPTIONAL:	DESCRIPTION	CODE
	Felt	FC



MARQUETTE STACKING SIDE CHAIR, SLED BASE  
Design: Leland Design Group

MQ5

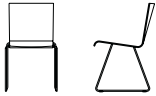

Marquette Side Chair	MODEL	FRAME FINISH	LIST PRICE
Sled base, linear shell	MQS-L	Powder Coat	\$478
W 19.75 D 21 H 34 SH 18.5		Chrome	\$532

Optional Glides: Add \$8.00 net per chair for a set of four (4).

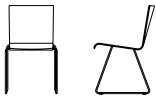

Marquette Side Chair	MODEL	LIST PRICE/GRADE	COM/COL	A	B	C	D	E	F	G	H	I	J	K	L
Sled base, linear shell upholstered seat onlay	MQSU-L	Powder Coat	\$569	594	607	620	633	646	657	670	683	695	708	719	732
		Chrome	\$625	651	664	676	688	700	714	727	739	751	763	776	789

W 19.75 D 21 H 34 SH 18.75

COM Yardage: 1-2 seats: .75 yard; 3-4 seats: 1.25 yards; 5-6 seats: 1.75 yards  
Contact Leland Customer Service for yardage requirements on textiles with repeats.  
For COL requirements please contact Leland Customer Experience.



Marquette Side Chair	MODEL	FRAME FINISH	LIST PRICE
Sled base, arc shell	MQS-A	Powder Coat	\$478
W 19.75 D 21 H 34 SH 18.5		Chrome	\$532

Optional Glides: Add \$8.00 net per chair for a set of four (4).



Marquette Side Chair	MODEL	LIST PRICE/GRADE	COM/COL	A	B	C	D	E	F	G	H	I	J	K	L
Sled base, arc shell upholstered seat onlay	MQSU-A	Powder Coat	\$569	594	607	620	633	646	657	670	683	695	708	719	732
		Chrome	\$625	651	664	676	688	700	714	727	739	751	763	776	789

W 19.75 D 21 H 34 SH 18.75

COM Yardage: 1-2 seats: .75 yard; 3-4 seats: 1.25 yards; 5-6 seats: 1.75 yards  
Contact Leland Customer Service for yardage requirements on textiles with repeats.  
For COL requirements please contact Leland Customer Experience.

**To specify:**  
Please refer to pages 3-5 for complete specifying information.  
Specify all products by their product code.

Pricing Effective: January 2023

MARQUETTE COUNTER CHAIR, SLED BASE  
Design: Leland Design Group

MQ6

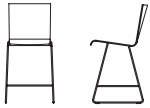

Marquette Counter Chair	MODEL	FRAME FINISH	LIST PRICE
Sled base, linear shell  W 19.25 D 22.5 H 39.75 SH 25.25	MQC-L	Powder Coat	\$788
		Chrome	\$862

Optional Glides: Add \$8.00 net per chair for a set of four (4). Optional Glides raise chair height .5 inch.

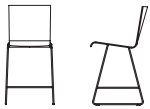

Marquette Counter Chair	MODEL	LIST PRICE/GRADE	COM/COL	A	B	C	D	E	F	G	H	I	J	K	L
Sled base, linear shell upholstered seat onlay  W 19.25 D 22.5 H 39.75 SH 25.5	MQCU-L	Powder Coat	\$886	914	926	939	951	963	975	988	1001	1013	1025	1037	1051
		Chrome	\$961	987	1000	1012	1024	1036	1049	1063	1075	1087	1099	1112	1125

COM Yardage: 1-2 seats: .75 yard; 3-4 seats: 1.25 yards; 5-6 seats: 1.75 yards  
Contact Leland Customer Service for yardage requirements on textiles with repeats.  
For COL requirements please contact Leland Customer Experience.

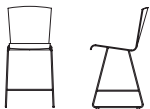

Marquette Counter Chair	MODEL	FRAME FINISH	LIST PRICE
Sled base, arc shell  W 19.25 D 22.5 H 39.75 SH 25.25	MQC-A	Powder Coat	\$788
		Chrome	\$862

Optional Glides: Add \$8.00 net per chair for a set of four (4). Optional Glides raise chair height .5 inch.



Marquette Counter Chair	MODEL	LIST PRICE/GRADE	COM/COL	A	B	C	D	E	F	G	H	I	J	K	L
Sled base, arc shell upholstered seat onlay  W 19.25 D 22.5 H 39.75 SH 25.5	MQCU-A	Powder Coat	\$886	914	926	939	951	963	975	988	1001	1013	1025	1037	1051
		Chrome	\$961	987	1000	1012	1024	1036	1049	1063	1075	1087	1099	1112	1125

COM Yardage: 1-2 seats: .75 yard; 3-4 seats: 1.25 yards; 5-6 seats: 1.75 yards  
Contact Leland Customer Service for yardage requirements on textiles with repeats.  
For COL requirements please contact Leland Customer Experience.

**To specify:**  
Please refer to pages 3-5 for complete specifying information.  
Specify all products by their product code.

**MARQUETTE BAR CHAIR, SLED BASE**  
Design: Leland Design Group

**MQ7**

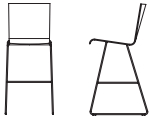

Marquette Bar Chair	MODEL	FRAME FINISH	LIST PRICE
sled base, linear shell	MQB-L	Powder Coat	\$803
W 19.5 D 23 H 44 SH 30.25		Chrome	\$894

Optional Glides: Add \$8.00 net per chair for a set of four (4). Optional Glides raise chair height .5 inch.

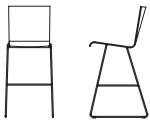

Marquette Bar Chair	MODEL	LIST PRICE/GRADE	COM/COL	A	B	C	D	E	F	G	H	I	J	K	L
Sled base, linear shell upholstered seat onlay	MQBU-L	Powder Coat	\$902	928	941	953	965	978	990	1003	1016	1029	1041	1053	1066
		Chrome	\$994	1021	1033	1046	1058	1070	1083	1095	1109	1121	1133	1146	1158

W 19.5 D 23 H 44 SH 30.5

COM Yardage: 1-2 seats: .75 yard; 3-4 seats: 1.25 yards; 5-6 seats: 1.75 yards  
Contact Leland Customer Service for yardage requirements on textiles with repeats.  
For COL requirements please contact Leland Customer Experience.

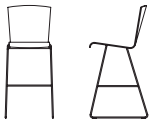

Marquette Bar Chair	MODEL	FRAME FINISH	LIST PRICE
Sled base, arc shell	MQB-A	Powder Coat	\$803
W 19.5 D 23 H 44 SH 30.25		Chrome	\$894

Optional Glides: Add \$8.00 net per chair for a set of four (4). Optional Glides raise chair height .5 inch.



Marquette Bar Chair	MODEL	LIST PRICE/ GRADE	COM/COL	A	B	C	D	E	F	G	H	I	J	K	L
Sled base, arc shell upholstered seat onlay	MQBU-A	Powder Coat	\$902	928	941	953	965	978	990	1003	1016	1029	1041	1053	1066
		Chrome	\$994	1021	1033	1046	1058	1070	1083	1095	1109	1121	1133	1146	1158

W 19.5 D 23 H 44 SH 30.5

COM Yardage: 1-2 seats: .75 yard; 3-4 seats: 1.25 yards; 5-6 seats: 1.75 yards  
Contact Leland Customer Service for yardage requirements on textiles with repeats.  
For COL requirements please contact Leland Customer Experience.

**To specify:**  
Please refer to pages 3-5 for complete specifying information.  
Specify all products by their product code.

MARQUETTE TRANSPORT/STACKING DOLLY  
 Design: Leland Design Group

MQ8

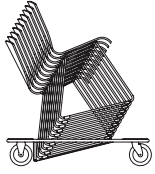

**Marquette Transport/  
 Stacking Dolly**

	MODEL	FRAME FINISH	LIST PRICE
W 23 D 33 H 6 (empty)	MQD	Powder Coat	\$1041
W 23 D 33 H 38 (with 10 side chairs)		Marquette Transport/Stacking Dolly handles up to 10 Marquette side chairs. Little Marquette chairs do not stack on dolly.	

**PROPER STACKING OF MARQUETTE SLED BASE CHAIRS  
 (10 CHAIRS MAXIMUM)**

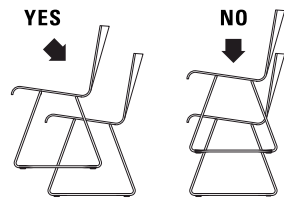

To specify:  
 Please refer to pages 3-5 for complete specifying information.  
 Specify all products by their product code.

Pricing Effective: January 2023

---

**5695 Eagle Drive, SE  
Grand Rapids,  
Michigan 49512  
616-975-9260  
lelandfurniture.com**

# Mass

## January 2023 Price List





# Mass

Table of Contents	MA2
Specification Information	MA3
Specification Example	MA4
Stacking Side Chair	MA5
Stacking Side Chair, Upholstered Seat	MA6
Stacking Arm Chair	MA7
Stacking Arm Chair, Upholstered Seat	MA8
Stacking Counter Chair	MA9
Stacking Counter Chair, Upholstered Seat	MA10
Stacking Bar Chair	MA11
Stacking Bar Chair, Upholstered Seat	MA12
Transport/Stacking Dolly	MA13
Ganging Device	MA13

**Chair Model**

DESCRIPTION	CODE
Mass stacking side chair	Mass
Mass stacking side chair, upholstered seat	MassU
Mass stacking arm chair	MASA
Mass stacking arm chair, upholstered seat	MASAU
Mass stacking counter chair	MASC
Mass stacking counter chair, upholstered seat	MASCU
Mass stacking bar chair	MASB
Mass stacking bar chair, upholstered seat	MASBU
Mass transport/stacking dolly	MASD

**Seat/Back Color**

**POLYPROPYLENE SHELL:**

DESCRIPTION	CODE
White	WT
Recycled Black	RB
Grey	G
Pistachio	PS
Fawn	FW

**CUSTOM POLYPROPYLENE COLORS**

Custom color match is available upon request. Please contact hello@lelandfurniture.com for further information

**Onlay Selection**

Please refer to Leland Textile Program which features textiles and leathers from the following partners:

- Camira
- Carnegie
- CF Stinson
- Green Hides
- Maharam
- Unika Vaev

The complete grade list can be found at [www.lelandfurniture.com/resources](http://www.lelandfurniture.com/resources) or you can specify COM/COL. Due to the design of this product, it is recommended that all non pre-approved textile be tested for compatibility.

**Frame Finish**

DESCRIPTION	CODE
Chrome	C
Sterling	ST
White Textured	WT
Black Textured	BT
Grey Textured	GT
Black	B
White	W

**Glide Type**

**STANDARD:**

DESCRIPTION	CODE
Nylon	S

**OPTIONAL:**

DESCRIPTION	CODE
Felt	FC

**Stacking Note**

Mass side chair, arm chair and bar chair models stack as follows (includes upholstered):

**SIDE CHAIR:**

Floor: 15 High  
Dolly: 40 High

**ARM CHAIR:**

Floor: 12 High  
Dolly: 40 High

**BAR & COUNTER CHAIR:**

Floor: 8 High

**Chair Weight**

**SIDE CHAIR:** 12 lbs

**ARM CHAIR:** 14 lbs

**Specifications required to create the product code**

- Model
- Shell Finish
- Upholstered Onlay Selection (when applicable)
- Frame Finish
- Glide or Caster Type

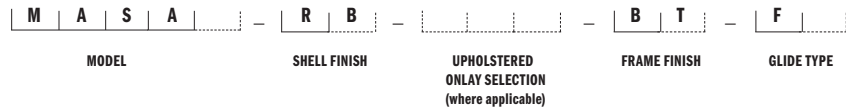

**MODEL**

Mass stacking arm chair (MASA)

**SHELL FINISH**

Recycled Black (RB)

**UPHOLSTERED ONLAY SELECTION**

When applicable, enter upholstery grade, COM



**FRAME FINISH**

Black Textured (BT)

**GLIDE TYPE**

Standard Felt (F)



**MASS STACKING SIDE CHAIR**  
 Design: ITEMdesignworks, licensed by Sellex

**MA5**



**PRICING FOR QUANTITIES 1-99**

<b>Mass Stacking Side Chair</b>	<b>MODEL</b>	<b>FRAME FINISH</b>	<b>LIST PRICE</b>
Polypropylene shell	MASS	Powder Coat	\$364
W 20.5 D 20.5 H 32.25 SH 18		Chrome	\$427



**PRICING FOR QUANTITIES 100-299**

<b>Mass Stacking Side Chair</b>	<b>MODEL</b>	<b>FRAME FINISH</b>	<b>LIST PRICE</b>
Polypropylene shell	MASS	Powder Coat	\$348
W 20.5 D 20.5 H 32.25 SH 18		Chrome	\$403



**PRICING FOR QUANTITIES 300+**

<b>Mass Stacking Side Chair</b>	<b>MODEL</b>	<b>FRAME FINISH</b>	<b>LIST PRICE</b>
Polypropylene shell	MASS	Powder Coat	\$326
W 20.5 D 20.5 H 32.25 SH 18		Chrome	\$381

**To specify:**  
 Please refer to pages 3-4 for complete specifying information.  
 Specify all products by their product code.

**Pricing Effective: January 2023**

MASS STACKING SIDE CHAIR, UPHOLSTERED SEAT  
 Design: ITEMdesignworks, licensed by Sellex

MA6



PRICING FOR QUANTITIES 1-99

Mass Stacking Side Chair

MODEL	LIST PRICE/GRADE	COM/COL	A	B	C	D	E	F	G	H	I	J	K	L	
Polypropylene shell, upholstered seat onlay	MASSU	Powder Coat	\$502	537	571	607	642	676	711	746	780	815	849	884	919
		Chrome	\$565	600	634	669	704	738	774	809	843	878	912	947	982

W 20.5 D 20.5 H 32.25 SH 18

COM Yardage: 1-3 seats: .5 yard  
 Contact Leland Customer Experience for yardage requirements on textiles with repeats.  
 For COL requirements please contact Leland Customer Experience.



PRICING FOR QUANTITIES 100-299

Mass Stacking Side Chair

MODEL	LIST PRICE/GRADE	COM/COL	A	B	C	D	E	F	G	H	I	J	K	L	
Polypropylene shell, upholstered seat onlay	MASSU	Powder Coat	\$473	508	543	578	612	647	681	716	751	785	820	856	890
		Chrome	\$532	567	602	636	671	707	741	776	811	845	880	915	949

W 20.5 D 20.5 H 32.25 SH 18

COM Yardage: 1-3 seats: .5 yard  
 Contact Leland Customer Experience for yardage requirements on textiles with repeats.  
 For COL requirements please contact Leland Customer Experience.



PRICING FOR QUANTITIES 300+

Mass Stacking Side Chair

MODEL	LIST PRICE/GRADE	COM/COL	A	B	C	D	E	F	G	H	I	J	K	L	
Polypropylene shell, upholstered seat onlay	MASSU	Powder Coat	\$447	482	517	551	586	621	655	691	726	760	795	830	864
		Chrome	\$503	538	572	608	643	677	712	747	781	816	851	885	920

W 20.5 D 20.5 H 32.25 SH 18

COM Yardage: 1-3 seats: .5 yard  
 Contact Leland Customer Experience for yardage requirements on textiles with repeats.  
 For COL requirements please contact Leland Customer Experience.

To specify:  
 Please refer to pages 3-4 for complete specifying information.  
 Specify all products by their product code.

Pricing Effective: January 2023

**MASS STACKING ARM CHAIR**  
 Design: ITEMdesignworks, licensed by Sellex

**MA7**



**PRICING FOR QUANTITIES 1-99**

<b>Mass Stacking Arm Chair</b>	<b>MODEL</b>	<b>FRAME FINISH</b>	<b>LIST PRICE</b>
Polypropylene shell	MASA	Powder Coat	\$504
W 20.5 D 20.5 H 32.25 SH 18		Chrome	\$566



**PRICING FOR QUANTITIES 100-299**

<b>Mass Stacking Arm Chair</b>	<b>MODEL</b>	<b>FRAME FINISH</b>	<b>LIST PRICE</b>
Polypropylene shell	MASA	Powder Coat	\$473
W 20.5 D 20.5 H 32.25 SH 18		Chrome	\$537



**PRICING FOR QUANTITIES 300+**

<b>Mass Stacking Arm Chair</b>	<b>MODEL</b>	<b>FRAME FINISH</b>	<b>LIST PRICE</b>
Polypropylene shell	MASA	Powder Coat	\$448
W 20.5 D 20.5 H 32.25 SH 18		Chrome	\$503

**To specify:**  
 Please refer to pages 3-4 for complete specifying information.  
 Specify all products by their product code.

**Pricing Effective: January 2023**

**MASS STACKING ARM CHAIR, UPHOLSTERED SEAT**  
 Design: ITEMdesignworks, licensed by Sellex

**MA8**



**PRICING FOR QUANTITIES 1-99**

**Mass Stacking Arm Chair**

MODEL	LIST PRICE/GRADE	COM/COL	A	B	C	D	E	F	G	H	I	J	K	L
MASAU	Powder Coat	\$588	624	658	693	728	762	797	832	866	901	936	970	1006
	Chrome	\$653	688	723	758	793	827	862	897	931	966	1001	1035	1070

W 20.5 D 20.5 H 32.25 SH 18

COM Yardage: 1-3 seats: .5 yard  
 Contact Leland Customer Experience for yardage requirements on textiles with repeats.  
 For COL requirements please contact Leland Customer Experience.



**PRICING FOR QUANTITIES 100-299**

**Mass Stacking Arm Chair**

MODEL	LIST PRICE/GRADE	COM/COL	A	B	C	D	E	F	G	H	I	J	K	L
MASAU	Powder Coat	\$555	591	626	660	695	730	764	799	834	868	903	938	973
	Chrome	\$617	652	687	721	757	792	826	861	896	930	965	1000	1034

W 20.5 D 20.5 H 32.25 SH 18

COM Yardage: 1-3 seats: .5 yard  
 Contact Leland Customer Experience for yardage requirements on textiles with repeats.  
 For COL requirements please contact Leland Customer Experience.



**PRICING FOR QUANTITIES 300+**

**Mass Stacking Arm Chair**

MODEL	LIST PRICE/GRADE	COM/COL	A	B	C	D	E	F	G	H	I	J	K	L
MASAU	Powder Coat	\$525	560	594	629	664	698	733	768	802	837	873	907	942
	Chrome	\$582	616	651	686	720	755	791	825	860	895	929	964	999

W 20.5 D 20.5 H 32.25 SH 18

COM Yardage: 1-3 seats: .5 yard  
 Contact Leland Customer Experience for yardage requirements on textiles with repeats.  
 For COL requirements please contact Leland Customer Experience.

**To specify:**  
 Please refer to pages 3-4 for complete specifying information.  
 Specify all products by their product code.

**Pricing Effective: January 2023**

**MASS STACKING COUNTER CHAIR**  
 Design: ITEMdesignworks, licensed by Sellex

**MA9**



**PRICING FOR QUANTITIES 1-99**

<b>Mass Stacking Counter Chair</b>	<b>MODEL</b>	<b>FRAME FINISH</b>	<b>LIST PRICE</b>
Polypropylene shell	MASC	Powder Coat	\$651
W 21.75 D 20.5 H 40.75 SH 25		Chrome	\$714



**PRICING FOR QUANTITIES 100-299**

<b>Mass Stacking Counter Chair</b>	<b>MODEL</b>	<b>FRAME FINISH</b>	<b>LIST PRICE</b>
Polypropylene shell	MASC	Powder Coat	\$615
W 21.75 D 20.5 H 40.75 SH 25		Chrome	\$675



**PRICING FOR QUANTITIES 300+**

<b>Mass Stacking Counter Chair</b>	<b>MODEL</b>	<b>FRAME FINISH</b>	<b>LIST PRICE</b>
Polypropylene shell	MASC	Powder Coat	\$580
W 21.75 D 20.5 H 40.75 SH 25		Chrome	\$616

**To specify:**  
 Please refer to pages 3-4 for complete specifying information.  
 Specify all products by their product code.

**Pricing Effective: January 2023**



# MASS STACKING COUNTER CHAIR, UPHOLSTERED SEAT

Design: ITEMdesignworks, licensed by Sellex

# MA10



### PRICING FOR QUANTITIES 1-99

#### Mass Stacking Counter Chair

MODEL	LIST PRICE/GRADE	COM/COL	A	B	C	D	E	F	G	H	I	J	K	L
MASCU	Powder Coat	\$781	816	849	883	917	950	984	1017	1051	1085	1118	1152	1185
	Chrome	\$845	879	912	946	980	1013	1047	1080	1114	1148	1181	1215	1250

W 21.75 D 20.5 H 40.75 SH 25

COM Yardage: 1-3 seats: .5 yard  
 Contact Leland Customer Experience for yardage requirements on textiles with repeats.  
 For COL requirements please contact Leland Customer Experience.



### PRICING FOR QUANTITIES 100-299

#### Mass Stacking Counter Chair

MODEL	LIST PRICE/GRADE	COM/COL	A	B	C	D	E	F	G	H	I	J	K	L
MASCU	Powder Coat	\$737	771	804	838	873	906	940	973	1007	1041	1074	1108	1142
	Chrome	\$799	833	866	900	933	967	1001	1034	1069	1103	1136	1170	1203

W 21.75 D 20.5 H 40.75 SH 25

COM Yardage: 1-3 seats: .5 yard  
 Contact Leland Customer Experience for yardage requirements on textiles with repeats.  
 For COL requirements please contact Leland Customer Experience.



### PRICING FOR QUANTITIES 300+

#### Mass Stacking Counter Chair

MODEL	LIST PRICE/GRADE	COM/COL	A	B	C	D	E	F	G	H	I	J	K	L
MASCU	Powder Coat	\$695	729	762	796	830	863	897	930	964	998	1032	1066	1099
	Chrome	\$751	784	818	852	886	920	953	987	1021	1055	1089	1122	1156

W 21.75 D 20.5 H 40.75 SH 25

COM Yardage: 1-3 seats: .5 yard  
 Contact Leland Customer Experience for yardage requirements on textiles with repeats.  
 For COL requirements please contact Leland Customer Experience.

To specify:

Please refer to pages 3-4 for complete specifying information.  
 Specify all products by their product code.

Pricing Effective: January 2023

**MASS STACKING BAR CHAIR**  
 Design: ITEMdesignworks, licensed by Sellex

**MA11**



**PRICING FOR QUANTITIES 1-99**

<b>Mass Stacking Bar Chair</b>	<b>MODEL</b>	<b>FRAME FINISH</b>	<b>LIST PRICE</b>
Polypropylene shell	MASB	Powder Coat	\$671
W 21.75 D 20.5 H 40.75 SH 29		Chrome	\$736



**PRICING FOR QUANTITIES 100-299**

<b>Mass Stacking Bar Chair</b>	<b>MODEL</b>	<b>FRAME FINISH</b>	<b>LIST PRICE</b>
Polypropylene shell	MASB	Powder Coat	\$634
W 21.75 D 20.5 H 40.75 SH 29		Chrome	\$696



**PRICING FOR QUANTITIES 300+**

<b>Mass Stacking Bar Chair</b>	<b>MODEL</b>	<b>FRAME FINISH</b>	<b>LIST PRICE</b>
Polypropylene shell	MASB	Powder Coat	\$597
W 21.75 D 20.5 H 40.75 SH 29		Chrome	\$635

**To specify:**  
 Please refer to pages 3-4 for complete specifying information.  
 Specify all products by their product code.

**Pricing Effective: January 2023**

**MASS STACKING BAR CHAIR, UPHOLSTERED SEAT**  
 Design: ITEMdesignworks, licensed by Sellex

**MA12**



**PRICING FOR QUANTITIES 1-99**

**Mass Stacking Bar Chair**

MODEL	LIST PRICE/GRADE	COM/COL	A	B	C	D	E	F	G	H	I	J	K	L
MASBU	Powder Coat	\$806	841	876	910	945	980	1014	1049	1084	1118	1153	1189	1223
	Chrome	\$870	906	941	975	1010	1045	1079	1114	1149	1183	1218	1253	1288

W 21.75 D 20.5 H 40.75 SH 29

COM Yardage: 1-3 seats: .5 yard  
 Contact Leland Customer Experience for yardage requirements on textiles with repeats.  
 For COL requirements please contact Leland Customer Experience.

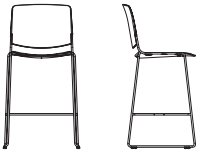

**PRICING FOR QUANTITIES 100-299**

**Mass Stacking Bar Chair**

MODEL	LIST PRICE/GRADE	COM/COL	A	B	C	D	E	F	G	H	I	J	K	L
MASBU	Powder Coat	\$760	795	830	864	899	933	968	1003	1038	1073	1108	1142	1177
	Chrome	\$824	859	894	928	963	998	1032	1067	1101	1136	1172	1206	1241

W 21.75 D 20.5 H 40.75 SH 29

COM Yardage: 1-3 seats: .5 yard  
 Contact Leland Customer Experience for yardage requirements on textiles with repeats.  
 For COL requirements please contact Leland Customer Experience.

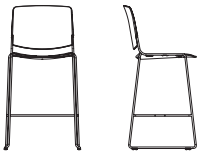

**PRICING FOR QUANTITIES 300+**

**Mass Stacking Bar Chair**

MODEL	LIST PRICE/GRADE	COM/COL	A	B	C	D	E	F	G	H	I	J	K	L
MASBU	Powder Coat	\$716	751	785	820	856	890	925	960	994	1029	1064	1098	1133
	Chrome	\$775	810	844	879	914	948	983	1017	1052	1087	1122	1157	1192

W 21.75 D 20.5 H 40.75 SH 29

COM Yardage: 1-3 seats: .5 yard  
 Contact Leland Customer Experience for yardage requirements on textiles with repeats.  
 For COL requirements please contact Leland Customer Experience.

**To specify:**  
 Please refer to pages 3-4 for complete specifying information.  
 Specify all products by their product code.

**Pricing Effective: January 2023**

**MASS TRANSPORT/STACKING DOLLY**  
 Design: ITEMdesignworks, licensed by Sellex

**MA13**



Mass Transport/Stacking Dolly	MODEL	FRAME FINISH	LIST PRICE
Black powder coat finish	MASD		\$1006
W 34.5 D 23 H 17 (Dimensions of dolly when empty)		Mass Transport/Stacking Dolly capacity: 40 high (15 high on floor) Weight with 40 high on dolly: 565 lbs For use with Side and Arm Chair models (including upholstered)	
W 41.25 D 23 H 65.25 (Dimensions with 40 poly chair stack)		**Bar and Counter models do not stack on dolly	

**MASS AUXILIARY OPTIONS**  
 Design: ITEMdesignworks, licensed by Sellex



Ganging Device	MODEL	LIST PRICE
two per set	GD	\$53

Available for all models \*\*Only comes in recycled black

**To specify:**  
 Please refer to pages 3-4 for complete specifying information.  
 Specify all products by their product code.

**Pricing Effective: January 2023**

---

**5695 Eagle Drive, SE  
Grand Rapids,  
Michigan 49512  
616-975-9260  
lelandfurniture.com**

# Omena

## January 2023 Price List



# Omena

Table of Contents	OM2
Specification Information	OM3
Specification Example	OM4
Side Chair	OM5
Counter Stool	OM7
Bar Stool	OM8
Low Stool	OM9

## Chair Model

DESCRIPTION	CODE
Omena side chair	OMSW
Omena side chair, upholstered seat	OMSWU
Omena side chair, upholstered seat and back	OMSWUU
Omena counter stool	OMCW
Omena counter stool, upholstered seat	OMCWU
Omena bar stool	OMBW
Omena bar stool, upholstered seat	OMBWU
Omena low stool	OMLW
Omena low stool, upholstered seat	OMLWU

## Shell Veneer

DESCRIPTION	CODE
Maple (standard)	M
Oak (premium)	O

## Shell Leg/Finish

### STANDARD SHELL/LEG (MAPLE):

### STANDARD LELAND COLORS

### CUSTOM SPECIFY Custom (01)

### OAK SHELL/BASE:

DESCRIPTION	CODE
Morel	66M
Weathered	68M
Dune	69M
Trillium	70M

### GRADIENT FINISHES

DESCRIPTION	CODE
Blue Sky Gradient BG	90MG
Forest Gradient FG	86MG
Gravel Gradient GG	87MG
Dawn Gradient DG	88MG
Heather Gradient HG	99MG

Gradient Finishes applied on maple shell/leg only and are only offered on Omena side chair and low stool.

## Upholstery Selection

Please refer to Leland Textile Program which features textiles and leathers from the following partners:

- Camira
- Green Hides
- Carnegie
- Maharam
- CF Stinson
- Unika Vaev

The complete grade list can be found on our website or you can specify COM/COL. Due to the design of this product, it is recommended that all non pre-approved textile be tested for compatibility.

## Glide Type

### STANDARD:

DESCRIPTION	CODE
Nylon	S

### OPTIONAL:

Please note that optional glides raise the chair height .5 inch.

DESCRIPTION	CODE
Rubber	R
Felt	FC

## Stacking note

The Omena chair/stool does not stack.



## Specifications required to create the product code

- Model
- Wood Species
- Shell Finish
- Seat Upholstery Selection (when applicable)
- Leg Finish
- Back Upholstery Selection (when applicable)
- Glide Type

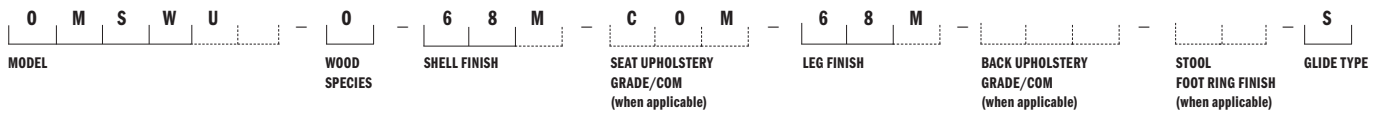

### MODEL

Omena Side Chair, Upholstered Seat (OMSWU)

### WOOD SPECIES

Oak (O)

### SHELL FINISH

Weathered (68M)

### SEAT UPHOLSTERY SELECTION

When applicable, enter upholstery grade, COM

### LEG FINISH

Weathered (68M)

### BACK UPHOLSTERY SELECTION

When applicable, enter upholstery grade, COM



OMENA SIDE CHAIR  
Design: 2B Studio, Will Oltman

OM5



Omena Side Chair	MODEL	LIST PRICE
Maple shell/base	OMSW-M	\$809
W 17.5 D 21 H 31 SH 18		Optional Glides: Add \$8.00 net per chair for a set of four (4). Optional Glides raise chair height .5 inch. Gradient Finishes Upcharge: \$168 List



Omena Side Chair	MODEL	LIST PRICE/GRADE	COM/COL	A	B	C	D	E	F	G	H	I	J	K	L
Maple shell/base, upholstered seat	OMSWU-M	\$949	991	1012	1033	1055	1076	1097	1118	1140	1161	1182	1203	1225	
W 17.5 D 21 H 31 SH 18.5		Optional Glides: Add \$8.00 net per chair for a set of four (4). Optional Glides raise chair height .5 inch. Gradient Finishes Upcharge: \$168 List COM Yardage: 0.5 yards, 1-2 seats Contact Leland Customer Experience for yardage requirements on textiles with repeats. For COL requirements please contact Leland Customer Experience.													



Omena Side Chair	MODEL	LIST PRICE/ GRADE	COM/COL	A	B	C	D	E	F	G	H	I	J	K	L
Maple shell/base, upholstered seat and back	OMSWUU-M	\$1091	1174	1216	1259	1301	1344	1386	1429	1472	1514	1557	1599	1642	
W 17.5 D 21 H 31 SH 18.5		Optional Glides: Add \$8.00 net per chair for a set of four (4). Optional Glides raise chair height .5 inch. Gradient Finishes Upcharge: \$168 List 1 yard, 1-2 seat and backs Contact Leland Customer Experience for yardage requirements on textiles with repeats. For COL requirements please contact Leland Customer Experience.													

To specify:  
Please refer to pages 3-4 for complete specifying information.  
Specify all products by their product code.

Pricing Effective: January 2023

OMENA SIDE CHAIR  
Design: 2B Studio, Will Oltman

# OM6



Omena Side Chair	MODEL	LIST PRICE
Oak shell/base	OMSW-0	\$900
W 17.5 D 21 H 31 SH 18	Optional Glides: Add \$8.00 net per chair for a set of four (4). Optional Glides raise chair height .5 inch.	



Omena Side Chair	MODEL	LIST PRICE/GRADE	COM/COL	A	B	C	D	E	F	G	H	I	J	K	L
Oak shell/base, upholstered seat	OMSWU-0		\$1042	1083	1104	1126	1147	1168	1190	1211	1232	1253	1275	1296	1317
W 17.5 D 21 H 31 SH 18.5	Optional Glides: Add \$8.00 net per chair for a set of four (4). Optional Glides raise chair height .5 inch. COM Yardage: 0.5 yards, 1-2 seats Contact Leland Customer Experience for yardage requirements on textiles with repeats. For COL requirements please contact Leland Customer Experience.														



Omena Side Chair	MODEL	LIST PRICE/GRADE	COM/COL	A	B	C	D	E	F	G	H	I	J	K	L
Oak shell/base, upholstered seat and back	OMSWUU-0		\$1182	1265	1308	1350	1393	1435	1478	1521	1563	1607	1649	1692	1734
W 17.5 D 21 H 31 SH 18.5	Optional Glides: Add \$8.00 net per chair for a set of four (4). Optional Glides raise chair height .5 inch. 1 yard, 1-2 seat and backs Contact Leland Customer Experience for yardage requirements on textiles with repeats. For COL requirements please contact Leland Customer Experience.														

To specify:  
Please refer to pages 3-4 for complete specifying information.  
Specify all products by their product code.

Pricing Effective: January 2023

OMENA COUNTER STOOL  
Design: 2B Studio, Will Oltman

OM7



**Omena Counter Stool**

MODEL

LIST PRICE

Maple shell

OMCW-M

\$1294

W 17.5 D 21 H 25 SH 24

Optional Glides: Add \$8.00 net per chair for a set of four (4). Optional Glides raise chair height .5 inch.



**Omena Counter Stool**

MODEL

LIST PRICE/  
GRADE

COM/COL

A

B

C

D

E

F

G

H

I

J

K

L

Maple shell,  
upholstered seat

OMCWU-M

\$1413

1455

1476

1497

1518

1540

1561

1582

1604

1625

1646

1667

1689

W 17.5 D 21 H 25.75 SH 24.75

Optional Glides: Add \$8.00 net per chair for a set of four (4). Optional Glides raise chair height .5 inch.  
COM yardage: 0.75 yards for 1-2 seats  
Contact Leland Customer Experience for yardage requirements on textiles with repeats.  
For COL requirements please contact Leland Customer Experience.



**Omena Counter Stool**

MODEL

LIST PRICE

Oak shell

OMCW-O

\$1448

W 17.5 D 21 H 25 SH 24

Optional Glides: Add \$8.00 net per chair for a set of four (4). Optional Glides raise chair height .5 inch.



**Omena Counter Stool**

MODEL

LIST PRICE/  
GRADE

COM/COL

A

B

C

D

E

F

G

H

I

J

K

L

Oak shell,  
upholstered seat

OMCWU-O

\$1570

1611

1632

1654

1675

1696

1717

1739

1760

1781

1803

1824

1845

W 17.5 D 21 H 25.75 SH 24.75

Optional Glides: Add \$8.00 net per chair for a set of four (4). Optional Glides raise chair height .5 inch.  
COM yardage: 0.75 yards for 1-2 seats  
Contact Leland Customer Experience for yardage requirements on textiles with repeats.  
For COL requirements please contact Leland Customer Experience.

To specify:

Please refer to pages 3-4 for complete specifying information. Specify all products by their product code.

Pricing Effective: January 2023

OMENA BAR STOOL  
Design: 2B Studio, Will Oltman

OM8



**Omena Bar Stool**

MODEL

LIST PRICE

Maple shell

OMBW-M

\$1521

W 17.5 D 21 H 31 SH 30

Optional Glides: Add \$8.00 net per chair for a set of four (4). Optional Glides raise chair height .5 inch.



**Omena Bar Stool**

MODEL

LIST PRICE/  
GRADE

COM/COL

A

B

C

D

E

F

G

H

I

J

K

L

Maple shell/base,  
upholstered seat

OMBWU-M

\$1662

1704

1725

1746

1767

1789

1810

1831

1853

1874

1895

1916

1938

W 17.5 D 21 H 31.75 SH 30.75

Optional Glides: Add \$8.00 net per chair for a set of four (4). Optional Glides raise chair height .5 inch.  
COM yardage: 0.75 yards for 1-2 seats  
Contact Leland Customer Experience for yardage requirements on textiles with repeats.  
For COL requirements please contact Leland Customer Experience.



**Omena Bar Stool**

MODEL

LIST PRICE

Oak shell

OMBW-O

\$1704

W 17.5 D 21 H 31 SH 30

Optional Glides: Add \$8.00 net per chair for a set of four (4). Optional Glides raise chair height .5 inch.



**Omena Bar Stool**

MODEL

LIST PRICE/  
GRADE

COM/COL

A

B

C

D

E

F

G

H

I

J

K

L

Oak shell,  
upholstered seat

OMBWU-O

\$1845

1887

1908

1929

1950

1972

1993

2014

2036

2057

2078

2099

2121

W 17.5 D 21 H 31.75 SH 30.75

Optional Glides: Add \$8.00 net per chair for a set of four (4). Optional Glides raise chair height .5 inch.  
COM yardage: 0.75 yards for 1-2 seats  
Contact Leland Customer Experience for yardage requirements on textiles with repeats.  
For COL requirements please contact Leland Customer Experience.

To specify:

Please refer to pages 3-4 for complete specifying information. Specify all products by their product code.

Pricing Effective: January 2023

**OMENA BAR STOOL**  
Design: 2B Studio, Will Oltman

**OM9**



**Omena Low Stool**

**MODEL**

**LIST PRICE**

Maple shell

OMLW-M

\$1238

W 16.5 D 12.09 H 19 SH 18

Optional Glides: Add \$8.00 net per chair for a set of four (4). Optional Glides raise chair height .5 inch.  
Gradient Finishes Upcharge: \$168 List



**Omena Low Stool**

**MODEL**

**LIST PRICE/  
GRADE**

**COM/COL**

**A**

**B**

**C**

**D**

**E**

**F**

**G**

**H**

**I**

**J**

**K**

**L**

Maple shell/base,  
upholstered seat

OMLWU-M

\$1358

1399

1421

1442

1463

1484

1506

1527

1548

1570

1591

1612

1633

W 17.83 D 13.53 H 19.75  
SH 18.75

Optional Glides: Add \$8.00 net per chair for a set of four (4). Optional Glides raise chair height .5 inch.  
Gradient Finishes Upcharge: \$168 List  
COM yardage: 0.5 yards, 1-2 seats  
Contact Leland Customer Experience for yardage requirements on textiles with repeats.  
For COL requirements please contact Leland Customer Experience.



**Omena Low Stool**

**MODEL**

**LIST PRICE**

Oak shell

OMLW-O

\$1392

W 16.5 D 12.09 H 19 SH 18

Optional Glides: Add \$8.00 net per chair for a set of four (4). Optional Glides raise chair height .5 inch.



**Omena Low Stool**

**MODEL**

**LIST PRICE/  
GRADE**

**COM/COL**

**A**

**B**

**C**

**D**

**E**

**F**

**G**

**H**

**I**

**J**

**K**

**L**

Oak shell,  
upholstered seat

OMLWU-O

\$1513

1555

1576

1597

1618

1640

1661

1682

1704

1725

1746

1767

1789

W 17.83 D 13.53 H 19.75  
SH 18.75

Optional Glides: Add \$8.00 net per chair for a set of four (4). Optional Glides raise chair height .5 inch.  
COM yardage: 0.5 yards, 1-2 seats  
Contact Leland Customer Experience for yardage requirements on textiles with repeats.  
For COL requirements please contact Leland Customer Experience.

**To specify:**

**Please refer to pages 3-4 for complete specifying information. Specify all products by their product code.**

**Pricing Effective: January 2023**

---

**5695 Eagle Drive, SE  
Grand Rapids,  
Michigan 49512  
616-975-9260  
lelandfurniture.com**

# Parfait II

## January 2023 Price List





# Parfait II

Table of Contents	PII2
Specification Information	PII3
Specification Example	PII4
Stacking Side Chair	PII5
Non-Stacking Side Chair	PII6
Mobile Stacking Side Chair	PII7
Mobile Non-Stacking Side Chair	PII9
Arm Chair	PII11
Mobile Arm Chair	PII12
Counter Chair	PII14
Bar Chair	PII15
Transport/Stacking Dolly	PII16

**Chair Model**

**STACKING SIDE CHAIR:**

DESCRIPTION	CODE
upholstered seat, wood back	PSSUW
wood seat, wood back	PSSWW
upholstered seat, wood back, upholstered back onlay	PSSUWU

**SIDE CHAIR:**

DESCRIPTION	CODE
upholstered seat, wood back	PSUW
wood seat, wood back	PSWW
upholstered seat, wood back, upholstered back onlay	PSUWU

**ARM CHAIR:**

DESCRIPTION	CODE
upholstered seat, wood back, polypropylene arm cap	PAUW
wood seat, wood back, polypropylene arm cap	PAWW
upholstered seat, wood back	
upholstered back onlay, polypropylene arm cap	PAUWU-P
upholstered seat, wood back	
upholstered back onlay, upholstered arm cap	PAUWU-U

**COUNTER CHAIR:**

DESCRIPTION	CODE
upholstered seat, wood back	PCUW
wood seat, wood back	PCWW
upholstered seat, wood back, upholstered back onlay	PCUWU

**BAR CHAIR:**

DESCRIPTION	CODE
upholstered seat, wood back	PBUW
wood seat, wood back	PBWW
upholstered seat, wood seat, upholstered back onlay	PBUWU

**MOBILE STACKING SIDE CHAIR:**

DESCRIPTION	CODE
upholstered seat, wood back	PMSSUW
wood seat, wood back	PMSSWW
upholstered seat, wood back, upholstered back onlay	PMSSUWU

**MOBILE SIDE CHAIR (NON-STACKING):**

DESCRIPTION	CODE
upholstered seat, wood back	PMSUW
wood seat, wood back	PMSWW
upholstered seat, wood back	PMSUWU

**MOBILE ARM CHAIR (NON-STACKING):**

DESCRIPTION	CODE
upholstered seat, wood back, polypropylene arm cap	PMAUW
wood seat, wood back, polypropylene arm cap	PMAWW
upholstered seat, wood back,	
upholstered back onlay, polypropylene arm cap	PMAUWU-P
upholstered seat, wood back,	
upholstered back onlay, upholstered arm cap	PMAUWU-U

**Upholstery Selection**

Please refer to Leland Textile Program which features textiles and leathers from the following partners:

- Camira
- Green Hides
- Carnegie
- Maharam
- CF Stinson
- Unika Vaev

The complete grade list can be found on our website or you can specify COM/COL. Due to the design of this product, it is recommended that all non pre-approved textile be tested for compatibility.

**Pricing Effective: January 2023**

**Seat and Back Wood Finish**

**STANDARD LELAND COLORS**

**CUSTOM SPECIFY** Custom (01)

\*Please note that Parfait II is NOT AVAILABLE in the following finishes:  
Natural Walnut Matte (08M), Natural Beech (09), Natural White Oak Matte (12M)

**Frame Finish**

DESCRIPTION	CODE	DESCRIPTION	CODE
Sterling	ST	Matte Mercury	MMR
Warm Grey	WG	Matte Mineral	MMN
Cool Grey	CG	Matte Burnish	MBN
Black	B	Matte Foundry	MFN
White	W	Matte Forest	MFO
Matte Blue Sky	MBS	Matte Willow	MWL
Matte Sienna	MSN		

TEXTURED	CODE	TEXTURED	CODE
Dolphin Textured	DLT	Oxford Textured	OXT
Grey Textured	GT	Black Textured	BT
White Textured	WT		

**Arm Cap Type**

DESCRIPTION	CODE
Polypropylene	P
Upholstered	U

**Arm Cap Color (Polypropylene)**

DESCRIPTION	CODE
Black	B
Silver	S

**Glide Type or Caster Type for Mobile Chairs**

**STANDARD:**

DESCRIPTION	CODE
Nylon	S

**OPTIONAL:**

DESCRIPTION	CODE
Felt	FC
Floor Saver™ (for VCT type floors)	FS
Metal	M
Rubber	R

Please note that optional glides raise the chair height .5 inch.

**CASTER TYPE:**

DESCRIPTION	CODE
Hard floor caster	HF
Soft floor caster	SF

**Specifications required to create the product code**

- Model
- Seat Upholstery or Finish
- Back Finish
- Upholstered Back Onlay (when applicable)
- Frame Finish
- Arm Cap Type (when applicable)
- Arm Cap Color or Upholstery (when applicable)
- Glide or Caster Type



**MODEL**

Parfait II Side Chair -  
wood seat, wood back (PSWW)

**SEAT UPHOLSTERY OR FINISH**

Natural (11)

**BACK FINISH**

Natural (11)

**UPHOLSTERED BACK ONLAY**

When applicable, enter upholstery grade, COM or COL



**FRAME FINISH**

Sterling (ST)

**ARM CAP TYPE**

When applicable, enter arm cap type code

**ARM CAP COLOR OR UPHOLSTERY**

When applicable, enter color, upholstery grade, COM or COL



**PARFAIT II STACKING SIDE CHAIR**  
 Design: Bruce Sienkowski

**PII5**



**Parfait II**

**Stacking Side Chair**

	MODEL	LIST PRICE/GRADE	COM/COL	A	B	C	D	E	F	G	H	I	J	K	L
Upholstered seat, wood back	PSSUW		\$686	717	734	753	770	788	804	822	839	857	875	893	909

W 20.25 D 21.5 H 32.5 SH 19

Optional Glides: Add \$8.00 net per chair for a set of four (4). Optional Glides raise chair height .5 inch.  
 COM Yardage: 1 or 2 seats: .75 yard; 3 or 4 seats: 1.5 yards; 5 or 6 seats: 2.25 yards  
 Contact Leland Customer Experience for yardage requirements on textiles with repeats.  
 For COL requirements please contact Leland Customer Experience.



**Parfait II**

**Stacking Side Chair**

	MODEL	LIST PRICE
Wood seat, wood back	PSSWW	\$717

W 20.25 D 21.5 H 32.5 SH 18.5

Optional Glides: Add \$8.00 net per chair for a set of four (4). Optional Glides raise chair height .5 inch.



**Parfait II**

**Stacking Side Chair**

	MODEL	LIST PRICE/ GRADE	COM/COL	A	B	C	D	E	F	G	H	I	J	K	L
Upholstered seat, wood back upholstered seat and back	PSSUWU	\$773		821	846	870	896	921	946	971	995	1021	1046	1070	1095

W 20.25 D 21.5 H 32.5 SH 19

Optional Glides: Add \$8.00 net per chair for a set of four (4). Optional Glides raise chair height .5 inch.  
 COM Yardage: 1 seat and back: .75 yard, 6 seats and backs: 3.5 yards  
 Contact Leland Customer Experience for yardage requirements on textiles with repeats.  
 For COL requirements please contact Leland Customer Experience.

**To specify:**  
 Please refer to pages 3-5 for complete specifying information.  
 Specify all products by their product code.

**Pricing Effective: January 2023**

**PARFAIT II NON-STACKING SIDE CHAIR**  
 Design: Bruce Sienkowski

**PII6**



**Parfait II**

**Non-Stacking Side Chair**

	MODEL	LIST PRICE/GRADE	COM/COL	A	B	C	D	E	F	G	H	I	J	K	L
Upholstered seat, wood back	PSUW		\$618	650	668	685	702	719	738	755	773	790	807	824	842

W 20.25 D 21.5 H 32.5 SH 19

Optional Glides: Add \$8.00 net per chair for a set of four (4). Optional Glides raise chair height .5 inch.  
 COM Yardage: 1 or 2 seats: .75 yard; 3 or 4 seats: 1.5 yards; 5 or 6 seats: 2.25 yards  
 Contact Leland Customer Experience for yardage requirements on textiles with repeats.  
 For COL requirements please contact Leland Customer Experience.



**Parfait II**

**Non-Stacking Side Chair**

	MODEL	LIST PRICE
Wood seat, wood back	PSWW	\$653

W 20.5 D 21.5 H 32.5 SH 18.5

Optional Glides: Add \$8.00 net per chair for a set of four (4). Optional Glides raise chair height .5 inch.



**Parfait II**

**Non-Stacking Side Chair**

	MODEL	LIST PRICE/ GRADE	COM/COL	A	B	C	D	E	F	G	H	I	J	K	L
Upholstered seat, wood back upholstered seat and back	PSUWU		\$726	774	799	823	848	873	898	924	948	973	999	1023	1048

W 20.5 D 21.5 H 32.5 SH 19

Optional Glides: Add \$8.00 net per chair for a set of four (4). Optional Glides raise chair height .5 inch.  
 COM Yardage: 1 seat and back: .75 yard, 6 seats and backs: 3.5 yards  
 Contact Leland Customer Experience for yardage requirements on textiles with repeats.  
 For COL requirements please contact Leland Customer Experience.

To specify:

Please refer to pages 3-5 for complete specifying information.  
 Specify all products by their product code.

Pricing Effective: January 2023

PARFAIT II MOBILE STACKING SIDE CHAIR  
 Design: Bruce Sienkowski

PII7

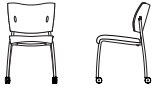

**Parfait II Mobile  
 Stacking Side Chair**

	MODEL	LIST PRICE/GRADE	COM/COL	A	B	C	D	E	F	G	H	I	J	K	L
Upholstered seat, wood back hard floor caster	PMSSUW-HF		\$826	858	877	894	911	928	946	963	980	999	1016	1033	1051

COM Yardage: 1 or 2 seats: .75 yard; 3 or 4 seats: 1.5 yards; 5 or 6 seats: 2.25 yards  
 Contact Leland Customer Experience for yardage requirements on textiles with repeats.  
 For COL requirements please contact Leland Customer Experience.

W 20.25 D 21.5 H 32.5 SH 19

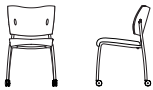

**Parfait II Mobile  
 Stacking Side Chair**

	MODEL	LIST PRICE/ GRADE	COM/COL	A	B	C	D	E	F	G	H	I	J	K	L
Upholstered seat, wood back soft floor caster	PMSSUW-SF		\$826	858	877	894	911	928	946	963	980	999	1016	1033	1051

COM Yardage: 1 or 2 seats: .75 yard; 3 or 4 seats: 1.5 yards; 5 or 6 seats: 2.25 yards  
 Contact Leland Customer Experience for yardage requirements on textiles with repeats.  
 For COL requirements please contact Leland Customer Experience.

W 20.5 D 21.5 H 32.5 SH 19

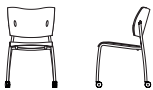

**Parfait II Mobile  
 Stacking Side Chair**

	MODEL	LIST PRICE
Wood seat, wood back hard floor caster	PMSSWW-HF	\$867

W 20.5 D 21.5 H 32.5 SH 18.5



**Parfait II Mobile  
 Stacking Side Chair**

	MODEL	LIST PRICE
Wood seat, wood back soft floor caster	PMSSWW-SF	\$867

W 20.5 D 21.5 H 32.5 SH 18.5

**To specify:**  
 Please refer to pages 3-5 for  
 complete specifying information.  
 Specify all products by their  
 product code.

# PARFAIT II MOBILE STACKING SIDE CHAIR

Design: Bruce Sienkowski

# PII8

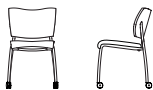

## Parfait II Mobile Stacking Side Chair

	MODEL	LIST PRICE/GRADE	COM/COL	A	B	C	D	E	F	G	H	I	J	K	L
Upholstered seat, wood back upholstered back onlay, hard floor caster	PMSSUWU-HF	\$914		962	987	1012	1036	1063	1087	1112	1137	1161	1187	1213	1237
W 20.25 D 21.5 H 32.5 SH 19															

COM Yardage: 1 seat and back: .75 yard, 6 seats and backs: 3.5 yard  
Contact Leland Customer Experience for yardage requirements on textiles with repeats.  
For COL requirements please contact Leland Customer Experience.

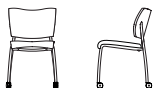

## Parfait II Mobile Stacking Side Chair

	MODEL	LIST PRICE/GRADE	COM/COL	A	B	C	D	E	F	G	H	I	J	K	L
Upholstered seat, wood back upholstered back onlay, soft floor caster	PMSSUWU-SF	\$914		962	987	1012	1036	1063	1087	1112	1137	1161	1187	1213	1237
W 20.25 D 21.5 H 32.5 SH 19															

COM Yardage: 1 seat and back: .75 yard, 6 seats and backs: 3.5 yard  
Contact Leland Customer Experience for yardage requirements on textiles with repeats.  
For COL requirements please contact Leland Customer Experience.

To specify:

Please refer to pages 3-5 for  
complete specifying information.

Specify all products by their  
product code.

Pricing Effective: January 2023

# PARFAIT II MOBILE NON-STACKING SIDE CHAIR

Design: Bruce Sienkowski

# PII9

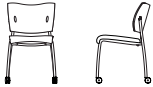

## Parfait II Mobile

### Non-Stacking Side Chair

	MODEL	LIST PRICE/GRADE	COM/COL	A	B	C	D	E	F	G	H	I	J	K	L
Upholstered seat, wood back, hard floor caster	PMSUW-HF		\$755	786	803	821	838	856	873	891	908	926	943	961	978

W 20.25 D 21.5 H 32.5 SH 19

COM Yardage: 1 or 2 seats: .75 yard; 3 or 4 seats: 1.5 yards; 5 or 6 seats: 2.25 yards  
Contact Leland Customer Experience for yardage requirements on textiles with repeats.  
For COL requirements please contact Leland Customer Experience.

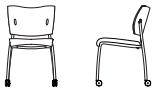

## Parfait II Mobile

### Non-Stacking Side Chair

	MODEL	LIST PRICE/ GRADE	COM/COL	A	B	C	D	E	F	G	H	I	J	K	L
Upholstered seat, wood back, soft floor caster	PMSUW-SF		\$755	786	803	821	838	856	873	891	908	926	943	961	978

W 20.5 D 21.5 H 32.5 SH 19

COM Yardage: 1 or 2 chair seats and back onlays: .75 yard; 3 or 4 chair seats and back onlays: 1.5 yards;  
5 or 6 Chair seats and back onlays: 2.25 yards  
Contact Leland Customer Experience for yardage requirements on textiles with repeats.  
For COL requirements please contact Leland Customer Experience.

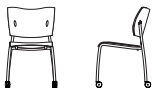

## Parfait II Mobile

### Non-Stacking Side Chair

	MODEL	LIST PRICE
Wood seat, wood back, hard floor caster	PMSWW-HF	\$796
W 20.5 D 21.5 H 32.5 SH 18.5		



## Parfait II Mobile

### Non-Stacking Side Chair

	MODEL	LIST PRICE
Wood seat, wood back soft floor caster	PMSWW-SF	\$796
W 20.5 D 21.5 H 32.5 SH 18.5		

To specify:

Please refer to pages 3-5 for complete specifying information.  
Specify all products by their product code.

Pricing Effective: January 2023



# PARFAIT II MOBILE NON-STACKING SIDE CHAIR

Design: Bruce Sienkowski

# PII10

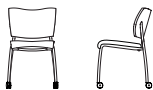

## Parfait II Mobile

### Non-Stacking Side Chair

	MODEL	LIST PRICE/GRADE	COM/COL	A	B	C	D	E	F	G	H	I	J	K	L
Upholstered seat, wood back upholstered back onlay, hard floor caster	PMSUWU-HF	\$867		916	941	965	990	1016	1041	1066	1091	1115	1140	1167	1191
W 20.25 D 21.5 H 32.5 SH 19															

COM Yardage: 1 seat and back: .75 yard, 6 seats and backs: 3.5 yards  
 Contact Leland Customer Experience for yardage requirements on textiles with repeats.  
 For COL requirements please contact Leland Customer Experience.

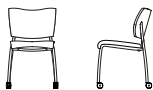

## Parfait II Mobile

### Non-Stacking Side Chair

	MODEL	LIST PRICE/GRADE	COM/COL	A	B	C	D	E	F	G	H	I	J	K	L
Upholstered seat, wood back upholstered back onlay, soft floor caster	PMSUWU-SF	\$867		916	941	965	990	1016	1041	1066	1091	1115	1140	1167	1191
W 20.25 D 21.5 H 32.5 SH 19															

COM Yardage: 1 seat and back: .75 yard, 6 seats and backs: 3.5 yards  
 Contact Leland Customer Experience for yardage requirements on textiles with repeats.  
 For COL requirements please contact Leland Customer Experience.

To specify:

Please refer to pages 3-5 for complete specifying information.

Specify all products by their product code.

Pricing Effective: January 2023

**PARFAIT II ARM CHAIR**  
Design: Bruce Sienkowski

**PII11**



**Parfait II Arm Chair**

	MODEL	LIST PRICE/GRADE	COM/COL	A	B	C	D	E	F	G	H	I	J	K	L
Upholstered seat, wood back	PAUW	\$867		898	916	932	951	969	986	1003	1021	1037	1055	1074	1091

W 25.5 D 21.5 H 32.5  
SH 19 AH 27

Optional Glides: Add \$8.00 net per chair for a set of four (4). Optional Glides raise chair height .5 inch.  
COM Yardage: 1 or 2 seats: .75 yard; 3 or 4 seats: 1.5 yards; 5 or 6 seats: 2.25 yards  
Contact Leland Customer Experience for yardage requirements on textiles with repeats.  
For COL requirements please contact Leland Customer Experience.



**Parfait II Arm Chair**

	MODEL	LIST PRICE
Wood seat, wood back	PAWW	\$898

W 25.5 D 21.5 H 32.5  
SH 18.5 AH 18.5

Optional Glides: Add \$8.00 net per chair for a set of four (4). Optional Glides raise chair height .5 inch.



**Parfait II Arm Chair**

	MODEL	LIST PRICE/GRADE	COM/COL	A	B	C	D	E	F	G	H	I	J	K	L
Upholstered seat, wood back Upholstered back onlay, polypropylene arm cap	PAUWU-P	\$932		983	1007	1032	1056	1082	1107	1132	1157	1182	1206	1232	1256

W 25.5 D 21.5 H 32.5  
SH 19 AH 27

Optional Glides: Add \$8.00 net per chair for a set of four (4). Optional Glides raise chair height .5 inch.  
COM Yardage: 1 seat and back: .75 yard, 6 seats and backs: 3.5 yards  
Contact Leland Customer Experience for yardage requirements on textiles with repeats.  
For COL requirements please contact Leland Customer Experience.



**Parfait II Arm Chair**

	MODEL	LIST PRICE/GRADE	COM/COL	A	B	C	D	E	F	G	H	I	J	K	L
Upholstered seat, wood back Upholstered back onlay, upholstered arm cap	PAUWU-U	\$984		1032	1056	1082	1107	1132	1157	1182	1206	1232	1256	1281	1307

W 25.5 D 21.5 H 32.5  
SH 19 AH 27

Optional Glides: Add \$8.00 net per chair for a set of four (4). Optional Glides raise chair height .5 inch.  
upholstered arm cap COM Yardage: 1 seat and back: .75 yard, 6 seats and backs: 3.5 yards,  
1 or 2 pairs arm caps:.25 yard  
Contact Leland Customer Experience for yardage requirements on textiles with repeats.  
For COL requirements please contact Leland Customer Experience..

**To specify:**  
Please refer to pages 3-5 for complete specifying information.  
Specify all products by their product code.

**Pricing Effective: January 2023**

PARFAIT II MOBILE ARM CHAIR  
Design: Bruce Sienkowski

PII12



Parfait II Mobile Arm Chair	MODEL	LIST PRICE/GRADE	COM/COL	A	B	C	D	E	F	G	H	I	J	K	L
Upholstered seat, wood back, polypropylene arm cap, hard floor caster	PMAUW-P-HF	\$1022		1053	1070	1088	1106	1124	1140	1158	1175	1193	1210	1229	1245
W 25.5 D 21.5 H 32.5 SH 19 AH 27		COM Yardage: 1 or 2 seats: .75 yard; 3 or 4 seats: 1.5 yards; 5 or 6 seats: 2.25 yards Contact Leland Customer Experience for yardage requirements on textiles with repeats. For COL requirements please contact Leland Customer Experience.													

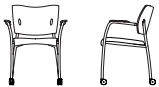

Parfait II Mobile Arm Chair	MODEL	LIST PRICE/GRADE	COM/COL	A	B	C	D	E	F	G	H	I	J	K	L
Upholstered seat, wood back, polypropylene arm cap, soft floor caster	PMAUW-P-SF	\$1022		1053	1070	1088	1106	1124	1140	1158	1175	1193	1210	1229	1245
W 25.5 D 21.5 H 32.5 SH 19 AH 27		COM Yardage: 1 or 2 chair seats and back onlays: .75 yard; 3 or 4 chair seats and back onlays: 1.5 yards; 5 to 6 Chair seats and back onlays: 2.25 yards Contact Leland Customer Experience for yardage requirements on textiles with repeats. For COL requirements please contact Leland Customer Experience.													



Parfait II Mobile Arm Chair	MODEL	LIST PRICE
Wood seat, wood back, polypropylene arm cap, hard floor caster	PMAWW-P-HF	\$1064
W 25.5 D 21.5 H 32.5 SH 18.5		



Parfait II Mobile Arm Chair	MODEL	LIST PRICE
Wood seat, wood back, polypropylene arm cap, soft floor caster	PMAWW-P-SF	\$1064
W 25.5 D 21.5 H 32.5 SH 18.5		

To specify:  
Please refer to pages 3-5 for complete specifying information.  
Specify all products by their product code.

Pricing Effective: January 2023

# PARFAIT II MOBILE ARM CHAIR

Design: Bruce Sienkowski

# PII13



## Parfait II Mobile Arm Chair

	MODEL	LIST PRICE/ GRADE	COM/COL	A	B	C	D	E	F	G	H	I	J	K	L
Upholstered seat, Upholstered back onlay, upholstered arm cap, hard floor caster	PMAUWU-U-HF		\$1135	1183	1208	1233	1258	1283	1308	1332	1358	1383	1407	1433	1458
W 25.5 D 21.5 H 32.5 SH 19 AH 27		COM Yardage: 1 seat and back: .75 yard, 6 seats and backs: 3.5 yards 2 pairs armcaps:.25 yard Contact Leland Customer Experience for yardage requirements on textiles with repeats. For COL requirements please contact Leland Customer Experience.													



## Parfait II Mobile Arm Chair

	MODEL	LIST PRICE/ GRADE	COM/COL	A	B	C	D	E	F	G	H	I	J	K	L
Upholstered seat, Upholstered back onlay, upholstered arm cap, soft floor caster	PMAUWU-U-SF		\$1135	1183	1208	1233	1258	1283	1308	1332	1358	1383	1407	1433	1458
W 25.5 D 21.5 H 32.5 SH 19 AH 27		COM Yardage: 1 seat and back: .75 yard, 6 seats and backs: 3.5 yards 2 pairs armcaps:.25 yard Contact Leland Customer Experience for yardage requirements on textiles with repeats. For COL requirements please contact Leland Customer Experience.													



## Parfait II Mobile Arm Chair

	MODEL	LIST PRICE/ GRADE	COM/COL	A	B	C	D	E	F	G	H	I	J	K	L
Upholstered seat, Upholstered back onlay, polypropylene arm cap, hard floor caster	PMAUWU-P-HF		\$1084	1133	1158	1183	1208	1233	1258	1283	1308	1332	1358	1383	1407
W 25.5 D 21.5 H 32.5 SH 19 AH 27		COM Yardage: 1 seat and back: .75 yard, 6 seats and backs: 3.5 yards Contact Leland Customer Experience for yardage requirements on textiles with repeats. For COL requirements please contact Leland Customer Experience.													



## Parfait II Mobile Arm Chair

	MODEL	LIST PRICE/ GRADE	COM/COL	A	B	C	D	E	F	G	H	I	J	K	L
Upholstered seat, Upholstered back onlay, polypropylene arm cap, soft floor caster	PMAUWU-P-SF		\$1084	1133	1158	1183	1208	1233	1258	1283	1308	1332	1358	1383	1407
W 25.5 D 21.5 H 32.5 SH 19 AH 27		COM Yardage: 1 seat and back: .75 yard, 6 seats and backs: 3.5 yards Contact Leland Customer Experience for yardage requirements on textiles with repeats. For COL requirements please contact Leland Customer Experience.													

To specify:

Please refer to pages 3-5 for complete specifying information. Specify all products by their product code.

Pricing Effective: January 2023

**PARFAIT II COUNTER CHAIR**  
 Design: Bruce Sienkowski

**PII14**



<b>Parfait II Counter Chair</b>	<b>MODEL</b>	<b>LIST PRICE/GRADE</b>	<b>COM/COL</b>	<b>A</b>	<b>B</b>	<b>C</b>	<b>D</b>	<b>E</b>	<b>F</b>	<b>G</b>	<b>H</b>	<b>I</b>	<b>J</b>	<b>K</b>	<b>L</b>
Upholstered seat, wood back	PCUW	\$860		891	908	926	943	961	978	995	1013	1031	1048	1066	1083

W 19.5 D 24 H 39 SH 25.5

Optional Glides: Add \$8.00 net per chair for a set of four (4). Optional Glides raise chair height .5 inch.  
 COM Yardage: 1 or 2 seats: .75 yard; 3 or 4 seats: 1.5 yards; 5 or 6 seats: 2.25 yards  
 Contact Leland Customer Experience for yardage requirements on textiles with repeats.  
 For COL requirements please contact Leland Customer Experience.



<b>Parfait II Counter Chair</b>	<b>MODEL</b>	<b>LIST PRICE</b>
Wood seat, wood back	PCWW	\$898

W 19.5 D 24 H 39 SH 25

Optional Glides: Add \$8.00 net per chair for a set of four (4). Optional Glides raise chair height .5 inch.



<b>Parfait II Counter Chair</b>	<b>MODEL</b>	<b>LIST PRICE/GRADE</b>	<b>COM/COL</b>	<b>A</b>	<b>B</b>	<b>C</b>	<b>D</b>	<b>E</b>	<b>F</b>	<b>G</b>	<b>H</b>	<b>I</b>	<b>J</b>	<b>K</b>	<b>L</b>
Upholstered seat, wood back upholstered back onlay	PCUWU	\$927		975	1001	1025	1051	1076	1100	1126	1151	1175	1201	1225	1251

W 19.5 D 24 H 39 SH 25.5

Optional Glides: Add \$8.00 net per chair for a set of four (4). Optional Glides raise chair height .5 inch.  
 COM Yardage: 1 seat and back: .75 yard, 6 seats and backs: 3.5 yards  
 Contact Leland Customer Experience for yardage requirements on textiles with repeats.  
 For COL requirements please contact Leland Customer Experience.

**To specify:**  
 Please refer to pages 3-5 for complete specifying information.  
 Specify all products by their product code.

**Pricing Effective: January 2023**

**PARFAIT II BAR CHAIR**  
Design: Bruce Sienkowski

**PII15**

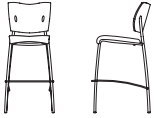

**Parfait II Bar Chair**

	MODEL	LIST PRICE/GRADE	COM/COL	A	B	C	D	E	F	G	H	I	J	K	L
Upholstered seat, wood back	PBUW	\$875		906	924	941	959	975	993	1010	1029	1046	1064	1080	1098

W 19.5 D 24 H 44 SH 31.5

Optional Glides: Add \$8.00 net per chair for a set of four (4). Optional Glides raise chair height .5 inch.  
Yardage: 1 or 2 seats: .75 yard; 3 or 4 seats: 1.5 yards; 5 or 6 seats: 2.25 yards  
Contact Leland Customer Experience for yardage requirements on textiles with repeats.  
For COL requirements please contact Leland Customer Experience.

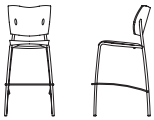

**Parfait II Bar Chair**

	MODEL	LIST PRICE
Wood seat, wood back	PBWW	\$916

W 19.5 D 24.5 H 44 SH 31

Optional Glides: Add \$8.00 net per chair for a set of four (4). Optional Glides raise chair height .5 inch.

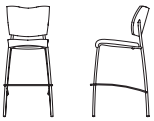

**Parfait II Bar Chair**

	MODEL	LIST PRICE/GRADE	COM/COL	A	B	C	D	E	F	G	H	I	J	K	L
Upholstered seat, wood back, upholstered back onlay	PBUWU	\$940		988	1013	1037	1064	1088	1113	1138	1162	1188	1214	1238	1263

W 19.5 D 24 H 44 SH 31.5

Optional Glides: Add \$8.00 net per chair for a set of four (4). Optional Glides raise chair height .5 inch.  
COM Yardage: 1 seat and back: .75 yard, 6 seats and backs: 3.5 yards  
Contact Leland Customer Experience for yardage requirements on textiles with repeats.  
For COL requirements please contact Leland Customer Experience.

**To specify:**  
Please refer to pages 3-5 for complete specifying information.  
Specify all products by their product code.

**Pricing Effective: January 2023**

PARFAIT II TRANSPORT/STACKING DOLLY  
 Design: Bruce Sienkowski

PII16

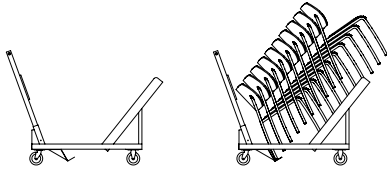

**Parfait II Transport/  
 Stacking Dolly**

**MODEL**

**LIST PRICE**

PSSD

Black Finish

\$989

W 25 D 57 H 44 (empty)

With 10 stacking chairs:  
 W 25 D 68 H 63

Parfait II Transport/Stacking Dolly handles up to 10 Parfait II stacking side chairs.

Please note that only the stacking version of the side chair will stack on the floor or Transport/Stacking Dolly.

**To specify:**

**Please refer to pages 3-5 for  
 complete specifying information.**

**Specify all products by their  
 product code.**

**Pricing Effective: January 2023**

---

**5695 Eagle Drive, SE  
Grand Rapids,  
Michigan 49512  
616-975-9260  
lelandfurniture.com**



# Pluto

## January 2023 Price List



# Pluto

Table of Contents	PB2
Specification Information	PB3
Specification Example	PB4
Bench	PB5
Auxiliary Option	PB6

**Bench Model**

DESCRIPTION	CODE
Pluto	PT

**Upholstery Selection**

Please refer to Leland Textile Program which features textiles from the following partners:

- Camira
- Carnegie
- CF Stinson
- Green Hides
- Maharam
- Unika Vaev

The complete grade list can be found on our website or you can specify COM/COL. Due to the design of this product, it is recommended that all non pre-approved textile be tested for compatibility.

**Upholstery Requirements**

With a choice of textile combinations, Pluto encourages design creativity. Please note that requirements vary by combination. The graded price of the combined yardage will be calculated using the highest grade textile selected.

TEXTILE REQUIREMENTS	YARDAGE
One textile, entire bench:	3.25 yards
Two/Three textile combination	
Seat:	1 yard
Top:	1 yard
Side:	1.25 yards

**Plinth Finish: Powdercoat and Chrome**

DESCRIPTION	CODE
Sterling	ST
Warm Grey	WG
Cool Grey	CG
Black	B
White	W
Matte Mercury	MMR
Matte Mineral	MMN
Matte Burnish	MBN
Matte Foundry	MFN
Brushed Chrome	BC

**Auxiliary Options**

Floor mount must be specified at the time of the bench order.

DESCRIPTION	CODE
Floor mount	PTFM

**Glides**

Pluto glides are poly.

**Shipment Detail**

200 pounds of weight ballast is shipped separately from the Pluto bench and is required to be installed at the final delivery location.

**Specifications required to create the product code**

- Model
- Seat Upholstery
- Top Upholstery
- Side Upholstery
- Plinth Finish
- Floor Mount (when applicable)

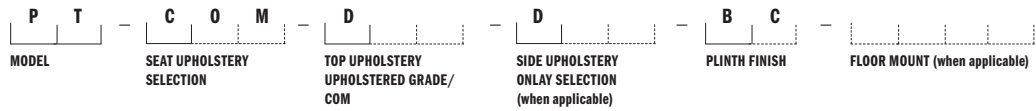

**MODEL**

Pluto (PT)

**SEAT UPHOLSTERY**

COM (COM)

**TOP UPHOLSTERY**

Grade D (D)

**SIDE UPHOLSTERY**

Grade D (D)

**PLINTH FINISH**

Brushed Chrome (BC)

**FLOOR MOUNT**

When applicable, enter Pluto Floor Mount Code



PLUTO BENCH  
Design: Simon Pengelly

PB5

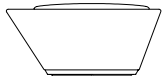

Pluto Bench	MODEL	LIST PRICE/ GRADE	COM/COL	A	B	C	D	E	F	G	H	I	J	K	L	
Powder coat plinth	PT-PC	Powder Coat	\$1667	1890	2002	2114	2226	2338	2450	2562	2674	2786	2899	3010	3122	
W 34 D 37.75 H 16		COM REQUIREMENTS VARY BY COMBINATION SELECTED.														
		TEXTILE REQUIREMENTS:						YARDAGE								
		One textile, entire bench:						3.25 yards								
		Two/Three textile combination														
		Seat:						1 yard								
		Top:						1 yard								
		Side:						1.25 yards								

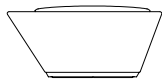

Pluto Bench	MODEL	LIST PRICE/ GRADE	COM/COL	A	B	C	D	E	F	G	H	I	J	K	L	
Brushed chrome plinth	PT-BC	Brushed Chrome	\$1838	2060	2173	2285	2397	2509	2621	2732	2845	2957	3069	3181	3293	
W 34 D 37.75 H 16		COM REQUIREMENTS VARY BY COMBINATION SELECTED.														
		TEXTILE REQUIREMENTS:						YARDAGE								
		One textile, entire bench:						3.25 yards								
		Two/Three textile combination														
		Seat:						1 yard								
		Top:						1 yard								
		Side:						1.25 yards								

To specify:  
Please refer to pages 3-4 for  
complete specifying information.  
Specify all products by their  
product code.

# PLUTO BENCH AUXILIARY OPTION

Design: Simon Pengelly

# PB6

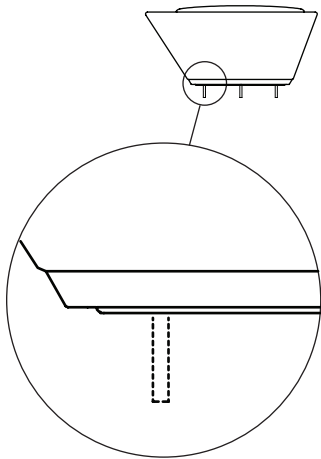

Pluto Floor Mount	MODEL	FRAME FINISH	LIST PRICE
	PTFM	Powder Coat	\$171

Due to the variety of floor surfaces on which the Pluto Bench may be installed, floor mount fasteners are not supplied by Leland International. The Pluto Bench floor mount feature consists of three .5" thru holes designed to use .3125" or .375" threaded studs. Leland International recommends at least 2" of exposed thread length from the floor surface.

Responsibility of fastener choice is the customers.

Floor Mount must be specified at the time of purchasing.

The Floor Mount cannot be added later in the field.

To specify:

Please refer to pages 3-4 for complete specifying information.

Specify all products by their product code.

Pricing Effective: January 2023

---

**5695 Eagle Drive, SE  
Grand Rapids,  
Michigan 49512  
616-975-9260  
lelandfurniture.com**

# Quarry

## January 2023 Price List





# Quarry

Table of Contents	QR2
Bench Specification Information	QR3
Bench Specification Example	QR4
Benches	QR5
Collaborative Work Tools Specification Information	QR6
Collaborative Work Tools Specification Example	QR7
Collaborative Work Tools	QR8
Quarry Groupings	QR9

**Bench Model**

DESCRIPTION	CODE
Flint	QF
Mica	QM
Shale	QS
Quartz	QQ

**Upholstery Selection**

Please refer to Leland Textile Program which features textiles and leathers from the following partners:

- Camira
- Carnegie
- CF Stinson
- Green Hides
- Maharam
- Unika Vaev

The complete grade list can be found at [www.lelandfurniture.com/ecatalog](http://www.lelandfurniture.com/ecatalog) or you can specify COM/COL. Due to the design of this product, it is recommended that all non pre-approved textile be tested for compatibility.

**Stitching Detail**

DESCRIPTION	CODE
Basic (Recommended for patterned textiles)	B
Premium (Standard stitch on Quarry Benches)	P

**Glide Selection**

**STANDARD GLIDES:**

DESCRIPTION	CODE
Poly	P

**OPTIONAL GLIDES:**

DESCRIPTION	CODE
Felt	F

**Auxiliary Options**

DESCRIPTION	CODE
Weight Ballast (50 lbs.)	WB

**Plinth Finish**

All plinths are stainless steel.

Specifications required to create the product code

- Model
- Upholstery Selection
- Stitching Detail
- Glide Selection
- Auxiliary Option (when applicable)



MODEL

Quarry Flint (QF)

UPHOLSTERY SELECTION

Enter upholstery grade or COM.  
Grade D (D)

STITCHING DETAIL

Premium (P)

GLIDE SELECTION

Poly (P)

AUXILIARY OPTION

When applicable



**QUARRY BENCHES**  
Design: Bruce Sienkowski

**QR5**



<b>Flint</b>	<b>MODEL</b>	<b>LIST PRICE/GRADE</b>	<b>COM/COL</b>	<b>A</b>	<b>B</b>	<b>C</b>	<b>D</b>	<b>E</b>	<b>F</b>	<b>G</b>	<b>H</b>	<b>I</b>	<b>J</b>	<b>K</b>	<b>L</b>
W 19 D 18 H 19	QF	\$1283		1396	1452	1510	1568	1625	1682	1740	1796	1855	1911	1969	2026

Optional Glides: Add \$8.00 net per bench for a set of four (4). Optional Glides raise bench height .5 inch.  
 Contrasting Stitch: Add \$25 net per bench - specify black (-CSB) or white thread (-CSW)  
 COM Yardage: 1.25 yards  
 Contact Leland Customer Experience for yardage requirements on textiles with repeats.



<b>Mica</b>	<b>MODEL</b>	<b>LIST PRICE/GRADE</b>	<b>COM/COL</b>	<b>A</b>	<b>B</b>	<b>C</b>	<b>D</b>	<b>E</b>	<b>F</b>	<b>G</b>	<b>H</b>	<b>I</b>	<b>J</b>	<b>K</b>	<b>L</b>
W 19 D 20 H 19	QM	\$1283		1396	1452	1510	1568	1625	1682	1740	1796	1855	1911	1969	2026

Optional Glides: Add \$8.00 net per bench for a set of four (4). Optional Glides raise bench height .5 inch.  
 Contrasting Stitch: Add \$25 net per bench - specify black (-CSB) or white thread (-CSW)  
 COM Yardage: 1.25 yards  
 Contact Leland Customer Experience for yardage requirements on textiles with repeats.

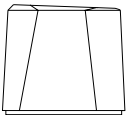

<b>Shale</b>	<b>MODEL</b>	<b>LIST PRICE/GRADE</b>	<b>COM/COL</b>	<b>A</b>	<b>B</b>	<b>C</b>	<b>D</b>	<b>E</b>	<b>F</b>	<b>G</b>	<b>H</b>	<b>I</b>	<b>J</b>	<b>K</b>	<b>L</b>
W 22 D 28.5 H 25.25	QS	\$1410		1566	1643	1722	1799	1877	1955	2032	2110	2187	2265	2343	2420

Optional Glides: Add \$8.00 net per bench for a set of four (4). Optional Glides raise bench height .5 inch.  
 Contrasting Stitch: Add \$25 net per bench - specify black (-CSB) or white thread (-CSW)  
 COM Yardage: 2.25 yards  
 Contact Leland Customer Experience for yardage requirements on textiles with repeats.

<b>Quartz</b>	<b>MODEL</b>	<b>LIST PRICE/GRADE</b>	<b>COM/COL</b>	<b>A</b>	<b>B</b>	<b>C</b>	<b>D</b>	<b>E</b>	<b>F</b>	<b>G</b>	<b>H</b>	<b>I</b>	<b>J</b>	<b>K</b>	<b>L</b>
W 28.5 D 26 H 16.5	QQ	\$1410		1566	1643	1722	1799	1877	1955	2032	2110	2187	2265	2343	2420

Optional Glides: Add \$8.00 net per bench for a set of four (4). Optional Glides raise bench height .5 inch.  
 Contrasting Stitch: Add \$25 net per bench - specify black (-CSB) or white thread (-CSW)  
 COM Yardage: 1.75 yards  
 Contact Leland Customer Experience for yardage requirements on textiles with repeats.

<b>Weight Ballast</b>	<b>MODEL</b>	<b>LIST PRICE</b>
50 lbs.	WB	\$84

To specify:  
 Please refer to pages 3-4 for complete specifying information.  
 Specify all products by their product code.

## Collaborative Work Space Model

DESCRIPTION	CODE
Flint bench with tablet	QFT
Mobile tablet stand	QMT
Power module	QPM

## Tablet Support or Mobile Tablet Column Finish

DESCRIPTION	CODE
White	W
Sterling	ST
Black	B

## Upholstery Selection

Please refer to Leland Textile Program which features textiles and leathers from the following partners:

- Camira
- Green Hides
- Carnegie
- Maharam
- CF Stinson
- Unika Vaev

The complete grade list can be found on our website or you can specify COM/COL. Due to the design of this product, it is recommended that all non pre-approved textile be tested for compatibility.

## Stitching Detail

DESCRIPTION	CODE
Basic (Recommended for patterned textiles)	B
Premium (Standard stitch on Quarry Benches)	P

## Top Surface

DESCRIPTION	CODE
Corian®	C
Wood	V
Laminate	L

## Top Surface Finish or Color

### CORIAN® TOPS:

DESCRIPTION	CODE
Black Corian®	CB
White Corian®	CW
Grey Corian®	CG

### WOOD TOPS:

#### STANDARD LELAND COLORS

\*Natural Finish specify Natural 11

\*\*Custom Finish specify Custom 01

### LAMINATE TOPS:

DESCRIPTION	CODE
Platinum Wilsonart® (D315-60)	LGP
Black Pionite® (SE101)	LBK
White Wilsonart® (D354-60)	LWH

Note that Collaborative Work Tool edges are finished to match for wood tops and Natural 11 for laminate tops.

## Glide Selection

### STANDARD:

DESCRIPTION	CODE
Poly	P

### OPTIONAL:

DESCRIPTION	CODE
Felt	F

## Power Options

DESCRIPTION	CODE
1 Power Unit, three (3) 120v AC receptacles with 7'6" cord	3P
1 Power Unit, four (4) 120v AC receptacles, one (1) USB simplex charger with 7'6" cord	4P

## Freight Note

Due to the size and nature of Quarry Collaborative Work Tools, the Freight Program does not apply to this product. Please contact Customer Experience for a quote.

**Specifications required to create the product code**

- Model
- Tablet Support or Mobile Tablet Stand Column Finish (when applicable)
- Upholstery Selection (when applicable)
- Stitching Detail (when applicable)
- Top Surface
- Top Surface Finish or Color
- Glide Selection
- Power Options (when applicable)



**MODEL**

Quarry Mobile Tablet Stand (QMT)

**TABLET SUPPORT OR MOBILE STAND COLUMN FINISH**

White (W)

**UPHOLSTERY SELECTION**

When applicable, enter upholstery grade or COM

**STITCHING DETAIL**

When applicable

**TOP SURFACE**

Corian® (C)

**TOP SURFACE FINISH OR COLOR**

Grey Corian® (CG)

**GLIDE SELECTION**

When applicable

**POWER OPTIONS**

When applicable



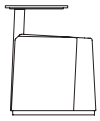

<b>Flint Bench with Tablet</b>				<b>MODEL</b>	<b>LIST PRICE/ GRADE</b>	<b>COM/COL</b>	<b>A</b>	<b>B</b>	<b>C</b>	<b>D</b>	<b>E</b>	<b>F</b>	<b>G</b>	<b>H</b>	<b>I</b>	<b>J</b>	<b>K</b>	<b>L</b>
W 25.6	D 21.5	H 25.5	SH 19	QFT	Corian®	\$2528	2643	2703	2761	2819	2878	2937	2996	3054	3113	3171	3231	3288
					Wood	\$2464	2580	2639	2696	2756	2814	2873	2932	2990	3049	3108	3166	3225
					Laminate	\$2401	2518	2577	2636	2694	2753	2812	2870	2928	2988	3047	3104	3164

Optional Glides: Add \$8.00 net per bench for a set of four (4). Optional Glides raise bench height .5 inch.  
COM Yardage: 1.75 yards  
Contact Leland Customer Experience for yardage requirements on textiles with repeats.

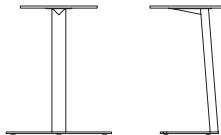

<b>Mobile Tablet Stand</b>			<b>MODEL</b>	<b>FRAME FINISH</b>	<b>LIST PRICE</b>
W 24.7	D 17	H 26	QMT	Corian®	\$1389
				Wood	\$1285
				Laminate	\$1224

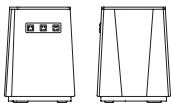

<b>Power Module</b>			<b>MODEL</b>	<b>LIST PRICE/ GRADE</b>	<b>COM/COL</b>	<b>A</b>	<b>B</b>	<b>C</b>	<b>D</b>	<b>E</b>	<b>F</b>	<b>G</b>	<b>H</b>	<b>I</b>	<b>J</b>	<b>K</b>	<b>L</b>	
W 16.5	D 17.25	H 22.4	QPM - _ P	Corian®	\$2863	2980	3038	3098	3155	3214	3274	3332	3390	3449	3508	3566	3625	
three (3) AC receptacles with 7'6" power cord or four (4) AC receptacles, one (1) USB simplex charger, with 7'6" power cord					Wood	\$2791	2906	2966	3023	3082	3141	3200	3258	3317	3376	3434	3493	3552
					Laminate	\$2731	2848	2906	2966	3023	3082	3141	3200	3258	3317	3376	3434	3493

Optional Glides: Add \$8.00 net per bench for a set of four (4). Optional Glides raise bench height .5 inch.  
one (1) USB simplex charger , COM Yardage: 1.5 yards  
with 7'6" power cord Contact Leland Customer Experience for yardage requirements on textiles with repeats.

To specify:  
Please refer to pages 6-7 for complete specifying information.  
Specify all products by their product code.

# QUARRY BENCH GROUPINGS

Design: Bruce Sienkowski

# QR9

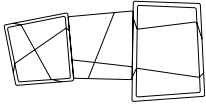

## Example A

### BENCHES

### TOTAL COM LIST PRICE

Flint (QF)

\$3972

Mica (QM)

Shale (QS)

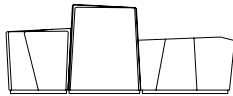
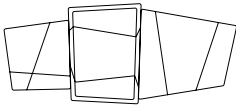

## Example B

### BENCHES

### TOTAL COM LIST PRICE

Mica (QM)

\$4100

Shale (QS)

Quartz (QQ)

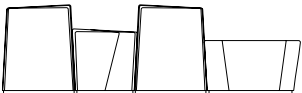
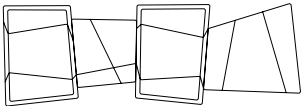

## Example C

### BENCHES

### TOTAL COM LIST PRICE

Shale (QS)

\$5509

Mica (QM)

Shale (QS)

Quartz (QQ)

Please note that example groups are provided as a specification tool. Example groups are shown from top and side profiles. Quarry benches must be ordered as separate line items for each unique model and/or finish specification.

#### To specify:

Please refer to pages 3-4 for complete specifying information.

Specify all products by their product code.



# QUARRY BENCH GROUPINGS

Design: Bruce Sienkowski

# QR10

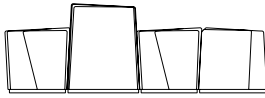
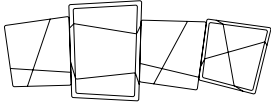

## Example D

### BENCHES

### TOTAL COM LIST PRICE

Mica (QM)

\$5255

Shale (QS)

Mica (QM)

Flint (QF)

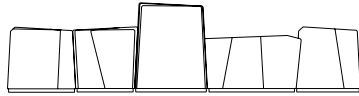
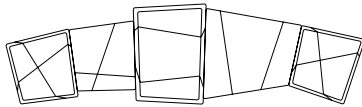

## Example E

### BENCHES

### TOTAL COM LIST PRICE

Flint (QF)

\$6663

Mica (QM)

Shale (QS)

Quartz (QQ)

Flint (QF)

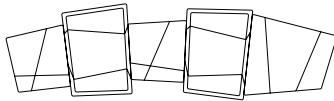

## Example F

### BENCHES

### TOTAL COM LIST PRICE

Mica (QM)

\$6789

Shale (QS)

Mica (QM)

Shale (QS)

Quartz (QQ)

Please note that example groups are provided as a specification tool. Example groups are shown from top and side profiles. Quarry benches must be ordered as separate line items for each unique model and/or finish specification.

**To specify:**

**Please refer to pages 3-4 for complete specifying information.**

**Specify all products by their product code.**

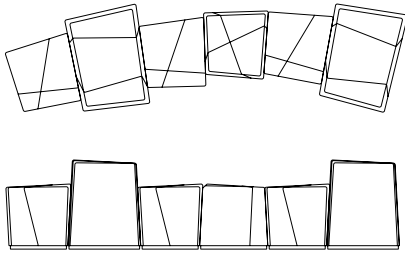

Example G	BENCHES	TOTAL COM LIST PRICE
	Mica (QM)	\$7943
	Shale (QS)	
	Mica (QM)	
	Flint (QF)	
	Mica (QM)	
	Shale (QS)	

Please note that example groups are provided as a specification tool. Example groups are shown from top and side profiles. Quarry benches must be ordered as separate line items for each unique model and/or finish specification.

**To specify:**  
 Please refer to pages 3-4 for complete specifying information.  
 Specify all products by their product code.

---

**5695 Eagle Drive, SE**  
**Grand Rapids,**  
**Michigan 49512**  
**616-975-9260**  
**[lelandfurniture.com](http://lelandfurniture.com)**

# Rapson Forty-Eight

## January 2023 Price List



# Rapson Forty-Eight Chair

Table of Contents	RP48-C2
Specification Information	RP48-C3
Specification Example	RP48-C4
Four Leg Steel Frame Side Chair	RP48-C5
Four Leg Maple Frame Side Chair	RP48-C7
Four Leg Steel Frame Counter Chair	RP48-C9
Four Leg Maple Frame Counter Chair	RP48-C11
Four Leg Steel Frame Bar Chair	RP48-C13
Four Leg Maple Frame Bar Chair	RP48-C15

# RAPSON FORTY-EIGHT CHAIR SPECIFICATION INFORMATION

# RP48-C3

## Chair Model

DESCRIPTION	CODE
Rapson Forty-Eight Four Leg Steel Frame Side Chair	RP48-SS
Rapson Forty-Eight Four Leg Maple Frame Side Chair	RP48-MS
Rapson Forty-Eight Four Leg Steel Frame Counter Chair	RP48-SC
Rapson Forty-Eight Four Leg Maple Frame Counter Chair	RP48-MC
Rapson Forty-Eight Four Leg Steel Frame Bar Chair	RP48-SB
Rapson Forty-Eight Four Leg Maple Frame Bar Chair	RP48-MB

## Shell Options

DESCRIPTION	CODE
Standard Shell	MP
Standard Shell with Upholstered Seat Pad	MPU
Standard HPL Shell	H
Standard HPL Shell with Upholstered Seat Pad	HU
Fully Upholstered	FU
Walnut Shell	W
Walnut Shell with Upholstered Seat Pad	WU
Premium HPL Shell	P
Premium HPL Shell with Upholstered Seat Pad	PU

## Shell Finishes

### STANDARD HPL

(HIGH PRESSURE LAMINATE)

DESCRIPTION	CODE
Fiji	FI
Brittany Blue	BB
Moss Grey	MG
Navaho Red	NR
Fresh Papaya	FP
Forsythia	FS
Kool Kiwi	KK
Honey Plantain	HP
Spicy Flavors	SF
Cafe Sienna	CS
Designer White	WL
Platinum	PL

### PREMIUM HPL

(HIGH PRESSURE LAMINATE)

DESCRIPTION	CODE
Blueberry Tart	BT
Oxidized Silver	OS
Chili Powder	CP
Marmalade	MM
Copper Alloy	CA

### VENEER

#### STANDARD LELAND COLORS (On maple veneer shell only)

DESCRIPTION	CODE
Walnut	W
Maple	MP

## Frame Finish Options

### POWDERCOAT

(FOUR LEG STEEL TUBE)

DESCRIPTION	CODE	DESCRIPTION	CODE
Black	B	Cool Grey	CG
Sterling	ST	Matte Burnish	MBN
Warm Grey	WG	Matte Foundry	MFN
White	W	Matte Mineral	MMN
Matte Mercury	MMR	Matte Blue Sky	MBS
Matte Willow	MWL	Matte Forest	MFO
Matte Sienna	MSN	Black Textured	BT
White Textured	WT	Grey Textured	GT

Pricing Effective: January 2023

## Frame Finish Options (Cont.)

### WOOD

(FOUR LEG WOOD FRAME, ON MAPLE)

DESCRIPTION

LELAND COLORS (Click to view)

## Upholstery Option

Please refer to Leland Textile Program which features textiles and leathers from the following partners:

- Camira
- Green Hides
- Carnegie
- Maharam
- CF Stinson
- Unika Vaev

The complete grade list can be found at [lelandinternational.com/ecatalog](http://lelandinternational.com/ecatalog) or you can specify COM/COL. Due to the design of this product, it is recommended that all non pre-approved textile be tested for compatibility.

## Glide Option

DESCRIPTION	CODE
Nylon (standard)	S
Felt	FC
Floor Saver *only available on metal base	FS
Metal *only available on metal base	M
Rubber *only available on metal base	R

## Auxiliary Options

### PAINTED GRAPHIC BACK

(VENEER SHELL ONLY)

ART

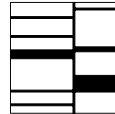

Riff

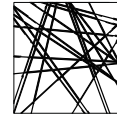

Improve



Bebop

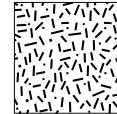

Scat

DESCRIPTION	CODE
Riff	RF
Improv	IM
Bebop	BB
Scat	SC

### PAINTED GRAPHIC COLOR OPTIONS

DESCRIPTION	CODE	DESCRIPTION	CODE
Oxford II	49M	Putty	44M
Dolphin II	50M	Oyster	45M

Only available on veneer shells finished in a clear finish (Natural Walnut 08, Natural Walnut 08M, Natural Maple 11, or Natural Maple 11M).

### SHELL HANDHOLD

DESCRIPTION	CODE
Handhold	HH



RAPSON FORTY-EIGHT FOUR LEG STEEL FRAME  
SIDE CHAIR Design: Ralph Rapson

# RP48-C5



**Rapson Forty-Eight  
Steel Frame Side Chair**

	MODEL	LIST PRICE
Standard HPL Shell	RP48-SS-H	\$625
W 22 D 22.5 H 31.75 SH 18	Optional Glides: Add \$8.00 net per chair for a set of four (4)	



**Rapson Forty-Eight  
Steel Frame Side Chair**

	MODEL	COM/COL	A	B	C	D	E	F	G	H	I	J	K	L
Standard HPL Shell, upholstered seat pad	RP48-SS-HU	\$699	744	768	790	812	835	857	880	902	925	947	970	991
W 22 D 22.5 H 31.75 SH 18	COM Yardage: 1 or 2 chairs: 1 yard Contact Leland Customer Experience for yardage requirements on textiles with repeats. For COL requirements please contact Leland Customer Experience. Optional Glides: Add \$8.00 net per chair for a set of four (4)													



**Rapson Forty-Eight  
Steel Frame Side Chair**

	MODEL	COM/COL	A	B	C	D	E	F	G	H	I	J	K	L
Fully Upholstered	RP48-SS-FU	\$738	826	872	917	962	1007	1052	1097	1141	1187	1232	1277	1322
W 22 D 22.5 H 31.75 SH 18	COM Yardage: 1.5 yards Contact Leland Customer Experience for yardage requirements on textiles with repeats. For COL requirements please contact Leland Customer Experience. Optional Glides: Add \$8.00 net per chair for a set of four (4)													



**Rapson Forty-Eight  
Steel Frame Side Chair**

	MODEL	LIST PRICE
Standard Shell	RP48-SS-MP	\$643
W 22 D 22.5 H 31.75 SH 18	Optional Glides: Add \$8.00 net per chair for a set of four (4)	



**Rapson Forty-Eight  
Steel Frame Side Chair**

	MODEL	COM/COL	A	B	C	D	E	F	G	H	I	J	K	L
Standard Shell, upholstered seat pad	RP48-SS-MPU	\$718	763	786	809	832	854	877	898	921	943	965	988	1010
W 22 D 22.5 H 31.75 SH 18	COM Yardage: 1 or 2 chairs: 1 yard Contact Leland Customer Experience for yardage requirements on textiles with repeats. For COL requirements please contact Leland Customer Experience. Optional Glides: Add \$8.00 net per chair for a set of four (4)													

**To specify:  
Please refer to pages 3-4 for  
complete specifying information.  
Specify all products by their  
product code.**



RAPSON FORTY-EIGHT FOUR LEG STEEL FRAME  
SIDE CHAIR Design: Ralph Rapson

# RP48-C6



**Rapson Forty-Eight  
Steel Frame Side Chair**

	MODEL	LIST PRICE
Walnut Shell	RP48-SS-W	\$663
W 22 D 22.5 H 31.75 SH 18	Optional Glides: Add \$8.00 net per chair for a set of four (4)	



**Rapson Forty-Eight  
Steel Frame Side Chair**

	MODEL	COM/COL	A	B	C	D	E	F	G	H	I	J	K	L
Walnut Shell, upholstered seat pad	RP48-SS-WU	\$738	782	804	826	849	872	895	917	940	962	985	1007	1030
W 22 D 22.5 H 31.75 SH 18	COM Yardage: 1 or 2 chairs: 1 yard Contact Leland Customer Experience for yardage requirements on textiles with repeats. For COL requirements please contact Leland Customer Experience. Optional Glides: Add \$8.00 net per chair for a set of four (4)													



**Rapson Forty-Eight  
Steel Frame Side Chair**

	MODEL	LIST PRICE
Premium HPL Shell	RP48-SS-P	\$817
W 22 D 22.5 H 31.75 SH 18	Optional Glides: Add \$8.00 net per chair for a set of four (4)	



**Rapson Forty-Eight  
Steel Frame Side Chair**

	MODEL	COM/COL	A	B	C	D	E	F	G	H	I	J	K	L
Premium HPL Shell, upholstered seat pad	RP48-SS-PU	\$893	938	960	983	1005	1026	1049	1071	1094	1116	1139	1161	1184
W 22 D 22.5 H 31.75 SH 18	COM Yardage: 1 or 2 chairs: 1 yard Contact Leland Customer Experience for yardage requirements on textiles with repeats. For COL requirements please contact Leland Customer Experience. Optional Glides: Add \$8.00 net per chair for a set of four (4)													

**To specify:**  
 Please refer to pages 3-4 for  
 complete specifying information.  
 Specify all products by their  
 product code.

**Pricing Effective: January 2023**

RAPSON FORTY-EIGHT MAPLE FRAME  
SIDE CHAIR Design: Ralph Rapson

# RP48-C7

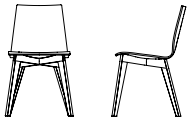

**Rapson Forty-Eight  
Maple Frame Side Chair**

	MODEL	LIST PRICE
Standard HPL Shell	RP48-MS-H	\$882
W 19.5 D 21.25 H 32 SH 18.25		Optional Glides: Add \$8.00 net per chair for a set of four (4)

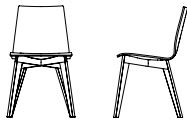

**Rapson Forty-Eight  
Maple Frame Side Chair**

	MODEL	COM/COL	A	B	C	D	E	F	G	H	I	J	K	L
Standard HPL Shell, upholstered seat pad	RP48-MS-HU	\$958	1002	1024	1047	1069	1092	1114	1137	1159	1182	1204	1227	1250
W 19.5 D 21.25 H 32 SH 18.25		COM Yardage: 1 or 2 chairs: 1 yard Contact Leland Customer Experience for yardage requirements on textiles with repeats. For COL requirements please contact Leland Customer Experience. Optional Glides: Add \$8.00 net per chair for a set of four (4)												

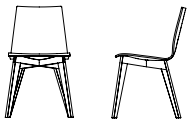

**Rapson Forty-Eight  
Maple Frame Side Chair**

	MODEL	COM/COL	A	B	C	D	E	F	G	H	I	J	K	L
Fully Upholstered	RP48-MS-FU	\$994	1084	1129	1174	1219	1264	1309	1355	1400	1445	1489	1534	1579
W 19.5 D 21.5 H 32 SH 18.25		COM Yardage: 1.5 yards Contact Leland Customer Experience for yardage requirements on textiles with repeats. For COL requirements please contact Leland Customer Experience. Optional Glides: Add \$8.00 net per chair for a set of four (4)												

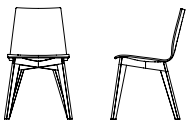

**Rapson Forty-Eight  
Maple Frame Side Chair**

	MODEL	LIST PRICE
Standard Shell	RP48-MS-MP	\$901
W 19.5 D 21.25 H 32 SH 18.25		Optional Glides: Add \$8.00 net per chair for a set of four (4)

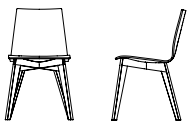

**Rapson Forty-Eight  
Maple Frame Side Chair**

	MODEL	COM/COL	A	B	C	D	E	F	G	H	I	J	K	L
Standard Shell, upholstered seat pad	RP48-MS-MPU	\$975	1021	1044	1066	1088	1111	1133	1156	1178	1201	1222	1245	1267
W 19.5 D 21.5 H 32 SH 18.25		COM Yardage: 1.5 yards Contact Leland Customer Experience for yardage requirements on textiles with repeats. For COL requirements please contact Leland Customer Experience. Optional Glides: Add \$8.00 net per chair for a set of four (4)												

**To specify:  
Please refer to pages 3-4 for  
complete specifying information.  
Specify all products by their  
product code.**

RAPSON FORTY-EIGHT MAPLE FRAME  
SIDE CHAIR Design: Ralph Rapson

# RP48-C8

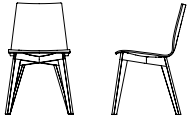

**Rapson Forty-Eight  
Maple Frame Side Chair**

	MODEL	LIST PRICE
Walnut Shell	RP48-MS-W	\$919
W 19.5 D 21.5 H 32 SH 18.25	Optional Glides: Add \$8.00 net per chair for a set of four (4)	

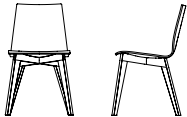

**Rapson Forty-Eight  
Maple Frame Side Chair**

	MODEL	COM/COL	A	B	C	D	E	F	G	H	I	J	K	L
Walnut Shell, upholstered seat pad	RP48-MS-WU	\$994	1040	1063	1084	1107	1129	1152	1174	1197	1219	1242	1264	1286
W 19.5 D 21.5 H 32 SH 18.25	COM Yardage: 1 or 2 chairs: 1 yard Contact Leland Customer Experience for yardage requirements on textiles with repeats. For COL requirements please contact Leland Customer Experience. Optional Glides: Add \$8.00 net per chair for a set of four (4)													

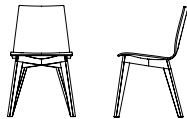

**Rapson Forty-Eight  
Maple Frame Side Chair**

	MODEL	LIST PRICE
Premium HPL Shell	RP48-MS-P	\$1075
W 19.5 D 21.5 H 32 SH 18.25	Optional Glides: Add \$8.00 net per chair for a set of four (4)	

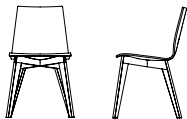

**Rapson Forty-Eight  
Maple Frame Side Chair**

	MODEL	COM/COL	A	B	C	D	E	F	G	H	I	J	K	L
Premium HPL Shell, Upholstered seat pad	RP48-MS-PU	\$1149	1194	1217	1239	1262	1284	1307	1329	1352	1373	1397	1419	1442
W 19.5 D 21.5 H 32 SH 18.25	COM Yardage: 1 or 2 chairs: 1 yard Contact Leland Customer Experience for yardage requirements on textiles with repeats. For COL requirements please contact Leland Customer Experience. Optional Glides: Add \$8.00 net per chair for a set of four (4)													

To specify:  
Please refer to pages 3-4 for complete specifying information.  
Specify all products by their product code.

Pricing Effective: January 2023

RAPSON FORTY-EIGHT FOUR LEG STEEL FRAME  
COUNTER CHAIR Design: Ralph Rapson

# RP48-C9



**Rapson Forty-Eight  
Steel Frame Counter Chair**

	MODEL	LIST PRICE
Standard HPL Shell	RP48-SC-H	\$883

W 19.75 D 20.75 H 32 SH 24

Optional Glides: Add \$8.00 net per chair for a set of four (4)

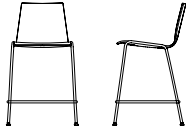

**Rapson Forty-Eight  
Steel Frame Counter Chair**

	MODEL	COM/COL	A	B	C	D	E	F	G	H	I	J	K	L
Standard HPL Shell, upholstered seat pad	RP48-SC-HU	\$959	1003	1025	1048	1070	1093	1115	1138	1160	1183	1205	1229	1251

W 19.75 D 20.75 H 32 SH 24

COM Yardage: 1 or 2 chairs: 1 yard  
Contact Leland Customer Experience for yardage requirements on textiles with repeats.  
For COL requirements please contact Leland Customer Experience.  
Optional Glides: Add \$8.00 net per chair for a set of four (4)

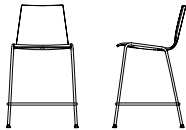

**Rapson Forty-Eight  
Steel Frame Counter Chair**

	MODEL	COM/COL	A	B	C	D	E	F	G	H	I	J	K	L
Fully Upholstered	RP48-SC-FU	\$995	1086	1130	1175	1220	1265	1310	1356	1401	1446	1490	1535	1580

W 19.75 D 20.75 H 32 SH 24

COM Yardage: 1.5 yards  
Contact Leland Customer Experience for yardage requirements on textiles with repeats.  
For COL requirements please contact Leland Customer Experience.  
Optional Glides: Add \$8.00 net per chair for a set of four (4)

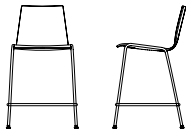

**Rapson Forty-Eight  
Steel Frame Counter Chair**

	MODEL	LIST PRICE
Standard Shell	RP48-SC-MP	\$902

W 19.75 D 20.75 H 32 SH 24

Optional Glides: Add \$8.00 net per chair for a set of four (4)

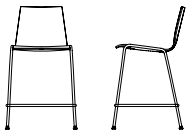

**Rapson Forty-Eight  
Steel Frame Counter Chair**

	MODEL	COM/COL	A	B	C	D	E	F	G	H	I	J	K	L
Standard Shell, upholstered seat pad	RP48-SC-MPU	\$977	1022	1045	1067	1090	1112	1135	1157	1179	1202	1223	1246	1268

W 19.75 D 20.75 H 32 SH 24

COM Yardage: 1 or 2 chairs: 1 yard  
Contact Leland Customer Experience for yardage requirements on textiles with repeats.  
For COL requirements please contact Leland Customer Experience.  
Optional Glides: Add \$8.00 net per chair for a set of four (4)

**To specify:  
Please refer to pages 3-4 for  
complete specifying information.  
Specify all products by their  
product code.**

RAPSON FORTY-EIGHT FOUR LEG STEEL FRAME  
COUNTER CHAIR Design: Ralph Rapson

# RP48-C10

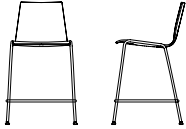

**Rapson Forty-Eight  
Steel Frame Counter Chair**

MODEL	LIST PRICE
Walnut Shell RP48-SC-W W 19.75 D 20.75 H 32 SH 24	\$921

Optional Glides: Add \$8.00 net per chair for a set of four (4)

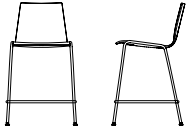

**Rapson Forty-Eight  
Steel Frame Counter Chair**

MODEL	COM/COL	A	B	C	D	E	F	G	H	I	J	K	L
Walnut Shell, upholstered seat pad RP48-SC-WU W 19.75 D 20.75 H 32 SH 24	\$995	1041	1064	1086	1109	1130	1153	1175	1198	1220	1243	1265	1288

COM Yardage: 1 or 2 chairs: 1 yard  
Contact Leland Customer Experience for yardage requirements on textiles with repeats.  
For COL requirements please contact Leland Customer Experience.  
Optional Glides: Add \$8.00 net per chair for a set of four (4)

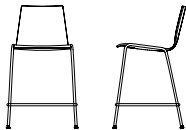

**Rapson Forty-Eight  
Steel Frame Counter Chair**

MODEL	LIST PRICE
Premium HPL Shell RP48-SC-P W 19.75 D 20.75 H 32 SH 24	\$1076

Optional Glides: Add \$8.00 net per chair for a set of four (4)

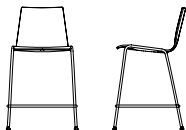

**Rapson Forty-Eight  
Steel Frame Counter Chair**

MODEL	COM/COL	A	B	C	D	E	F	G	H	I	J	K	L
Premium HPL Shell, Upholstered seat pad RP48-SC-PU W 19.75 D 20.75 H 32 SH 24	\$1151	1191	1214	1235	1258	1280	1303	1325	1347	1370	1392	1415	1437

COM Yardage: 1 or 2 chairs: 1 yard  
Contact Leland Customer Experience for yardage requirements on textiles with repeats.  
For COL requirements please contact Leland Customer Experience.  
Optional Glides: Add \$8.00 net per chair for a set of four (4)

To specify:  
Please refer to pages 3-4 for complete specifying information.  
Specify all products by their product code.

Pricing Effective: January 2023

RAPSON FORTY-EIGHT MAPLE FRAME  
COUNTER CHAIR Design: Ralph Rapson

# RP48-C11

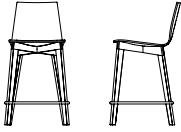

**Rapson Forty-Eight  
Maple Frame Counter Chair**

	MODEL	LIST PRICE
Standard HPL Shell	RP48-MC-H	\$1399

W 18.5 D 20 H 35 SH 24

Optional Glides: Add \$8.00 net per chair for a set of four (4)

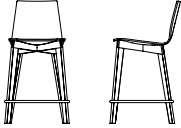

**Rapson Forty-Eight  
Maple Frame Counter Chair**

	MODEL	COM/COL	A	B	C	D	E	F	G	H	I	J	K	L
Standard HPL Shell, upholstered seat pad	RP48-MC-HU	\$1473	1518	1540	1562	1586	1608	1631	1652	1675	1697	1720	1742	1765

W 18.5 D 20 H 35 SH 24

COM Yardage: 1 or 2 chairs: 1 yard  
Contact Leland Customer Experience for yardage requirements on textiles with repeats.  
For COL requirements please contact Leland Customer Experience.  
Optional Glides: Add \$8.00 net per chair for a set of four (4)

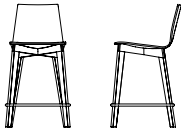

**Rapson Forty-Eight  
Maple Frame Counter Chair**

	MODEL	COM/COL	A	B	C	D	E	F	G	H	I	J	K	L
Fully Upholstered	RP48-MC-FU	\$1510	1600	1645	1691	1736	1780	1825	1870	1914	1959	2004	2050	2095

W 18.5 D 20 H 35 SH 24

COM Yardage: 1.5 yards  
Contact Leland Customer Experience for yardage requirements on textiles with repeats.  
For COL requirements please contact Leland Customer Experience.  
Optional Glides: Add \$8.00 net per chair for a set of four (4)

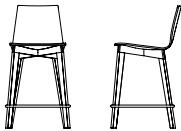

**Rapson Forty-Eight  
Maple Frame Counter Chair**

	MODEL	LIST PRICE
Standard Shell	RP48-MC-MP	\$1416

W 18.5 D 20 H 35 SH 24

Optional Glides: Add \$8.00 net per chair for a set of four (4)

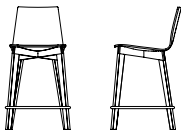

**Rapson Forty-Eight  
Maple Frame Counter Chair**

	MODEL	COM/COL	A	B	C	D	E	F	G	H	I	J	K	L
Standard Shell, upholstered seat pad	RP48-MC-MPU	\$1492	1536	1558	1581	1603	1626	1649	1672	1694	1716	1739	1761	1784

W 18.5 D 20 H 35 SH 24

COM Yardage: 1 or 2 chairs: 1 yard  
Contact Leland Customer Experience for yardage requirements on textiles with repeats.  
For COL requirements please contact Leland Customer Experience.  
Optional Glides: Add \$8.00 net per chair for a set of four (4)

**To specify:  
Please refer to pages 3-4 for  
complete specifying information.  
Specify all products by their  
product code.**

RAPSON FORTY-EIGHT MAPLE FRAME  
COUNTER CHAIR Design: Ralph Rapson

# RP48-C12

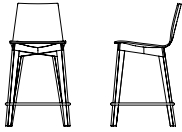

**Rapson Forty-Eight  
Maple Frame Counter Chair**

	MODEL	LIST PRICE
Walnut Shell	RP48-MC-W	\$1565
W 18.5 D 20 H 35 SH 24	Optional Glides: Add \$8.00 net per chair for a set of four (4)	

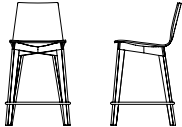

**Rapson Forty-Eight  
Maple Frame Counter Chair**

	MODEL	COM/COL	A	B	C	D	E	F	G	H	I	J	K	L
Walnut Shell, upholstered seat pad	RP48-MC-WU	\$1638	1683	1706	1728	1751	1773	1797	1819	1842	1864	1887	1909	1930
W 18.5 D 20 H 35 SH 24	COM Yardage: 1 or 2 chairs: 1 yard Contact Leland Customer Experience for yardage requirements on textiles with repeats. For COL requirements please contact Leland Customer Experience. Optional Glides: Add \$8.00 net per chair for a set of four (4)													

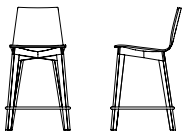

**Rapson Forty-Eight  
Maple Frame Counter Chair**

	MODEL	LIST PRICE
Premium HPL Shell	RP48-MC-P	\$1719
W 18.5 D 20 H 35 SH 24	Optional Glides: Add \$8.00 net per chair for a set of four (4)	

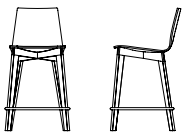

**Rapson Forty-Eight  
Maple Frame Counter Chair**

	MODEL	COM/COL	A	B	C	D	E	F	G	H	I	J	K	L
Premium HPL Shell, Upholstered seat pad	RP48-MC-PU	\$1794	1838	1861	1883	1906	1928	1951	1973	1996	2018	2041	2063	2086
W 18.5 D 20 H 35 SH 24	COM Yardage: 1 or 2 chairs: 1 yard Contact Leland Customer Experience for yardage requirements on textiles with repeats. For COL requirements please contact Leland Customer Experience. Optional Glides: Add \$8.00 net per chair for a set of four (4)													

To specify:  
Please refer to pages 3-4 for complete specifying information.  
Specify all products by their product code.

Pricing Effective: January 2023

RAPSON FORTY-EIGHT FOUR LEG STEEL FRAME  
BAR CHAIR Design: Ralph Rapson

# RP48-C13



**Rapson Forty-Eight  
Steel Frame Bar Chair**

	MODEL	LIST PRICE
Standard HPL Shell	RP48-SB-H	\$898

W 20 D 23 H 41 SH 30

Optional Glides: Add \$8.00 net per chair for a set of four (4)



**Rapson Forty-Eight  
Steel Frame Bar Chair**

	MODEL	COM/COL	A	B	C	D	E	F	G	H	I	J	K	L
Standard HPL Shell, upholstered seat pad	RP48-SB-HU	\$973	1019	1041	1064	1086	1109	1130	1153	1175	1198	1220	1243	1265

W 20 D 23 H 41 SH 30

COM Yardage: 1 or 2 chairs: 1 yard  
Contact Leland Customer Experience for yardage requirements on textiles with repeats.  
For COL requirements please contact Leland Customer Experience.  
Optional Glides: Add \$8.00 net per chair for a set of four (4)



**Rapson Forty-Eight  
Steel Frame Bar Chair**

	MODEL	COM/COL	A	B	C	D	E	F	G	H	I	J	K	L
Fully Upholstered	RP48-SB-FU	\$1010	1100	1146	1191	1235	1280	1325	1370	1415	1461	1506	1551	1596

W 20 D 23 H 41 SH 30

COM Yardage: 1.5 yards  
Contact Leland Customer Experience for yardage requirements on textiles with repeats.  
For COL requirements please contact Leland Customer Experience.  
Optional Glides: Add \$8.00 net per chair for a set of four (4)

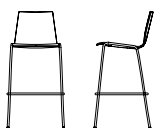

**Rapson Forty-Eight  
Steel Frame Bar Chair**

	MODEL	LIST PRICE
Standard Shell	RP48-SB-MP	\$917

W 20 D 23 H 41 SH 30

Optional Glides: Add \$8.00 net per chair for a set of four (4)



**Rapson Forty-Eight  
Steel Frame Bar Chair**

	MODEL	COM/COL	A	B	C	D	E	F	G	H	I	J	K	L
Standard Shell, upholstered seat pad	RP48-SB-MPU	\$991	1036	1059	1082	1105	1127	1149	1172	1194	1217	1239	1262	1284

W 20 D 23 H 41 SH 30

COM Yardage: 1 or 2 chairs: 1 yard  
Contact Leland Customer Experience for yardage requirements on textiles with repeats.  
For COL requirements please contact Leland Customer Experience.  
Optional Glides: Add \$8.00 net per chair for a set of four (4)

**To specify:  
Please refer to pages 3-4 for  
complete specifying information.  
Specify all products by their  
product code.**



RAPSON FORTY-EIGHT FOUR LEG STEEL FRAME  
BAR CHAIR Design: Ralph Rapson

# RP48-C14

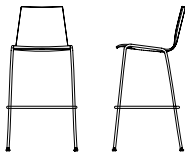

**Rapson Forty-Eight  
Steel Frame Bar Chair**

	MODEL	LIST PRICE
Walnut Shell	RP48-SB-W	\$938
W 20 D 23 H 41 SH 30	Optional Glides: Add \$8.00 net per chair for a set of four (4)	

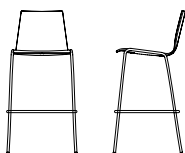

**Rapson Forty-Eight  
Steel Frame Bar Chair**

	MODEL	COM/COL	A	B	C	D	E	F	G	H	I	J	K	L
Walnut Shell, upholstered seat pad	RP48-SB-WU	\$1012	1056	1079	1101	1125	1147	1170	1192	1215	1237	1260	1281	1304
W 20 D 23 H 41 SH 30	COM Yardage: 1 or 2 chairs: 1 yard Contact Leland Customer Experience for yardage requirements on textiles with repeats. For COL requirements please contact Leland Customer Experience. Optional Glides: Add \$8.00 net per chair for a set of four (4)													

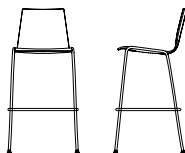

**Rapson Forty-Eight  
Steel Frame Bar Chair**

	MODEL	LIST PRICE
Premium HPL Shell	RP48-SB-P	\$1091
W 20 D 23 H 41 SH 30	Optional Glides: Add \$8.00 net per chair for a set of four (4)	

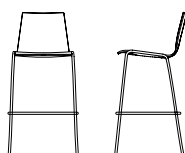

**Rapson Forty-Eight  
Steel Frame Bar Chair**

	MODEL	COM/COL	A	B	C	D	E	F	G	H	I	J	K	L
Premium HPL Shell, Upholstered seat pad	RP48-SB-PU	\$1048	1205	1229	1251	1274	1296	1318	1341	1362	1385	1407	1430	1452
W 20 D 23 H 41 SH 30	COM Yardage: 1 or 2 chairs: 1 yard Contact Leland Customer Experience for yardage requirements on textiles with repeats. For COL requirements please contact Leland Customer Experience. Optional Glides: Add \$8.00 net per chair for a set of four (4)													

**To specify:**  
 Please refer to pages 3-4 for  
 complete specifying information.  
 Specify all products by their  
 product code.

**Pricing Effective: January 2023**

RAPSON FORTY-EIGHT MAPLE FRAME  
BAR CHAIR Design: Ralph Rapson

# RP48-C15



**Rapson Forty-Eight  
Maple Frame Bar Chair**

	MODEL	LIST PRICE
Standard HPL Shell	RP48-MB-H	\$1670
W 19.5 D 20.5 H 41 SH 30		Optional Glides: Add \$8.00 net per chair for a set of four (4)



**Rapson Forty-Eight  
Maple Frame Bar Chair**

	MODEL	COM/COL	A	B	C	D	E	F	G	H	I	J	K	L
Standard HPL Shell, upholstered seat pad	RP48-MB-HU	\$1744	1789	1812	1834	1857	1880	1903	1925	1948	1970	1992	2015	2037
W 19.5 D 20.5 H 41 SH 30		COM Yardage: 1 or 2 chairs: 1 yard Contact Leland Customer Experience for yardage requirements on textiles with repeats. For COL requirements please contact Leland Customer Experience. Optional Glides: Add \$8.00 net per chair for a set of four (4)												



**Rapson Forty-Eight  
Maple Frame Bar Chair**

	MODEL	COM/COL	A	B	C	D	E	F	G	H	I	J	K	L
Fully Upholstered	RP48-MB-FU	\$1783	1872	1917	1962	2007	2052	2097	2142	2187	2231	2276	2322	2367
W 19.5 D 20.5 H 41 SH 30		COM Yardage: 1.5 yards Contact Leland Customer Experience for yardage requirements on textiles with repeats. For COL requirements please contact Leland Customer Experience. Optional Glides: Add \$8.00 net per chair for a set of four (4)												



**Rapson Forty-Eight  
Maple Frame Bar Chair**

	MODEL	LIST PRICE
Standard Shell	RP48-MB-MP	\$1689
W 19.5 D 20.5 H 41 SH 30		Optional Glides: Add \$8.00 net per chair for a set of four (4)



**Rapson Forty-Eight  
Maple Frame Bar Chair**

	MODEL	COM/COL	A	B	C	D	E	F	G	H	I	J	K	L
Standard Shell, upholstered seat pad	RP48-SB-MPU	\$1764	1809	1831	1853	1876	1898	1922	1944	1966	1988	2011	2033	2056
W 19.5 D 20.5 H 41 SH 30		COM Yardage: 1 or 2 chairs: 1 yard Contact Leland Customer Experience for yardage requirements on textiles with repeats. For COL requirements please contact Leland Customer Experience. Optional Glides: Add \$8.00 net per chair for a set of four (4)												

**To specify:**  
Please refer to pages 3-4 for complete specifying information.  
Specify all products by their product code.

RAPSON FORTY-EIGHT FOUR MAPLE FRAME  
BAR CHAIR Design: Ralph Rapson

# RP48-C16



**Rapson Forty-Eight  
Maple Frame Bar Chair**

	MODEL	LIST PRICE
Walnut Shell	RP48-MB-W	\$1836
W 19.5 D 20.5 H 41 SH 30	Optional Glides: Add \$8.00 net per chair for a set of four (4)	



**Rapson Forty-Eight  
Maple Frame Bar Chair**

	MODEL	COM/COL	A	B	C	D	E	F	G	H	I	J	K	L
Walnut Shell, upholstered seat pad	RP48-MB-WU	\$1912	1957	1980	2002	2025	2046	2070	2092	2114	2137	2159	2182	2204
W 19.5 D 20.5 H 41 SH 30	COM Yardage: 1 or 2 chairs: 1 yard Contact Leland Customer Experience for yardage requirements on textiles with repeats. For COL requirements please contact Leland Customer Experience. Optional Glides: Add \$8.00 net per chair for a set of four (4)													



**Rapson Forty-Eight  
Maple Frame Bar Chair**

	MODEL	LIST PRICE
Premium HPL Shell	RP48-MB-P	\$1991
W 19.5 D 20.5 H 41 SH 30	Optional Glides: Add \$8.00 net per chair for a set of four (4)	



**Rapson Forty-Eight  
Maple Frame Bar Chair**

	MODEL	COM/COL	A	B	C	D	E	F	G	H	I	J	K	L
Premium HPL Shell, Upholstered seat pad	RP48-MB-PU	\$2065	2111	2134	2156	2179	2201	2224	2246	2269	2290	2312	2335	2357
W 19.5 D 20.5 H 41 SH 30	COM Yardage: 1 or 2 chairs: 1 yard Contact Leland Customer Experience for yardage requirements on textiles with repeats. For COL requirements please contact Leland Customer Experience. Optional Glides: Add \$8.00 net per chair for a set of four (4)													

**To specify:**  
 Please refer to pages 3-4 for  
 complete specifying information.  
 Specify all products by their  
 product code.

**Pricing Effective: January 2023**

<b>Painted Back</b>	<b>MODEL</b>	<b>LIST PRICE</b>
	Reference color codes on page RP48-C3	\$194

<b>Handhold</b>	<b>MODEL</b>	<b>LIST PRICE</b>
	HH	\$34

To specify:  
Please refer to pages 3-4 for  
complete specifying information.  
Specify all products by their  
product code.

---

**5695 Eagle Drive, SE**  
**Grand Rapids,**  
**Michigan 49512**  
**616-975-9260**  
**[lelandfurniture.com](http://lelandfurniture.com)**

# Rapson Thirty-Nine Bench

January 2023 Price List



# Rapson Thirty-Nine Bench

Table of Contents	RP39-BN2
Specification Information	RP39-BN3
Specification Example	RP39-BN4
Rapson Thirty-Nine Bench 20"	RP39-BN5
Rapson Thirty-Nine Bench 48"	RP39-BN5

## Bench Model

---

DESCRIPTION	CODE
Rapson Thirty-Nine Bench	RP39-BN

## Bench Width

---

DESCRIPTION	CODE
20"	20
48"	48

## Bench Frame and Button Finish Options

---

DESCRIPTION	CODE
Natural Walnut	08M
Natural Ash	07M

## Upholstery Selection

---

Please refer to Leland Textile Program which features textiles and leathers from the following partners:

- Camira
- Carnegie
- CF Stinson
- Green Hides
- Maharam
- Unika Vaev

The complete grade list can be found at [lelandinternational.com/ecatalog](http://lelandinternational.com/ecatalog) or you can specify COM/COL. Due to the design of this product, it is recommended that all non pre-approved textile be tested for compatibility.

## Glide Option

---

DESCRIPTION	CODE
Nylon (standard)	S
Felt	F



## Specifications required to create the product code

- Model
- Bench Width
- Bench Frame and Button Finish Selection
- Upholstery Selection
- Glide Option

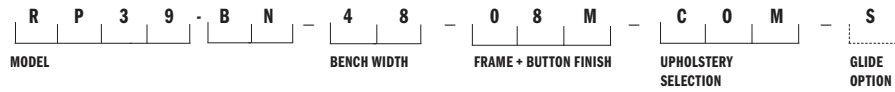

### MODEL

Rapson Thirty-Nine Bench (RP39-BN)

### BENCH WIDTH

48" (48)

### BENCH FRAME + BUTTON FINISH

Natural Walnut (08M)

### UPHOLSTERY SELECTION

Enter upholstery grade or COM

### GLIDE OPTION

Nylon (S)



RAPSON THIRTY-NINE BENCH  
Design: Ralph Rapson

# RP39-BN5

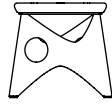
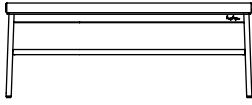

Rapson Thirty-Nine	MODEL	COM/COL	A	B	C	D	E	F	G	H	I	J	K	L
48" Bench	RP39-BN-48	\$2227	2318	2365	2411	2456	2502	2548	2594	2639	2685	2730	2776	2822

W 48.5 D 19.25 H 18.5

COM Yardage: 1.5 yards  
Contact Leland Customer Experience for yardage requirements on textiles with repeats.  
For COL requirements please contact Leland Customer Experience.

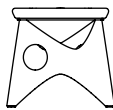

Rapson Thirty-Nine	MODEL	COM/COL	A	B	C	D	E	F	G	H	I	J	K	L
20" Bench	RP39-BN-20	\$1393	1424	1440	1454	1470	1486	1500	1515	1530	1546	1560	1576	1591

W 19.5 D 19.25 H 18.5

COM Yardage: 1.5 yards  
Contact Leland Customer Experience for yardage requirements on textiles with repeats.  
For COL requirements please contact Leland Customer Experience.

To specify:  
Please refer to pages 3-4 for complete specifying information.  
Specify all products by their product code.

Pricing Effective: January 2023

---

**5695 Eagle Drive, SE  
Grand Rapids,  
Michigan 49512  
616-975-9260  
lelandfurniture.com**

# Rapson Thirty-Nine Guest

## January 2023 Price List



# Rapson Thirty- Nine Guest

Table of Contents	RP39-G2
Specification Information	RP39-G3
Specification Example	RP39-G4
Guest Chair	RP39-G5

## Chair Model

---

DESCRIPTION	CODE
Rapson Thirty-Nine Guest Chair	RP39-G

## Frame Finish Options

---

DESCRIPTION	CODE
Natural Walnut	08M
Natural Ash	07M

## Fully Upholstered or Onlay Selection

---

Please refer to Leland Textile Program which features textiles and leathers from the following partners:

- Camira
- Carnegie
- CF Stinson
- Green Hides
- Maharam
- Unika Vaev

The complete grade list can be found at [www.lelandfurniture.com/ecatalog](http://www.lelandfurniture.com/ecatalog) or you can specify COM/COL. Due to the design of this product, it is recommended that all non pre-approved textile be tested for compatibility.

## Optional Contrasted Upper Back Upholstery

---

Please refer to Leland Textile Program which features textiles and leathers from the following partners:

- Camira
- Carnegie
- CF Stinson
- Green Hides
- Maharam
- Unika Vaev

The complete grade list can be found at [www.lelandfurniture.com/ecatalog](http://www.lelandfurniture.com/ecatalog) or you can specify COM/COL. Due to the design of this product, it is recommended that all non pre-approved textile be tested for compatibility.

## Glide Option

---

DESCRIPTION	CODE
Nylon (standard)	S
Felt	F

## Specifications required to create the product code

- Model
- Frame Finish Selection
- Upholstery Selection
- Optional Upper Back Upholstery
- Glide Option

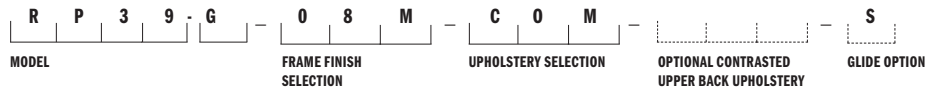

### MODEL

Rapson Thirty-Nine Guest (RP39-G)

### FRAME FINISH

Natural Walnut (08M)

### UPHOLSTERY SELECTION

Enter upholstery grade or COM

### GLIDE OPTION

Nylon (S)



RAPSON THIRTY-NINE GUEST  
 Design: Ralph Rapson

# RP39-G5

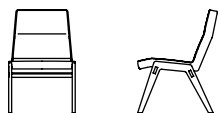

**Rapson Thirty-Nine**

	MODEL	COM/COL	A	B	C	D	E	F	G	H	I	J	K	L
Guest Chair	RP39-G	\$2648	2739	2786	2832	2878	2923	2969	3015	3060	3106	3152	3197	3243

W 22 D 27 H 35 SH 18.5

COM Yardage: 1 seat: 2.75 yards  
 Contact Leland Customer Experience for yardage requirements on textiles with repeats.  
 Optional Glides: Add \$8.00 net per chair for a set of four (4).

To specify:  
 Please refer to pages 3-4 for complete specifying information.  
 Specify all products by their product code.

Pricing Effective: January 2023



---

**5695 Eagle Drive, SE  
Grand Rapids,  
Michigan 49512  
616-975-9260  
lelandfurniture.com**

# Rapson Thirty-Nine Lounge

January 2023 Price List



# Rapson Thirty-Nine Lounge

Table of Contents	RP39-L2
Specification Information	RP39-L3
Specification Example	RP39-L4
Rapson Thirty-Nine Lounge	RP39-L5

## Chair Model

---

DESCRIPTION	CODE
Rapson Thirty-Nine Lounge Chair	RP39-L

## Frame Finish Options

---

DESCRIPTION	CODE
Natural Walnut	08M
Natural Ash	07M

## Fully Upholstered or Onlay Selection

---

Please refer to Leland Textile Program which features textiles and leathers from the following partners:

- Camira
- Carnegie
- CF Stinson
- Green Hides
- Maharam
- Unika Vaev

The complete grade list can be found at [www.lelandfurniture.com/ecatalog](http://www.lelandfurniture.com/ecatalog) or you can specify COM/COL. Due to the design of this product, it is recommended that all non pre-approved textile be tested for compatibility.

## Glide Option

---

DESCRIPTION	CODE
Nylon (standard)	S
Felt	F

## Specifications required to create the product code

- Model
- Frame Finish Selection
- Upholstery Selection
- Glide Option

**R** **P** **3** **9** - **L** - **0** **8** **M** - **C** **O** **M** - **S**  
MODEL                      FRAME FINISH                      UPHOLSTERY SELECTION                      GLIDE OPTION

### MODEL

Rapson Thirty-Nine Lounge (RP39-L)

### FRAME FINISH

Natural Walnut (08M)

### UPHOLSTERY SELECTION

Enter upholstery grade or COM

### GLIDE OPTION

Nylon (S)



RAPSON THIRTY-NINE LOUNGE  
 Design: Ralph Rapson

# RP39-L5

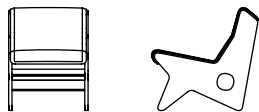

**Rapson Thirty-Nine**

	MODEL	COM/COL	A	B	C	D	E	F	G	H	I	J	K	L
Lounge Chair	RP39-L	\$3137	3245	3299	3352	3406	3459	3512	3566	3619	3673	3726	3779	3834

W 24 D 32.25 H 31 SH 18.25

COM Yardage: 1 seat: 1.75 yards  
 Contact Leland Customer Experience for yardage requirements on textiles with repeats.  
 Optional Glides: Add \$8.00 net per chair for a set of four (4).

To specify:  
 Please refer to pages 3-4 for complete specifying information.  
 Specify all products by their product code.

**Pricing Effective: January 2023**

---

**5695 Eagle Drive, SE  
Grand Rapids,  
Michigan 49512  
616-975-9260  
lelandfurniture.com**

# Rapson Thirty-Nine Guest

## January 2023 Price List





# Rapson Thirty-Nine Guest

Table of Contents	RP39-G2
Specification Information	RP39-G3
Specification Example	RP39-G4
Guest Chair	RP39-G5

## Chair Model

---

DESCRIPTION	CODE
Rapson Thirty-Nine Guest Chair	RP39-G

## Frame Finish Options

---

DESCRIPTION	CODE
Natural Walnut	08M
Natural Ash	07M

## Fully Upholstered or Onlay Selection

---

Please refer to Leland Textile Program which features textiles and leathers from the following partners:

- Camira
- Carnegie
- CF Stinson
- Green Hides
- Maharam
- Unika Vaev

The complete grade list can be found at [www.lelandfurniture.com/ecatalog](http://www.lelandfurniture.com/ecatalog) or you can specify COM/COL. Due to the design of this product, it is recommended that all non pre-approved textile be tested for compatibility.

## Optional Contrasted Upper Back Upholstery

---

Please refer to Leland Textile Program which features textiles and leathers from the following partners:

- Camira
- Carnegie
- CF Stinson
- Green Hides
- Maharam
- Unika Vaev

The complete grade list can be found at [www.lelandfurniture.com/ecatalog](http://www.lelandfurniture.com/ecatalog) or you can specify COM/COL. Due to the design of this product, it is recommended that all non pre-approved textile be tested for compatibility.

## Glide Option

---

DESCRIPTION	CODE
Nylon (standard)	S
Felt	F

## Specifications required to create the product code

- Model
- Frame Finish Selection
- Upholstery Selection
- Optional Upper Back Upholstery
- Glide Option

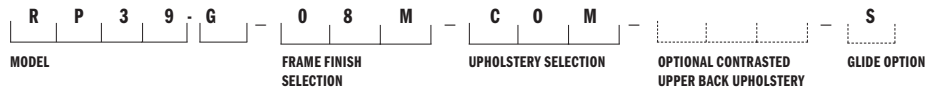

### MODEL

Rapson Thirty-Nine Guest (RP39-G)

### FRAME FINISH

Natural Walnut (08M)

### UPHOLSTERY SELECTION

Enter upholstery grade or COM

### GLIDE OPTION

Nylon (S)



RAPSON THIRTY-NINE GUEST  
 Design: Ralph Rapson

# RP39-G5

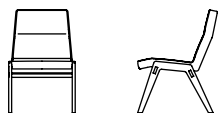

**Rapson Thirty-Nine**

	MODEL	COM/COL	A	B	C	D	E	F	G	H	I	J	K	L
Guest Chair	RP39-G	\$2648	2739	2786	2832	2878	2923	2969	3015	3060	3106	3152	3197	3243

W 22 D 27 H 35 SH 18.5

COM Yardage: 1 seat: 2.75 yards  
 Contact Leland Customer Experience for yardage requirements on textiles with repeats.  
 Optional Glides: Add \$8.00 net per chair for a set of four (4).

To specify:  
 Please refer to pages 3-4 for complete specifying information.  
 Specify all products by their product code.

Pricing Effective: January 2023

---

**5695 Eagle Drive, SE  
Grand Rapids,  
Michigan 49512  
616-975-9260  
lelandfurniture.com**

# Rapson Thirty-Nine Bench

January 2023 Price List



# Rapson Thirty-Nine Bench

Table of Contents	RP39-BN2
Specification Information	RP39-BN3
Specification Example	RP39-BN4
Rapson Thirty-Nine Bench 20"	RP39-BN5
Rapson Thirty-Nine Bench 48"	RP39-BN5

## Bench Model

---

DESCRIPTION	CODE
Rapson Thirty-Nine Bench	RP39-BN

## Bench Width

---

DESCRIPTION	CODE
20"	20
48"	48

## Bench Frame and Button Finish Options

---

DESCRIPTION	CODE
Natural Walnut	08M
Natural Ash	07M

## Upholstery Selection

---

Please refer to Leland Textile Program which features textiles and leathers from the following partners:

- Camira
- Green Hides
- Carnegie
- Maharam
- CF Stinson
- Unika Vaev

The complete grade list can be found at [lelandinternational.com/ecatalog](http://lelandinternational.com/ecatalog) or you can specify COM/COL. Due to the design of this product, it is recommended that all non pre-approved textile be tested for compatibility.

## Glide Option

---

DESCRIPTION	CODE
Nylon (standard)	S
Felt	F



RAPSON THIRTY-NINE BENCH  
SPECIFICATION EXAMPLE

# RP39-BN4

## Specifications required to create the product code

- Model
- Bench Width
- Bench Frame and Button Finish Selection
- Upholstery Selection
- Glide Option

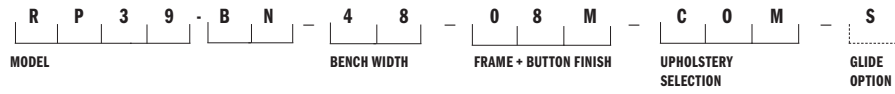

### MODEL

Rapson Thirty-Nine Bench (RP39-BN)

### BENCH WIDTH

48" (48)

### BENCH FRAME + BUTTON FINISH

Natural Walnut (08M)

### UPHOLSTERY SELECTION

Enter upholstery grade or COM

### GLIDE OPTION

Nylon (S)



RAPSON THIRTY-NINE BENCH  
Design: Ralph Rapson

# RP39-BN5

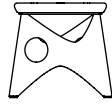
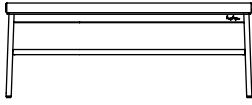

Rapson Thirty-Nine	MODEL	COM/COL	A	B	C	D	E	F	G	H	I	J	K	L
48" Bench	RP39-BN-48	\$2227	2318	2365	2411	2456	2502	2548	2594	2639	2685	2730	2776	2822

W 48.5 D 19.25 H 18.5

COM Yardage: 1.5 yards  
Contact Leland Customer Experience for yardage requirements on textiles with repeats.  
For COL requirements please contact Leland Customer Experience.

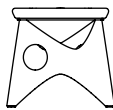

Rapson Thirty-Nine	MODEL	COM/COL	A	B	C	D	E	F	G	H	I	J	K	L
20" Bench	RP39-BN-20	\$1393	1424	1440	1454	1470	1486	1500	1515	1530	1546	1560	1576	1591

W 19.5 D 19.25 H 18.5

COM Yardage: 1.5 yards  
Contact Leland Customer Experience for yardage requirements on textiles with repeats.  
For COL requirements please contact Leland Customer Experience.

To specify:  
Please refer to pages 3-4 for complete specifying information.  
Specify all products by their product code.

Pricing Effective: January 2023

---

**5695 Eagle Drive, SE**  
**Grand Rapids,**  
**Michigan 49512**  
**616-975-9260**  
**[lelandfurniture.com](http://lelandfurniture.com)**

# Rapson Thirty-Nine Lounge

January 2023 Price List



# Rapson Thirty-Nine Lounge

Table of Contents	RP39-L2
Specification Information	RP39-L3
Specification Example	RP39-L4
Rapson Thirty-Nine Lounge	RP39-L5

## Chair Model

---

DESCRIPTION	CODE
Rapson Thirty-Nine Lounge Chair	RP39-L

## Frame Finish Options

---

DESCRIPTION	CODE
Natural Walnut	08M
Natural Ash	07M

## Fully Upholstered or Onlay Selection

---

Please refer to Leland Textile Program which features textiles and leathers from the following partners:

- Camira
- Carnegie
- CF Stinson
- Green Hides
- Maharam
- Unika Vaev

The complete grade list can be found at [www.lelandfurniture.com/ecatalog](http://www.lelandfurniture.com/ecatalog) or you can specify COM/COL. Due to the design of this product, it is recommended that all non pre-approved textile be tested for compatibility.

## Glide Option

---

DESCRIPTION	CODE
Nylon (standard)	S
Felt	F

## Specifications required to create the product code

- Model
- Frame Finish Selection
- Upholstery Selection
- Glide Option

**R** **P** **3** **9** - **L** - **0** **8** **M** - **C** **O** **M** - **S**  
MODEL                      FRAME FINISH                      UPHOLSTERY SELECTION                      GLIDE OPTION

### MODEL

Rapson Thirty-Nine Lounge (RP39-L)

### FRAME FINISH

Natural Walnut (08M)

### UPHOLSTERY SELECTION

Enter upholstery grade or COM

### GLIDE OPTION

Nylon (S)



RAPSON THIRTY-NINE LOUNGE  
 Design: Ralph Rapson

# RP39-L5

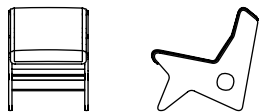

**Rapson Thirty-Nine**

	MODEL	COM/COL	A	B	C	D	E	F	G	H	I	J	K	L
Lounge Chair	RP39-L	\$3137	3245	3299	3352	3406	3459	3512	3566	3619	3673	3726	3779	3834

W 24 D 32.25 H 31 SH 18.25

COM Yardage: 1 seat: 1.75 yards  
 Contact Leland Customer Experience for yardage requirements on textiles with repeats.  
 Optional Glides: Add \$8.00 net per chair for a set of four (4).

To specify:  
 Please refer to pages 3-4 for complete specifying information.  
 Specify all products by their product code.

**Pricing Effective: January 2023**



---

**5695 Eagle Drive, SE  
Grand Rapids,  
Michigan 49512  
616-975-9260  
lelandfurniture.com**

# Slam Beam

## January 2023 Price List



# Slam Beam

Table of Contents	SB2
Configurative Overview	SB3
Order Diagram	SB4
Visual Reference	SB5
Specification Information	SB8
Specification Example	SB9
Base, Two Position	SB10
Base, Three Position	SB11
Base, Four Position	SB12
Shell Specification Information	SB13
Specification Example	SB14
Shell Selection	SB15
Table Specification Information	SB17
Table Specification Example	SB18
Table	SB19
Floor Mount	SB20

## Slam Beam Seating Configuration

---

Slam Beam can be configured in many ways to meet the needs of your public space. The following pages will provide you a step by step process to correctly configure your benches. **Each purchase order submitted requires the diagram on page SB17 of this price list to be completed for every different bench model.** This is to ensure that the product you receive is exactly what you intended to purchase. If Leland can be of any assistance to you, please don't hesitate to contact our Customer Experience Department at 800-859-7510.

### 1. Base Selection

---

Begin configuring Slam Beam by selecting a base. Bases are available in three or four positions, either with arms or armless.

### 2. Shell Added to Base

---

The Slam shell is designed to fit one base position. Shells are available in polypropylene or 3D Veneer with or without upholstery. When placing an order, each shell is considered a separate product and will require its own model number.

### 3. Table Added to Base (Optional)

---

Slam Beam tables fit one base position. Table surface selections are available as a laminate. When placing an order, each table is considered a separate product and will require its own model number.

Please complete and include with your order. If multiple units are ordered, a diagram must be completed for each unique unit.

## 1. Slam Beam Base Selection

Select a three position or four position base model number:

The gray boxes below represent the seat/table positions of the model. Specify from left to right as seated. \*Note diagram (bottom is front of bench).

### TWO (2) POSITION

SB2NA, two position, armless

SB22A, two position, two arm

SB23A, two position, three arm

### THREE (3) POSITION

SB3NA, three position, armless

SB32A, three position, two arm

SB34A, three position, four arm

### FOUR (4) POSITION

SB4NA, four position, armless

SB42A, four position, two arm

SB45A, four position, five arm

## 2. SLAM BEAM SHELL AND TABLE SELECTION

Please select either a shell or a table for each position on your base. Then choose the surface materials. Positions should be specified from left to right as seated.

### POSITION ONE POSITION TWO

Shell

Polypropylene

Polypropylene

w/ Uph. Seat Onlay

Fully Uph.

Oak 3D Veneer

Oak 3D Veneer w/

Uph. Seat Onlay

Tables

### POSITION THREE

Shell

Polypropylene

Polypropylene

w/ Uph. Seat Onlay

Fully Uph.

Oak 3D Veneer

Oak 3D Veneer w/

Uph. Seat Onlay

Tables

### POSITION FOUR

Shell

Polypropylene

Polypropylene

w/ Uph. Seat Onlay

Fully Uph.

Oak 3D Veneer

Oak 3D Veneer w/

Uph. Seat Onlay

Tables

### POSITION FIVE

Shell

Polypropylene

Polypropylene

w/ Uph. Seat Onlay

Fully Uph.

Oak 3D Veneer

Oak 3D Veneer w/

Uph. Seat Onlay

Tables

TWO POSITION ARMLESS

---

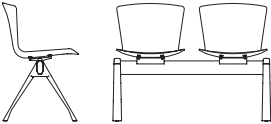

TWO POSITION, TWO ARM

---

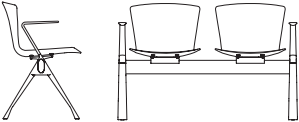

TWO POSITION, THREE ARM

---

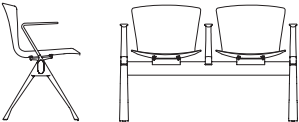

THREE POSITION ARMLESS

---

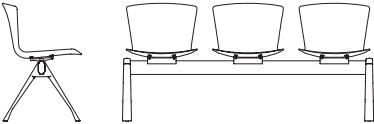

THREE POSITION, TWO ARM

---

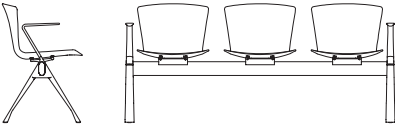

THREE POSITION, FOUR ARM

---

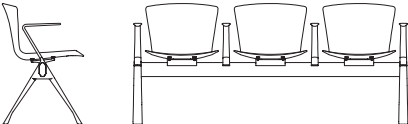

FOUR POSITION ARMLESS

---

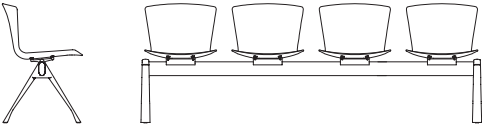

FOUR POSITION, TWO ARM

---

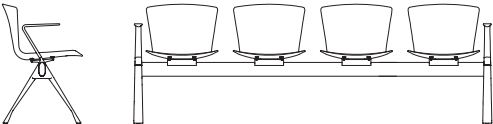

FOUR POSITION, FIVE ARM

---

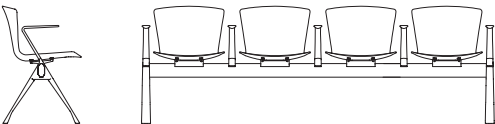



## Beam Model

---

TWO POSITION	CODE
Armless	SB2NA
Two Arm	SB22A
Three Arm	SB23A

THREE POSITION	CODE
Armless	SB3NA
Two Arm	SB32A
Four Arm	SB34A

FOUR POSITION	CODE
Armless	SB4NA
Two Arm	SB42A
Five Arm	SB45A

## Beam Finish

---

DESCRIPTION	CODE
White Textured	WT
Black Textured	BT
Grey Textured	GT
Dolphin Textured	DLT
Oxford Textured	OXT
Sterling	ST

## Glides

---

Slam Beam glides are nylon.

## Auxiliary Options

---

DESCRIPTION	CODE
Floor Mount	FM

For a quote on Floor Mount options, please contact Customer Experience.

## Freight Note

---

Due to the size and nature of Slam Beam, the Freight Program does not apply to this product. Please contact Customer Experience for a quote.

**Specifications required to create the product code**

- Model
- Beam Finish
- Floor Mount (when applicable)



**MODEL**

Three position,  
Armless (SB3NA)

**BEAM FINISH**

White Textured Powder coat (WT)

**FLOOR MOUNT**

When applicable, enter Slam Beam  
Floor Mount Code (FM)



SLAM BEAM BASE, TWO POSITION  
Design: Lievore Altherr Molina, licensed by Sellex

# SB10

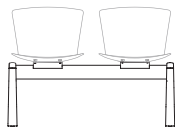

<b>Two Position, Armless</b>	<b>MODEL</b>	<b>LIST PRICE</b>
W 39.25 D 21 H 31	SB2NA Powdercoat	\$2284

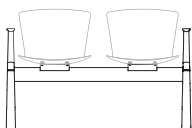

<b>Two Position, Two Arm</b>	<b>MODEL</b>	<b>LIST PRICE</b>
W 43.5 D 21 H 31	SB22A Powdercoat	\$2439

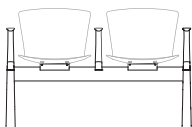

<b>Two Position, Three Arm</b>	<b>MODEL</b>	<b>LIST PRICE</b>
W 43.5 D 21 H 31	SB23A Powdercoat	\$2595

To specify:  
Refer to pages SB6-SB7

SLAM BEAM BASE, THREE POSITION  
Design: Lievore Altherr Molina, licensed by Sellex

# SB11

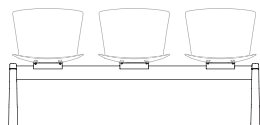

**Three Position, Armless**

MODEL

LIST PRICE

W 66 D 21 H 31

SB3NA

Powdercoat

\$2425

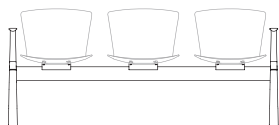

**Three Position, Two Arm**

MODEL

LIST PRICE

W 70.25 D 21 H 31

SB32A

Powdercoat

\$2581

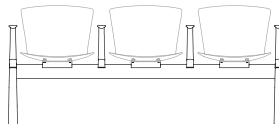

**Three Position, Three Arm**

MODEL

LIST PRICE

W 70.25 D 21 H 31

SB34A

Powdercoat

\$2736

To specify:  
Refer to pages SB6-SB7

Pricing Effective: January 2023

SLAM BEAM BASE, FOUR POSITION  
 Design: Lievore Altherr Molina, licensed by Sellex

# SB12

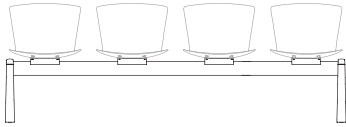

<b>Four Position, Armless</b>	<b>MODEL</b>	<b>LIST PRICE</b>
W 88.5 D 21 H 31	SB4NA Powdercoat	\$2788

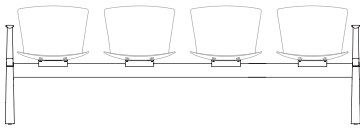

<b>Four Position, Two Arm</b>	<b>MODEL</b>	<b>LIST PRICE</b>
W 93 D 21 H 31	SB42A Powdercoat	\$2944

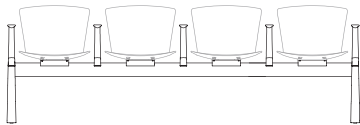

<b>Four Position, Five Arm</b>	<b>MODEL</b>	<b>LIST PRICE</b>
W 93 D 21 H 31	SB45A Powdercoat	\$3178

To specify:  
 Refer to pages SB6-SB7

**Shell Selection**

DESCRIPTION	CODE
Polypropylene	PO
Polypropylene with Upholstered Seat Onlay	PU
Fully Upholstered	FU
Beech 3D Veneer	3DB
Beech 3D Veneer with Upholstered Seat Onlay	3BU
Oak 3D Veneer	3DO
Oak 3D Veneer with Upholstered Seat Onlay	3OU

**Shell Finish**

**POLYPROPYLENE SHELL:**

DESCRIPTION	CODE	DESCRIPTION	CODE
White	W	Dolphin	DL
Black	B	Oxford	OX
Fawn	FW	Blue Sky	BS
Fog	FG	Forest	FO
Pine	PN	Pistachio	PS

**BEECH 3D VENEER SHELL:**

DESCRIPTION	CODE	DESCRIPTION	CODE
Natural Beech	09M	Neutral	15M
Medium	13M	Classic Mahogany	21M
White Wash II	30M	Espresso	23M
Transparent Black	29M	Graphite	25M
Oxford II	49M	Dolphin II	50M
Blue Sky	100M	Forest	101M
Pistachio	110M		

**OAK 3D VENEER SHELL:**

DESCRIPTION	CODE
Natural White Oak	12M
Pine	109M
Fog	111M

**Shell Upholstery**

**FULLY UPHOLSTERED SHELL**

Please refer to Leland Textile Program which features textiles and leathers from the following partners:

- Camira
- Green Hides
- Carnegie
- Maharam
- CF Stinson
- Unika Vaev

The complete grade list can be found at [www.lelandfurniture.com/ecatalog](http://www.lelandfurniture.com/ecatalog) or you can specify COM/COL. Due to the design of this product, it is recommended that all non pre-approved textile be tested for compatibility.

**Upholstered Onlay selection**

Please refer to Leland Textile Program which features textiles and leathers from the following partners:

- Camira
- Green Hides
- Carnegie
- Maharam
- CF Stinson
- Unika Vaev

The complete grade list can be found at [lelandinternational.com/ecatalog](http://lelandinternational.com/ecatalog) or you can specify COM/COL. Due to the design of this product, it is recommended that all non pre-approved textile be tested for compatibility.

**Specifications required to create the product code**

- Shell Selection
- Shell Finish
- Upholstered Onlay Selection (When Applicable)

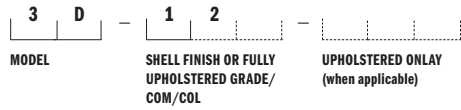

**SHELL SELECTION**

3D Veneer Shell (3D)

**SHELL FINISH**

Natural White Oak (12)

**UPHOLSTERED ONLAY SELECTION**

When applicable, enter upholstery grade, COM or COL

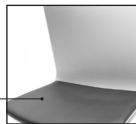

**SLAM BEAM SHELL SELECTION**  
 Design: Lievore Altherr Molina, licensed by Sellex

# SB15



<b>Polypropylene</b>	<b>MODEL</b>	<b>LIST PRICE</b>
	PO	\$186



<b>Polypropylene W/ Upholstered Seat Only</b>	<b>MODEL</b>	<b>COM/COL</b>	<b>A</b>	<b>B</b>	<b>C</b>	<b>D</b>	<b>E</b>	<b>F</b>	<b>G</b>	<b>H</b>	<b>I</b>	<b>J</b>	<b>K</b>	<b>L</b>
	PU	\$307	374	407	441	474	507	541	574	607	642	675	708	742

COM Yardage: 1 or 2 seats: .75 yard  
 Contact Leland Customer Experience for yardage requirements on textiles with repeats.  
 For COL requirements please contact Leland Customer Experience.



<b>Fully Upholstered</b>	<b>MODEL</b>	<b>COM/COL</b>	<b>A</b>	<b>B</b>	<b>C</b>	<b>D</b>	<b>E</b>	<b>F</b>	<b>G</b>	<b>H</b>	<b>I</b>	<b>J</b>	<b>K</b>	<b>L</b>
	FU	\$436	505	540	575	610	646	680	716	752	786	822	856	891

COM Yardage: 1 or 2 seats: .75 yard  
 Contact Leland Customer Experience for yardage requirements on textiles with repeats.  
 For COL requirements please contact Leland Customer Experience.

**To specify:**  
 Refer to pages SB11-SB12



SLAM BEAM SHELL SELECTION  
 Design: Lievore Altherr Molina, licensed by Sellex

# SB16



3D Beech Veneer	MODEL	LIST PRICE
	3DB	\$622



3D Beech Veneer W/ Upholstered Seat Only	MODEL	COM/COL	A	B	C	D	E	F	G	H	I	J	K	L
	3BU	\$746	812	845	880	913	946	980	1013	1046	1080	1113	1146	1181

COM Yardage: 1 or 2 seats: .75 yard  
 Contact Leland Customer Experience for yardage requirements on textiles with repeats.  
 For COL requirements please contact Leland Customer Experience.



3D Oak Veneer	MODEL	LIST PRICE
	3DO	\$785



3D Oak Veneer W/ Upholstered Seat Only	MODEL	COM/COL	A	B	C	D	E	F	G	H	I	J	K	L
	30U	\$908	974	1008	1041	1074	1108	1141	1174	1208	1242	1275	1309	1342

COM Yardage: 1 or 2 seats: .75 yard  
 Contact Leland Customer Experience for yardage requirements on textiles with repeats.  
 For COL requirements please contact Leland Customer Experience.

To specify:  
 Refer to pages SB11-SB12

**Table Model**

---

DESCRIPTION	CODE
Slam table	SBT

**Top Finish or Color**

---

**LAMINATE TOP:**

DESCRIPTION	CODE
Black (Pionite® Suede Black)	LBK
White (WilsonArt® Designer White) LWH Custom	CST

**Edge Finish**

---

DESCRIPTION	CODE
Opaque Black	B
Opaque White	W
Natural	11

**Specifications required to create the product code**

- Table Model
- Top Finish
- Edge Finish



**TABLE MODEL**

Slam Beam Table (SBT)

**TOP FINISH**

White Laminate (W)

**EDGE FINISH**

Opaque White (W)



<b>Slam Beam Table</b>	<b>MODEL</b>	<b>FRAME FINISH</b>	<b>LIST PRICE</b>
one base position	SBT	Laminate	\$296

W 22 D 22  
TH 17.75 (MOUNTED TO BASE)

Please note that Opaque White and Opaque Black Edge Finishes will have an additional \$20 NET charge.



To specify:  
Refer to pages SB14-SB15

Slam Beam Floor Mount	MODEL	LIST PRICE
	SBFM	\$196

Floor mount must be specified at the time of order.  
Due to the variety of floor surfaces on which Slam Beam may be installed, floor mount fasteners are not supplied by Leland.  
Responsibility of fastener choice is the customers.

To specify:  
Refer to pages SB14-SB15

---

**5695 Eagle Drive, SE  
Grand Rapids,  
Michigan 49512  
616-975-9260  
lelandfurniture.com**

# Slam

## January 2023 Price List



# Slam

Table of Contents	SL2
Specification Information	SL3
Specification Example	SL4
Sled Base	SL5
Stacking Four-Leg Base	SL7
Stacking Arm Chair, Four-Leg Base	SL9
Wood Leg Chair	SL11
Stacking Four-Leg Mobile Base	SL13
Side Chair, Aluminum Base	SL15
Arm Chair, Aluminum Base	SL17
Task Base	SL19
Sled Counter Chair	SL21
Four-Leg Counter Chair	SL23
Sled Bar Chair	SL25
Four-Leg Bar Chair	SL27
Stacking/Transport Dolly	SL29
Slam Lounge	SL30



**Chair Model**

DESCRIPTION	CODE
SLAM sled base	SLS
SLAM stacking 4-leg base	SL4
SLAM stacking arm chair, 4-leg base	SL4A
SLAM stacking 4-leg mobile base	SLM
SLAM side chair, 4-leg aluminum base	SLA
SLAM arm chair, 4-leg aluminum base	SLAA
SLAM task base	SLTB
SLAM side chair, beech wood leg	SLW
SLAM side chair, oak wood leg	SLWO
SLAM sled, counter chair	SLCS
SLAM 4-leg, counter chair	SLC4
SLAM sled, bar chair	SLBS
SLAM 4-leg, bar chair	SLB4
SLAM lounge	SLL

**Shell Selection**

DESCRIPTION	CODE
Polypropylene	PO
Polypropylene with Upholstered Seat Onlay	PU
Fully Upholstered	FU
3D Beech Veneer	3DB
3D Beech Veneer with Upholstered Seat Onlay	3BU
3D Oak Veneer	3DO
3D Oak Veneer with Upholstered Seat Onlay	3OU

**Shell Finish/Color**

**POLYPROPYLENE SHELL:**

DESCRIPTION	CODE	DESCRIPTION	CODE
White	WT	Oxford	OX
Black	BK	Forest	FO
Fawn	FW	Pine	PN
Fog	FG	Pistachio	PS
Blue Sky	BS	Dolphin	DL

**CUSTOM POLYPROPYLENE COLORS**

Custom color match is available upon request. Please contact hello@lelandfurniture.com for further information

**BEECH 3D VENEER SHELL AND/OR WOOD LEG:**

DESCRIPTION	CODE	DESCRIPTION	CODE
Natural Beech	09	Graphite	25M
Neutral	15	Oxford II	49M
Medium	13	Dolphin II	50M
Classic Mahogany	21M	Blue Sky	100M
White Wash II	30M	Forest	101M
Espresso	23M	Pistachio	110M
Transparent Black	29M		

**OAK 3D VENEER SHELL AND/OR WOOD LEG:**

DESCRIPTION	ODE
Natural White Oak	12
Pine	109M
Fog	111M

**Frame Finish**

DESCRIPTION	CODE	DESCRIPTION	CODE
Black	B	White	W
Warm Grey	WG	Cool Grey	CG
Matte Mercury	MMR	Matte Burnish	MBN
Matte Mineral	MMN	Matte Foundry	MFN
Matte Fawn	MFW	Matte Blue Sky	MBS
Matte Fog	MFG	Matte Pine	MPN
Matte Forest	MFO	Sterling	ST
Matte Pistachio	MPS	Polished Aluminum	P
Chrome	C	*Aluminum models only	

**Textured Frame Finishes**

DESCRIPTION	CODE	DESCRIPTION	CODE
White Textured	WT	Black Textured	BT
Grey Textured	GT	Dolphin Textured	DLT
Oxford Textured	OXT		

**Glide or Caster Type**

**STANDARD GLIDES:**

DESCRIPTION	CODE
Poly (Sled base)	S
Nylon (4-Leg, Aluminum base)	S
Rubber (Slam Wood Leg)	S

**OPTIONAL GLIDES:**

DESCRIPTION	CODE
Felt	FC
Floor Saver™ (for VCT type floors) (4-Leg base only)	FS
Metal (4-Leg base only)	M
Rubber (4-Leg base or Aluminum Base only)	R

\*Please note that optional glides for four leg models raise the chair height .5 inch.

**CASTER TYPE:**

(for 4-leg mobile and task base)

DESCRIPTION	CODE
Hard Floor Caster	HF
Soft Floor Caster	SF

**Fully Upholstered or Onlay Selection**

Please refer to Leland Textile Program which features textiles and leathers from the following partners:

- Camira
- Green Hides
- Carnegie
- Maharam
- CF Stinson
- Unika Vaev

The complete grade list can be found at [www.lelandfurniture.com/ecatalog](http://www.lelandfurniture.com/ecatalog) or you can specify COM/COL. Due to the design of this product, it is recommended that all non pre-approved textile be tested for compatibility.

**Stacking note**

SLAM side chair 4 leg base, stacking arm chair, and 4 leg mobile base are the only models available for stacking.

**Specifications required to create the product code**

- Model
- Shell Selection
- Shell Finish
- Upholstered Onlay Selection (when applicable)
- Frame Finish
- Glide or Caster Type

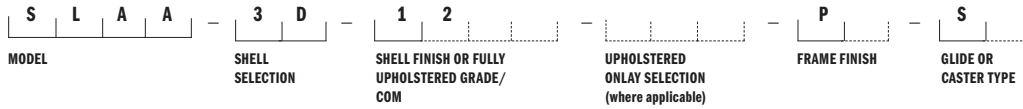

**MODEL**

Slam arm chair, aluminum base (SLAA)

**SHELL SELECTION**

3D Veneer (3D)

**SHELL FINISH**

Natural White Oak (12)

**UPHOLSTERED ONLAY SELECTION**

When applicable, enter upholstery grade, COM



**FRAME FINISH**

Polished Aluminum (P)

**GLIDE OR CASTER TYPE**

Standard Nylon (S)



# SLAM SLED BASE CHAIR

Design: Lievore Altherr Molina, licensed by Sellex

# SL5



Slam Sled Base Chair	MODEL	FRAME FINISH	LIST PRICE
Polypropylene shell	SLS-PO	Powder Coat	\$466
W 22.5 D 20.75 H 31.75 SH 18		Chrome	\$532



Slam Sled Base Chair	MODEL	LIST PRICE/GRADE	COM/COL	A	B	C	D	E	F	G	H	I	J	K	L
Polypropylene shell, upholstered seat onlay	SLS-PU	Powder Coat	\$612	680	716	751	785	821	857	891	927	962	996	1032	1067
		Chrome	\$678	748	782	817	853	887	924	959	993	1029	1064	1098	1134
W 22.5 D 20.75 H 31.75 SH 18.25		COM Yardage: 1 or 2 seats: .75 yard Contact Leland Customer Experience for yardage requirements on textiles with repeats. For COL requirements please contact Leland Customer Experience.													



Slam Sled Base Chair	MODEL	LIST PRICE/GRADE	COM/COL	A	B	C	D	E	F	G	H	I	J	K	L
Fully upholstered	SLS-FU	Powder Coat	\$688	810	871	932	993	1054	1115	1176	1237	1298	1359	1420	1481
		Chrome	\$754	876	937	998	1059	1120	1181	1242	1303	1364	1425	1486	1547
W 22.5 D 20.75 H 31.75 SH 18.25		COM Yardage: 1 seat: 1.5 yards Contact Leland Customer Experience for yardage requirements on textiles with repeats. For COL requirements please contact Leland Customer Experience.													

**To specify:**  
**Please refer to pages 3-4 for complete specifying information.**  
**Specify all products by their product code.**

**Pricing Effective: January 2023**

**SLAM SLED BASE CHAIR**  
 Design: Lievore Altherr Molina, licensed by Sellex

**SL6**



<b>Slam Sled Base Chair</b>	<b>MODEL</b>	<b>FRAME FINISH</b>	<b>LIST PRICE</b>
3D Beech veneer shell	SLS-3DB	Powder Coat	\$1084
W 22.5 D 20.75 H 31.75 SH 18		Chrome	\$1232



<b>Slam Sled Base Chair</b>	<b>MODEL</b>	<b>LIST PRICE/ GRADE</b>	<b>COM/COL</b>	<b>A</b>	<b>B</b>	<b>C</b>	<b>D</b>	<b>E</b>	<b>F</b>	<b>G</b>	<b>H</b>	<b>I</b>	<b>J</b>	<b>K</b>	<b>L</b>
3D Beech veneer shell, upholstered seat onlay	SLS-3BU	Powder Coat	\$1232	1301	1336	1372	1407	1442	1477	1512	1547	1582	1617	1654	1688
		Chrome	\$1299	1367	1404	1439	1474	1509	1544	1579	1614	1649	1684	1720	1755
W 22.5 D 20.75 H 31.75 SH 18.25		COM Yardage: 1 or 2 seats: .75 yard Contact Leland Customer Experience for yardage requirements on textiles with repeats. Optional Glides: Add \$8.00 net per chair for a set of four (4).													



<b>Slam Sled Base Chair</b>	<b>MODEL</b>	<b>FRAME FINISH</b>	<b>LIST PRICE</b>
3D Oak veneer shell	SLS-3D0	Powder Coat	\$1255
W 22.5 D 20.75 H 31.75 SH 18		Chrome	\$1324



<b>Slam Sled Base Chair</b>	<b>MODEL</b>	<b>LIST PRICE/ GRADE</b>	<b>COM/COL</b>	<b>A</b>	<b>B</b>	<b>C</b>	<b>D</b>	<b>E</b>	<b>F</b>	<b>G</b>	<b>H</b>	<b>I</b>	<b>J</b>	<b>K</b>	<b>L</b>
3D Oak veneer shell, upholstered seat onlay	SLS-30U	Powder Coat	\$1404	1472	1508	1542	1578	1613	1647	1683	1718	1754	1789	1824	1859
		Chrome	\$1469	1539	1574	1610	1644	1679	1715	1749	1784	1821	1855	1891	1926
W 22.5 D 20.75 H 31.75 SH 18.25		COM Yardage: 1 or 2 seats: .75 yard Contact Leland Customer Experience for yardage requirements on textiles with repeats. Optional Glides: Add \$8.00 net per chair for a set of four (4).													

**To specify:**  
 Please refer to pages 3-4 for complete specifying information.  
 Specify all products by their product code.

**SLAM 4-LEG BASE CHAIR**  
 Design: Lievore Altherr Molina, licensed by Sellex

**SL7**



**Slam Stacking**

**4-Leg Base Chair**

	MODEL	FRAME FINISH	LIST PRICE
Polypropylene shell	SL4-PO	Powder Coat	\$483
W 20.75 D 19.75 H 31 SH 18		Chrome	\$551

Optional Glides: Add \$8.00 net per chair for a set of four (4). Optional Glides raise chair height .5 inch.



**Slam Stacking**

**4-Leg Base Chair**

	MODEL	LIST PRICE/GRADE	COM/COL	A	B	C	D	E	F	G	H	I	J	K	L
Polypropylene shell, upholstered seat onlay	SL4-PU	Powder Coat	\$657	726	761	796	832	867	902	938	972	1007	1043	1077	1112
		Chrome	\$726	795	830	865	901	937	971	1006	1042	1076	1111	1147	1182

W 20.75 D 19.75 H 31 SH 18.25

Optional Glides: Add \$8.00 net per chair for a set of four (4). Optional Glides raise chair height .5 inch.

COM Yardage: 1 or 2 seats: .75 yard

Contact Leland Customer Experience for yardage requirements on textiles with repeats.

For COL requirements please contact Leland Customer Experience.



**Slam Stacking**

**4-Leg Base Chair**

	MODEL	LIST PRICE/GRADE	COM/COL	A	B	C	D	E	F	G	H	I	J	K	L
Fully upholstered	SL4-FU	Powder Coat	\$732	854	915	976	1037	1098	1159	1220	1281	1342	1403	1464	1525
		Chrome	\$800	922	983	1044	1105	1166	1227	1288	1349	1410	1471	1532	1593

W 20.75 D 19.75 H 31 SH 18.25

Optional Glides: Add \$8.00 net per chair for a set of four (4). Optional Glides raise chair height .5 inch.

COM Yardage: 1 seat: 1.5 yards

Contact Leland Customer Experience for yardage requirements on textiles with repeats.

For COL requirements please contact Leland Customer Experience.

To specify:

Please refer to pages 3-4 for complete specifying information.

Specify all products by their product code.

Pricing Effective: January 2023

**SLAM 4-LEG BASE CHAIR**  
 Design: Lievore Altherr Molina, licensed by Sellex

**SL8**



**Slam Stacking  
 4-Leg Base Chair**

	MODEL	FRAME FINISH	LIST PRICE
3D Beech veneer shell	SL4-3DB	Powder Coat	\$1103
W 20.75 D 19.75 H 31 SH 18		Chrome	\$1172

Optional Glides: Add \$8.00 net per chair for a set of four (4). Optional Glides raise chair height .5 inch.



**Slam Stacking  
 4-Leg Base Chair**

	MODEL	LIST PRICE/ GRADE	COM/COL	A	B	C	D	E	F	G	H	I	J	K	L
3D Beech veneer shell, upholstered seat onlay	SL4-3BU	Powder Coat	\$1275	1345	1379	1416	1451	1487	1521	1556	1592	1626	1661	1698	1732
		Chrome	\$1346	1416	1451	1487	1521	1556	1592	1626	1661	1698	1732	1767	1803

W 20.75 D 19.75 H 31 SH 18.25

Optional Glides: Add \$8.00 net per chair for a set of four (4). Optional Glides raise chair height .5 inch.  
 COM Yardage: 1 or 2 seats: .75 yard  
 Contact Leland Customer Experience for yardage requirements on textiles with repeats.  
 For COL requirements please contact Leland Customer Experience.



**Slam Stacking  
 4-Leg Base Chair**

	MODEL	FRAME FINISH	LIST PRICE
3D Oak veneer shell	SL4-3D0	Powder Coat	\$1275
W 20.75 D 19.75 H 31 SH 18		Chrome	\$1342

Optional Glides: Add \$8.00 net per chair for a set of four (4). Optional Glides raise chair height .5 inch.



**Slam Stacking  
 4-Leg Base Chair**

	MODEL	LIST PRICE/ GRADE	COM/COL	A	B	C	D	E	F	G	H	I	J	K	L
3D Oak veneer shell, upholstered seat onlay	SL4-30U	Powder Coat	\$1448	1517	1552	1586	1622	1657	1691	1727	1762	1797	1833	1868	1903
		Chrome	\$1518	1586	1622	1657	1691	1727	1762	1797	1833	1868	1903	1938	1973

W 20.75 D 19.75 H 31 SH 18.25

Optional Glides: Add \$8.00 net per chair for a set of four (4). Optional Glides raise chair height .5 inch.  
 COM Yardage: 1 or 2 seats: .75 yard  
 Contact Leland Customer Experience for yardage requirements on textiles with repeats.  
 For COL requirements please contact Leland Customer Experience.

**To specify:**  
 Please refer to pages 3-4 for complete specifying information.  
 Specify all products by their product code.

**SLAM STACKING ARM CHAIR, 4-LEG BASE**  
 Design: Lievore Altherr Molina, licensed by Sellex

**SL9**



**Slam Stacking Arm Chair**

**4-Leg Base**

	MODEL	FRAME FINISH	LIST PRICE
Polypropylene shell	SL4A-PO	Powder Coat	\$633
W 25 D 20.75 H 31.75 SH 18 AH 25.5		Chrome with powder coat arm cap	\$701



**Slam Stacking Arm Chair**

**4-Leg Base**

	MODEL	LIST PRICE/GRADE	COM/COL	A	B	C	D	E	F	G	H	I	J	K	L
Polypropylene shell upholstered seat onlay	SL4A-PU	Powder Coat	\$780	848	884	919	954	990	1025	1060	1095	1130	1165	1200	1235
		Chrome with powder coat arm cap	\$848	918	952	988	1024	1059	1094	1129	1164	1199	1234	1269	1305
W 25 D 20.75 H 31.75 SH 18.25 AH 25.5		COM Yardage: 1 or 2 seats: .75 yard Contact Leland Customer Experience for yardage requirements on textiles with repeats.													



**Slam Stacking Arm Chair**

**4-Leg Base**

	MODEL	LIST PRICE/GRADE	COM/COL	A	B	C	D	E	F	G	H	I	J	K	L
Fully upholstered	SL4A-FU	Powder Coat	\$855	977	1038	1099	1160	1221	1282	1343	1404	1465	1526	1587	1648
W 25 D 20.75 H 31.75 SH 18.25 AH 25.5		Chrome with powder coat arm cap	\$923	1045	1106	1167	1228	1289	1350	1411	1472	1533	1594	1655	1716
		COM Yardage: 1 Seat: 1.5 yards Contact Leland Customer Experience for yardage requirements on textiles with repeats.													

To specify:

Please refer to pages 3-4 for complete specifying information. Specify all products by their product code.

Pricing Effective: January 2023

**SLAM STACKING ARM CHAIR, 4-LEG BASE**  
 Design: Lievore Altherr Molina, licensed by Sellex

**SL10**



**Slam Stacking Arm Chair**

**4-Leg Base**

	MODEL	FRAME FINISH	LIST PRICE
3D Beech veneer shell	SL4A-3DB	Powder Coat	\$1253
W 25 D 20.75 H 31.75 SH 18 AH 25.5		Chrome with powder coat arm cap	\$1322



**Slam Stacking Arm Chair**

**4-Leg Base**

	MODEL	LIST PRICE/GRADE	COM/COL	A	B	C	D	E	F	G	H	I	J	K	L
3D Beech veneer shell, upholstered seat onlay	SL4A-3BU	Powder Coat	\$1398	1468	1502	1539	1574	1610	1644	1679	1715	1749	1784	1821	1855
W 25 D 20.75 H 31.75 SH 18.25 AH 25.5		Chrome with powder coat arm cap	\$1469	1539	1574	1610	1644	1679	1715	1749	1784	1821	1855	1890	1926

Optional Glides: Add \$8.00 net per chair for a set of four (4). Optional Glides raise chair height .5 inch.  
 COM Yardage: 1 or 2 seats: .75 yard  
 Contact Leland Customer Experience for yardage requirements on textiles with repeats.



**Slam Stacking Arm Chair**

**4-Leg Base**

	MODEL	FRAME FINISH	LIST PRICE
3D Oak veneer shell	SL4A-3DO	Powder Coat	\$1425
W 25 D 20.75 H 31.75 SH 18 AH 25.5		Chrome with powder coat arm cap	\$1492



**Slam Stacking Arm Chair**

**4-Leg Base**

	MODEL	LIST PRICE/GRADE	COM/COL	A	B	C	D	E	F	G	H	I	J	K	L
3D Oak veneer shell, upholstered seat onlay	SL4A-3OU	Powder Coat	\$1571	1640	1675	1709	1745	1780	1814	1850	1885	1920	1956	1991	2026
W 25 D 20.75 H 31.75 SH 18.25 AH 25.5		Chrome with powder coat arm cap	\$1641	1709	1745	1780	1814	1850	1885	1920	1956	1991	2026	2061	2096

Optional Glides: Add \$8.00 net per chair for a set of four (4). Optional Glides raise chair height .5 inch.  
 COM Yardage: 1 or 2 seats: .75 yard  
 Contact Leland Customer Experience for yardage requirements on textiles with repeats.

**To specify:**  
 Please refer to pages 3-4 for complete specifying information.  
 Specify all products by their product code.



**SLAM SIDE CHAIR, BEECH WOOD LEG**  
 Design: Lievore Altherr Molina, licensed by Sellex

**SL11**



<b>Slam Side Chair, Beech Wood Leg</b>	<b>MODEL</b>	<b>LIST PRICE</b>
Polypropylene shell, Beech Leg W 22.5 D 21.5 H 31 SH 18	SLW-PO	\$764



<b>Slam Side Chair, Beech Wood Leg</b>	<b>MODEL</b>	<b>COM/COL</b>	<b>A</b>	<b>B</b>	<b>C</b>	<b>D</b>	<b>E</b>	<b>F</b>	<b>G</b>	<b>H</b>	<b>I</b>	<b>J</b>	<b>K</b>	<b>L</b>
Polypropylene shell, Beech Leg upholstered seat onlay W 22.5 D 21.5 H 31 SH 18.25	SLW-PU	\$911	980	1015	1050	1085	1121	1156	1192	1226	1261	1297	1331	1366

COM Yardage: 1 or 2 seats: .75 yard  
 Contact Leland Customer Experience for yardage requirements on textiles with repeats.  
 For COL requirements please contact Leland Customer Experience.



<b>Slam Side Chair, Beech Wood Leg</b>	<b>MODEL</b>	<b>COM/COL</b>	<b>A</b>	<b>B</b>	<b>C</b>	<b>D</b>	<b>E</b>	<b>F</b>	<b>G</b>	<b>H</b>	<b>I</b>	<b>J</b>	<b>K</b>	<b>L</b>
Fully upholstered, Beech Leg W 22.5 D 21.5 H 31 SH 18.25	SLW-FU	\$986	1108	1169	1230	1291	1352	1413	1474	1535	1596	1657	1718	1779

COM Yardage: 1 seat: 1.5 yards  
 Contact Leland Customer Experience for yardage requirements on textiles with repeats.  
 For COL requirements please contact Leland Customer Experience.

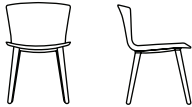

<b>Slam Side Chair, Beech Wood Leg</b>	<b>MODEL</b>	<b>LIST PRICE</b>
3D Beech veneer shell, Beech Leg W 22.5 D 21.5 H 31 SH 18	SLW-3DB	\$1423



<b>Slam Side Chair, Beech Wood Leg</b>	<b>MODEL</b>	<b>COM/COL</b>	<b>A</b>	<b>B</b>	<b>C</b>	<b>D</b>	<b>E</b>	<b>F</b>	<b>G</b>	<b>H</b>	<b>I</b>	<b>J</b>	<b>K</b>	<b>L</b>
3D Beech veneer shell, Beech Leg upholstered seat onlay W 22.5 D 21.5 H 31 SH 18.25	SLW-3BU	\$1610	1678	1714	1748	1783	1820	1854	1889	1925	1959	1995	2030	2064

COM Yardage: 1 or 2 seats: .75 yard  
 Contact Leland Customer Experience for yardage requirements on textiles with repeats.  
 For COL requirements please contact Leland Customer Experience.

**To specify:**  
 Please refer to pages 3-4 for complete specifying information.  
 Specify all products by their product code.

**Pricing Effective: January 2023**

**SLAM SIDE CHAIR, OAK WOOD LEG**  
 Design: Lievore Altherr Molina, licensed by Sellex

**SL12**

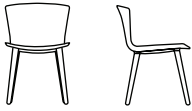

<b>Slam Side Chair, Oak Wood Leg</b>	<b>MODEL</b>	<b>LIST PRICE</b>
Polypropylene shell, Oak Leg W 22.5 D 21.5 H 31 SH 18	SLWO-PO	\$858



<b>Slam Side Chair, Oak Wood Leg</b>	<b>MODEL</b>	<b>COM/COL</b>	<b>A</b>	<b>B</b>	<b>C</b>	<b>D</b>	<b>E</b>	<b>F</b>	<b>G</b>	<b>H</b>	<b>I</b>	<b>J</b>	<b>K</b>	<b>L</b>
Polypropylene shell, Oak Leg upholstered seat onlay W 22.5 D 21.5 H 31 SH 18.25	SLWO-PU	\$1005	1074	1109	1144	1179	1215	1250	1286	1320	1355	1391	1425	1460
COM Yardage: 1 or 2 seats: .75 yard Contact Leland Customer Experience for yardage requirements on textiles with repeats. For COL requirements please contact Leland Customer Experience.														



<b>Slam Side Chair, Oak Wood Leg</b>	<b>MODEL</b>	<b>COM/COL</b>	<b>A</b>	<b>B</b>	<b>C</b>	<b>D</b>	<b>E</b>	<b>F</b>	<b>G</b>	<b>H</b>	<b>I</b>	<b>J</b>	<b>K</b>	<b>L</b>
Fully upholstered, Oak Leg W 22.5 D 21.5 H 31 SH 18.25	SLWO-FU	\$1080	1202	1263	1324	1385	1446	1507	1568	1629	1690	1751	1812	1873
COM Yardage: 1 seat: 1.5 yards Contact Leland Customer Experience for yardage requirements on textiles with repeats. For COL requirements please contact Leland Customer Experience.														



<b>Slam Side Chair, Oak Wood Leg</b>	<b>MODEL</b>	<b>LIST PRICE</b>
3D Oak veneer shell, Oak Leg W 22.5 D 21.5 H 31 SH 18	SLWO-3DO	\$1745



<b>Slam Side Chair, Oak Wood Leg</b>	<b>MODEL</b>	<b>COM/COL</b>	<b>A</b>	<b>B</b>	<b>C</b>	<b>D</b>	<b>E</b>	<b>F</b>	<b>G</b>	<b>H</b>	<b>I</b>	<b>J</b>	<b>K</b>	<b>L</b>
3D Oak veneer shell, Oak Leg upholstered seat onlay W 22.5 D 21.5 H 31 SH 18.25	SLWO-3OU	\$1960	2038	2079	2118	2159	2201	2240	2280	2322	2361	2402	2443	2482
COM Yardage: 1 or 2 seats: .75 yard Contact Leland Customer Experience for yardage requirements on textiles with repeats. For COL requirements please contact Leland Customer Experience.														

**To specify:**  
 Please refer to pages 3-4 for complete specifying information.  
 Specify all products by their product code.

**SLAM STACKING 4-LEG MOBILE BASE CHAIR**  
 Design: Lievore Altherr Molina, licensed by Sellex

**SL13**



**Slam Stacking**

**4-Leg Mobile Base Chair**

	MODEL	FRAME FINISH	LIST PRICE
Polypropylene shell w/ casters	SLM-PO	Powder Coat	\$763
W 20.75 D 19.75 H 31 .75 SH 18.25		Chrome	\$830



**Slam Stacking**

**4-Leg Mobile Base Chair**

	MODEL	LIST PRICE/ GRADE	COM/COL	A	B	C	D	E	F	G	H	I	J	K	L
Polypropylene shell, upholstered seat onlay, w/ casters	SLM-PU	Powder Coat	\$940	1008	1044	1078	1114	1150	1184	1220	1255	1289	1325	1360	1394
		Chrome	\$1004	1073	1108	1142	1178	1213	1250	1284	1319	1355	1389	1424	1460
W 20.75 D 19.75 H 31 .75 SH 18.5		COM Yardage: 1 or 2 seats: .75 yard Contact Leland Customer Experience for yardage requirements on textiles with repeats. For COL requirements please contact Leland Customer Experience.													



**Slam Stacking**

**4-Leg Mobile Base Chair**

	MODEL	LIST PRICE/ GRADE	COM/COL	A	B	C	D	E	F	G	H	I	J	K	L
Fully upholstered w/ casters	SLM-FU	Powder Coat	\$1012	1134	1195	1256	1317	1378	1439	1500	1561	1622	1683	1744	1805
		Chrome	\$1079	1201	1262	1323	1384	1445	1506	1567	1628	1689	1750	1811	1872
W 20.75 D 19.75 H 31 .75 SH 18.5		COM Yardage: 1 seat: 1.5 yards Contact Leland Customer Experience for yardage requirements on textiles with repeats. For COL requirements please contact Leland Customer Experience.													

To specify:

Please refer to pages 3-4 for complete specifying information.  
 Specify all products by their product code.

Pricing Effective: January 2023

**SLAM STACKING 4-LEG MOBILE BASE CHAIR**  
 Design: Lievore Altherr Molina, licensed by Sellex

**SL14**



**Slam Stacking**

**4-Leg Mobile Base Chair**

	MODEL	FRAME FINISH	LIST PRICE
3D Beech veneer shell w/ casters	SLM-3DB	Powder Coat	\$1383
W 20.75 D 19.75 H 31.75 SH 18.25		Chrome	\$1451



**Slam Stacking**

**4-Leg Mobile Base Chair**

	MODEL	LIST PRICE/ GRADE	COM/COL	A	B	C	D	E	F	G	H	I	J	K	L
3D Beech veneer shell, upholstered seat onlay, w/ casters	SLM-3BU	Powder Coat	\$1558	1627	1662	1699	1733	1769	1804	1838	1874	1909	1943	1980	2015
		Chrome	\$1625	1694	1730	1765	1800	1835	1870	1905	1940	1975	2010	2046	2082
W 20.75 D 19.75 H 31.75 SH 18.5		COM Yardage: 1 or 2 seats: .75 yard Contact Leland Customer Experience for yardage requirements on textiles with repeats. For COL requirements please contact Leland Customer Experience.													



**Slam Stacking**

**4-Leg Mobile Base Chair**

	MODEL	FRAME FINISH	LIST PRICE
3D Oak veneer shell w/ casters	SLM-3D0	Powder Coat	\$1555
W 20.75 D 19.75 H 31.75 SH 18.25		Chrome	\$1623



**Slam Stacking**

**4-Leg Mobile Base Chair**

	MODEL	LIST PRICE/ GRADE	COM/COL	A	B	C	D	E	F	G	H	I	J	K	L
3D Beech veneer shell, upholstered seat onlay, w/ casters	SLM-30U	Powder Coat	\$1730	1799	1834	1869	1904	1939	1974	2009	2045	2080	2115	2150	2186
		Chrome	\$1797	1867	1901	1937	1972	2007	2042	2077	2113	2148	2183	2218	2253
W 20.75 D 19.75 H 31.75 SH 18.5		CCOM Yardage: 1 or 2 seats: .75 yard Contact Leland Customer Experience for yardage requirements on textiles with repeats. For COL requirements please contact Leland Customer Experience.													

**To specify:**

**Please refer to pages 3-4 for complete specifying information. Specify all products by their product code.**

**SLAM STACKING MOBILE ARM CHAIR**  
 Design: Lievore Altherr Molina, licensed by Sellex

**SL15**



**Slam Stacking  
 Mobile Arm Chair**

	MODEL	FRAME FINISH	LIST PRICE
Polypropylene Shell w/ casters	SLMA-PO	Powder Coat	\$913

W 20.75 D 19.75 H 31 .75  
 SH 18.5



**Slam Stacking  
 Mobile Arm Chair**

	MODEL	LIST PRICE/ GRADE	COM/COL	A	B	C	D	E	F	G	H	I	J	K	L
Polypropylene shell, upholstered seat onlay, w/ casters	SLMA-PU	Powder Coat	\$1090	1158	1194	1228	1264	1300	1334	1370	1405	1439	1475	1510	1544

W 20.75 D 19.75 H 31 .75  
 SH 18.5

COM Yardage: 1 or 2 seats: .75 yard  
 Contact Leland Customer Experience for yardage requirements on textiles with repeats.  
 For COL requirements please contact Leland Customer Experience.



**Slam Stacking  
 Mobile Arm Chair**

	MODEL	LIST PRICE/ GRADE	COM/COL	A	B	C	D	E	F	G	H	I	J	K	L
Fully upholstered w/ casters	SLMA-FU	Powder Coat	\$1162	1284	1345	1406	1467	1528	1589	1650	1711	1772	1833	1894	1955

W 20.75 D 19.75 H 31 .75  
 SH 18.5

COM Yardage: 1 seat: 1.5 yards  
 Contact Leland Customer Experience for yardage requirements on textiles with repeats.  
 For COL requirements please contact Leland Customer Experience.

**To specify:**  
 Please refer to pages 3-4 for complete specifying information.  
 Specify all products by their product code.

**SLAM STACKING MOBILE ARM CHAIR**  
 Design: Lievore Altherr Molina, licensed by Sellex

**SL16**



**Slam Stacking  
 Mobile Arm Chair**

	MODEL	FRAME FINISH	LIST PRICE
3D Beech veneer shell w/ casters	SLMA-3DB	Powder Coat	\$1533

W 20.75 D 19.75 H 31.75  
 SH 18.25



**Slam Stacking  
 Mobile Arm Chair**

	MODEL	LIST PRICE/ GRADE	COM/COL	A	B	C	D	E	F	G	H	I	J	K	L
3D Beech veneer shell, upholstered seat onlay, w/ casters	SLMA-3BU	Powder Coat	\$1708	1777	1812	1849	1883	1919	1954	1988	2024	2059	2093	2130	2165

COM Yardage: 1 or 2 seats: .75 yard  
 Contact Leland Customer Experience for yardage requirements on textiles with repeats.  
 For COL requirements please contact Leland Customer Experience.

W 20.75 D 19.75 H 31.75  
 SH 18.5



**Slam Stacking  
 Mobile Arm Chair**

	MODEL	FRAME FINISH	LIST PRICE
3D Oak veneer shell w/ casters	SLMA-3DO	Powder Coat	\$1705

W 20.75 D 19.75 H 31.75  
 SH 18.25



**Slam Stacking  
 Mobile Arm Chair**

	MODEL	LIST PRICE/ GRADE	COM/COL	A	B	C	D	E	F	G	H	I	J	K	L
3D Beech veneer shell, upholstered seat onlay, w/ casters	SLMA-3DU	Powder Coat	\$1880	1949	1984	2019	2054	2089	2124	2159	2195	2230	2265	2300	2336

CCOM Yardage: 1 or 2 seats: .75 yard  
 Contact Leland Customer Experience for yardage requirements on textiles with repeats.  
 For COL requirements please contact Leland Customer Experience.

W 20.75 D 19.75 H 31.75  
 SH 18.5

**To specify:**  
 Please refer to pages 3-4 for  
 complete specifying information.  
 Specify all products by their  
 product code.

**SLAM SIDE CHAIR, ALUMINUM BASE**  
 Design: Lievore Altherr Molina, licensed by Sellex

**SL17**



**Slam Side Chair**

**Aluminum Base**

	MODEL	FRAME FINISH	LIST PRICE
Polypropylene shell	SLA-PO	Powder Coat	\$785
W 20.75 D 20.75 H 31.75 SH 18		Polished Aluminum	\$1382



**Slam Side Chair**

**Aluminum Base**

	MODEL	LIST PRICE/GRADE	COM/COL	A	B	C	D	E	F	G	H	I	J	K	L
Polypropylene shell upholstered seat onlay	SLA-PU	Powder Coat	\$933	1003	1038	1074	1109	1143	1179	1214	1248	1284	1319	1356	1390
		Polished Aluminum	\$1530	1599	1634	1671	1705	1740	1776	1810	1846	1881	1915	1952	1987

W 20.75 D 20.75  
H 31.75 SH 18.25

COM Yardage: 1 or 2 seats: .75 yard  
 Contact Leland Customer Experience for yardage requirements on textiles with repeats.



**Slam Side Chair**

**Aluminum Base**

	MODEL	LIST PRICE/GRADE	COM/COL	A	B	C	D	E	F	G	H	I	J	K	L
Fully upholstered	SLA-FU	Powder Coat	\$1007	1129	1190	1251	1312	1373	1434	1495	1556	1617	1678	1739	1800
		Polished Aluminum	\$1604	1726	1787	1848	1909	1970	2031	2092	2153	2214	2275	2336	2397

W 20.75 D 20.75  
H 31.75 SH 18.25

COM Yardage: 1 seat: 1.5 yards  
 Contact Leland Customer Experience for yardage requirements on textiles with repeats.

**To specify:**  
 Please refer to pages 3-4 for complete specifying information.  
 Specify all products by their product code.

**Pricing Effective: January 2023**

**SLAM SIDE CHAIR, ALUMINUM BASE**  
 Design: Lievore Altherr Molina, licensed by Sellex

**SL18**



**Slam Side Chair**

**Aluminum Base**

	MODEL	FRAME FINISH	LIST PRICE
3D Beech veneer shell, aluminum base	SLA-3DB	Powder Coat	\$1408
		Polished Aluminum	\$2002

W 20.75 D 20.75  
H 31.75 SH 18



**Slam Side Chair**

**Aluminum Base**

	MODEL	LIST PRICE/GRADE	COM/COL	A	B	C	D	E	F	G	H	I	J	K	L
3D Beech veneer shell, upholstered seat onlay, aluminum base	SLA-3BU	Powder Coat	\$1554	1623	1658	1693	1728	1763	1798	1833	1869	1904	1939	1974	2010
		Polished Aluminum	\$2149	2220	2254	2289	2325	2359	2394	2430	2464	2501	2536	2570	2606

W 20.75 D 20.75  
H 31.75 SH 18.25

Optional Glides: Add \$8.00 net per chair for a set of four (4). Optional Glides raise chair height .5 inch.  
 COM Yardage: 1 or 2 seats: .75 yard  
 Contact Leland Customer Experience for yardage requirements on textiles with repeats.



**Slam Side Chair**

**Aluminum Base**

	MODEL	FRAME FINISH	LIST PRICE
3D Oak veneer shell, aluminum base	SLA-3DO	Powder Coat	\$1579
		Polished Aluminum	\$2174

W 20.75 D 20.75  
H 31.75 SH 18



**Slam Side Chair**

**Aluminum Base**

	MODEL	LIST PRICE/GRADE	COM/COL	A	B	C	D	E	F	G	H	I	J	K	L
3D Oak veneer shell, upholstered seat onlay, aluminum base	SLA-3OU	Powder Coat	\$1724	1793	1828	1864	1898	1933	1970	2004	2040	2075	2109	2145	2180
		Polished Aluminum	\$2321	2390	2424	2460	2495	2531	2566	2601	2637	2671	2706	2742	2776

W 20.75 D 20.75  
H 31.75 SH 18.25

Optional Glides: Add \$8.00 net per chair for a set of four (4). Optional Glides raise chair height .5 inch.  
 COM Yardage: 1 or 2 seats: .75 yard  
 Contact Leland Customer Experience for yardage requirements on textiles with repeats.

**To specify:**

**Please refer to pages 3-4 for complete specifying information. Specify all products by their product code.**



**SLAM ARM CHAIR, ALUMINUM BASE**  
 Design: Lievore Altherr Molina, licensed by Sellex

**SL19**



**Slam Arm Chair**

**Aluminum Base**

	MODEL	FRAME FINISH	LIST PRICE
Polypropylene shell	SLAA-PO	Powder Coat	\$879
W 25 D 20.75 H 31.75 SH 18 AH 25.5		Polished Aluminum	\$1527



**Slam Arm Chair**

**Aluminum Base**

	MODEL	LIST PRICE/GRADE	COM/COL	A	B	C	D	E	F	G	H	I	J	K	L
Polypropylene shell upholstered seat onlay	SLAA-PU	Powder Coat	\$1026	1095	1130	1166	1200	1236	1272	1306	1342	1377	1411	1447	1482
		Polished Aluminum	\$1672	1740	1776	1810	1846	1881	1915	1952	1987	2021	2057	2092	2126

W 25 D 20.75 H 31.75  
SH 18.25 AH 25.5

COM Yardage: 1 or 2 seats: .75 yard  
 Contact Leland Customer Experience for yardage requirements on textiles with repeats.



**Slam Arm Chair**

**Aluminum Base**

	MODEL	LIST PRICE/GRADE	COM/COL	A	B	C	D	E	F	G	H	I	J	K	L
Fully upholstered	SLAA-FU	Powder Coat	\$1101	1223	1284	1345	1406	1467	1528	1589	1650	1711	1772	1833	1894
		Polished Aluminum	\$1749	1871	1932	1993	2054	2115	2176	2237	2298	2359	2420	2481	2542

W 25 D 20.75 H 31.75  
SH 18.25 AH 25.5

COM Yardage: 1.5 yards  
 Contact Leland Customer Experience for yardage requirements on textiles with repeats.

To specify:

Please refer to pages 3-4 for complete specifying information.  
 Specify all products by their product code.

Pricing Effective: January 2023

**SLAM ARM CHAIR, ALUMINUM BASE**  
 Design: Lievore Altherr Molina, licensed by Sellex

**SL20**



**Slam Arm Chair**

Aluminum Base	MODEL	FRAME FINISH	LIST PRICE
3D Beech veneer shell	SLAA-3DB	Powder Coat	\$1498
W 25 D 20.75 H 31.75 SH 18 AH 25.5		Polished Aluminum	\$2145



**Slam Arm Chair**

Aluminum Base	MODEL	LIST PRICE/GRADE	COM/COL	A	B	C	D	E	F	G	H	I	J	K	L
3D Beech veneer shell, upholstered seat onlay, aluminum base	SLAA-3BU	Powder Coat	\$1645	1715	1749	1784	1821	1855	1891	1926	1960	1996	2031	2065	2102
		Polished Aluminum	\$2292	2360	2396	2431	2466	2502	2537	2571	2607	2642	2676	2712	2747

W 25 D 20.75 H 31.75  
SH 18.25 AH 25.5

Optional Glides: Add \$8.00 net per chair for a set of four (4). Optional Glides raise chair height .5 inch.  
 COM Yardage: 1 or 2 seats: .75 yard  
 Contact Leland Customer Experience for yardage requirements on textiles with repeats.



**Slam Arm Chair**

Aluminum Base	MODEL	FRAME FINISH	LIST PRICE
3D Oak veneer shell, aluminum base	SLAA-3DO	Powder Coat	\$1671
W 25 D 20.75 H 31.75 SH 18 AH 25.5		Polished Aluminum	\$2314



**Slam Arm Chair**

Aluminum Base	MODEL	LIST PRICE/GRADE	COM/COL	A	B	C	D	E	F	G	H	I	J	K	L
3D Oak veneer shell, upholstered seat onlay, aluminum base	SLAA-3OU	Powder Coat	\$1817	1886	1922	1956	1991	2027	2061	2096	2132	2166	2203	2238	2272
		Polished Aluminum	\$2462	2532	2567	2602	2638	2672	2707	2743	2777	2813	2849	2883	2919

W 25 D 20.75 H 31.75  
SH 18.25 AH 25.5

Optional Glides: Add \$8.00 net per chair for a set of four (4). Optional Glides raise chair height .5 inch.  
 COM Yardage: 1 or 2 seats: .75 yard  
 Contact Leland Customer Experience for yardage requirements on textiles with repeats.

**To specify:**  
 Please refer to pages 3-4 for complete specifying information.  
 Specify all products by their product code.

**SLAM TASK BASE CHAIR**  
 Design: Lievore Altherr Molina, licensed by Sellex

**SL21**

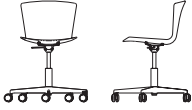

<b>Slam Task Base Chair</b>	<b>MODEL</b>	<b>FRAME FINISH</b>	<b>LIST PRICE</b>
Polypropylene shell	SLTB-PO	Powder Coat	\$885

W 20.75 D 20.75  
 H 31.75-35.75 SH 18.5-22.5

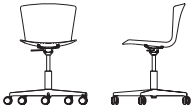

<b>Slam Task Base Chair</b>	<b>MODEL</b>	<b>LIST PRICE/GRADE</b>	<b>COM/COL</b>	<b>A</b>	<b>B</b>	<b>C</b>	<b>D</b>	<b>E</b>	<b>F</b>	<b>G</b>	<b>H</b>	<b>I</b>	<b>J</b>	<b>K</b>	<b>L</b>
Polypropylene shell, upholstered seat onlay	SLTB-PU	Powder Coat	\$1031	1075	1096	1118	1140	1162	1183	1206	1227	1248	1272	1293	1315

W 20.75 D 20.75  
 H 31.75-35.75 SH 18.5-22.5

COM Yardage: 1 or 2 seats: .75 yard  
 Contact Leland Customer Experience for yardage requirements on textiles with repeats.

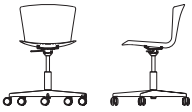

<b>Slam Task Base Chair</b>	<b>MODEL</b>	<b>LIST PRICE/GRADE</b>	<b>COM/COL</b>	<b>A</b>	<b>B</b>	<b>C</b>	<b>D</b>	<b>E</b>	<b>F</b>	<b>G</b>	<b>H</b>	<b>I</b>	<b>J</b>	<b>K</b>	<b>L</b>
Fully upholstered	SLTB-FU	Powder Coat	\$1107	1229	1290	1351	1412	1473	1534	1595	1656	1717	1778	1839	1900

W 20.75 D 20.75  
 H 31.75-35.75 SH 18.5-22.5

COM Yardage: 1 seat: 1.5 yards  
 Contact Leland Customer Experience for yardage requirements on textiles with repeats.

**To specify:**  
 Please refer to pages 3-4 for complete specifying information.  
 Specify all products by their product code.

**SLAM TASK BASE CHAIR**  
 Design: Lievore Altherr Molina, licensed by Sellex

**SL22**

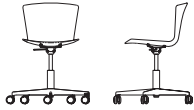

Slam Task Base Chair	MODEL	FRAME FINISH	LIST PRICE
3D Beech veneer shell	SLTB-3DB	Powder Coat	\$1505

W 20.75 D 20.75  
 H 31.75-35.75 SH 18.5-22.5



Slam Task Base Chair	MODEL	LIST PRICE/GRADE	COM/COL	A	B	C	D	E	F	G	H	I	J	K	L
3D Beech veneer shell, upholstered seat onlay	SLTB-3BU	Powder Coat	\$1654	1697	1718	1740	1762	1783	1806	1827	1849	1871	1893	1914	1937

W 20.75 D 20.75  
 H 31.75-35.75 SH 18.5-22.5

COM Yardage: 1 or 2 seats: .75 yard  
 Contact Leland Customer Experience for yardage requirements on textiles with repeats.



Slam Task Base Chair	MODEL	FRAME FINISH	LIST PRICE
3D Oak veneer shell	SLTB-3DO	Powder Coat	\$1675

W 20.75 D 20.75  
 H 31.75-35.75 SH 18.5-22.5



Slam Task Base Chair	MODEL	LIST PRICE/GRADE	COM/COL	A	B	C	D	E	F	G	H	I	J	K	L
3D Oak veneer shell, upholstered seat onlay	SLTB-3OU	Powder Coat	\$1824	1867	1889	1911	1932	1955	1976	1998	2020	2042	2063	2086	2107

W 20.75 D 20.75  
 H 31.75-35.75 SH 18.5-22.5

COM Yardage: 1 or 2 seats: .75 yard  
 Contact Leland Customer Experience for yardage requirements on textiles with repeats.

**To specify:**  
 Please refer to pages 3-4 for complete specifying information.  
 Specify all products by their product code.

**SLAM SLED COUNTER CHAIR**  
 Design: Lievore Altherr Molina, licensed by Sellex

**SL23**



**Slam Sled Counter Chair**

	MODEL	FRAME FINISH	LIST PRICE
Polypropylene shell	SLCS-PO	Powder Coat	\$707
W 22 D 20.75 H 39 SH 25		Chrome	\$785

Optional Glides: Add \$8.00 net per chair for a set of four (4).



**Slam Sled Counter Chair**

	MODEL	LIST PRICE/GRADE	COM/COL	A	B	C	D	E	F	G	H	I	J	K	L
Polypropylene shell, upholstered seat onlay,	SLCS-PU	Powder Coat	\$856	925	960	994	1030	1065	1099	1135	1170	1206	1241	1276	1311
		Chrome	\$933	1003	1038	1074	1109	1143	1179	1214	1248	1284	1319	1356	1390

W 22 D 20.75  
 H 39 SH 25.25

COM Yardage: 1 or 2 seats: .75 yard  
 Contact Leland Customer Experience for yardage requirements on textiles with repeats.  
 Optional Glides: Add \$8.00 net per chair for a set of four (4).



**Slam Sled Counter Chair**

	MODEL	LIST PRICE/GRADE	COM/COL	A	B	C	D	E	F	G	H	I	J	K	L
Fully upholstered	SLCS-FU	Powder Coat	\$929	1051	1112	1173	1234	1295	1356	1417	1478	1539	1600	1661	1722
		Chrome	\$1007	1129	1190	1251	1312	1373	1434	1495	1556	1617	1678	1739	1800

W 22 D 20.75  
 H 39 SH 25.25

COM Yardage: 1.5 yards  
 Contact Leland Customer Experience for yardage requirements on textiles with repeats.  
 Optional Glides: Add \$8.00 net per chair for a set of four (4).

**To specify:**  
 Please refer to pages 3-4 for complete specifying information.  
 Specify all products by their product code.

**Pricing Effective: January 2023**

**SLAM SLED COUNTER CHAIR**  
 Design: Lievore Altherr Molina, licensed by Sellex

# SL24



**Slam Sled**

Counter Chair	MODEL	FRAME FINISH	LIST PRICE
3D Beech veneer shell	SLCS-3DB	Powder Coat	\$1328
W 22 D 20.75 H 39 SH 25		Chrome	\$1408

Optional Glides: Add \$8.00 net per chair for a set of four (4).



**Slam Sled**

Counter Chair	MODEL	LIST PRICE/GRADE	COM/COL	A	B	C	D	E	F	G	H	I	J	K	L
3D Beech veneer shell, upholstered seat onlay	SLCS-3BU	Powder Coat	\$1472	1541	1576	1612	1646	1682	1717	1752	1788	1823	1857	1893	1928
		Chrome	\$1554	1623	1658	1693	1728	1763	1798	1833	1869	1904	1939	1974	2010

W 22 D 20.75  
 H 39 SH 25.25

COM Yardage: 1 or 2 seats: .75 yard  
 Contact Leland Customer Experience for yardage requirements on textiles with repeats.  
 Optional Glides: Add \$8.00 net per chair for a set of four (4).



**Slam Sled**

Counter Chair	MODEL	FRAME FINISH	LIST PRICE
3D Oak veneer shell	SLCS-3DO	Powder Coat	\$1498
W 22 D 20.75 H 39 SH 25		Chrome	\$1579

Optional Glides: Add \$8.00 net per chair for a set of four (4).



**Slam Sled**

Counter Chair	MODEL	LIST PRICE/GRADE	COM/COL	A	B	C	D	E	F	G	H	I	J	K	L
3D Oak veneer shell, upholstered seat onlay	SLCS-3OU	Powder Coat	\$1643	1713	1747	1782	1818	1853	1888	1924	1958	1993	2029	2063	2099
		Chrome	\$1724	1793	1828	1864	1898	1933	1970	2004	2040	2075	2109	2145	2180

W 22 D 20.75  
 H 39 SH 25.25

COM Yardage: 1 or 2 seats: .75 yard  
 Contact Leland Customer Experience for yardage requirements on textiles with repeats.  
 Optional Glides: Add \$8.00 net per chair for a set of four (4).

**To specify:**  
 Please refer to pages 3-4 for complete specifying information.  
 Specify all products by their product code.

**SLAM 4-LEG COUNTER CHAIR**  
 Design: Lievore Altherr Molina, licensed by Sellex

**SL25**



**Slam 4-Leg Counter Chair**

	MODEL	FRAME FINISH	LIST PRICE
Polypropylene shell	SLC4-PO	Powder Coat	\$924
W 22 D 19.75 H 37 SH 25		Chrome	\$1000

Optional Glides: Add \$8.00 net per chair for a set of four (4). Optional Glides raise chair height .5 inch.



**Slam 4-Leg Counter Chair**

	MODEL	LIST PRICE/GRADE	COM/COL	A	B	C	D	E	F	G	H	I	J	K	L
Polypropylene shell, upholstered seat onlay	SLC4-PU	Powder Coat	\$1069	1139	1174	1210	1244	1279	1315	1349	1385	1421	1455	1491	1526
		Chrome	\$1148	1216	1252	1286	1322	1358	1392	1427	1463	1497	1533	1568	1603

W 22 D 19.75  
 H 37.25 SH 25.25

Optional Glides: Add \$8.00 net per chair for a set of four (4). Optional Glides raise chair height .5 inch.  
 COM Yardage: 1 or 2 seats: .75 yard  
 Contact Leland Customer Experience for yardage requirements on textiles with repeats.  
 For COL requirements please contact Leland Customer Experience.



**Slam 4-Leg Counter Chair**

	MODEL	LIST PRICE/GRADE	COM/COL	A	B	C	D	E	F	G	H	I	J	K	L
Fully upholstered	SLC4-FU	Powder Coat	\$1146	1268	1329	1390	1451	1512	1573	1634	1695	1756	1817	1878	1939
		Chrome	\$1222	1344	1405	1466	1527	1588	1649	1710	1771	1832	1893	1954	2015

W 22 D 19.75  
 H 37.25 SH 25.25

Optional Glides: Add \$8.00 net per chair for a set of four (4). Optional Glides raise chair height .5 inch.  
 COM Yardage: 1.5 yards  
 Contact Leland Customer Experience for yardage requirements on textiles with repeats.  
 For COL requirements please contact Leland Customer Experience.

**To specify:**  
 Please refer to pages 3-4 for complete specifying information.  
 Specify all products by their product code.

**SLAM 4-LEG COUNTER CHAIR**  
 Design: Lievore Altherr Molina, licensed by Sellex

**SL26**



**Slam 4-Leg Counter Chair**

	MODEL	FRAME FINISH	LIST PRICE
3D Beech veneer shell	SLC4-3DB	Powder Coat	\$1544
W 22 D 19.75 H 37 SH 25		Chrome	\$1620

Optional Glides: Add \$8.00 net per chair for a set of four (4). Optional Glides raise chair height .5 inch.



**Slam 4-Leg Counter Chair**

	MODEL	LIST PRICE/GRADE	COM/COL	A	B	C	D	E	F	G	H	I	J	K	L
3D Beech veneer shell, upholstered seat onlay	SLC4-3BU	Powder Coat	\$1689	1759	1793	1828	1864	1898	1933	1970	2004	2040	2075	2109	2145
		Chrome	\$1766	1836	1871	1907	1941	1976	2012	2046	2081	2118	2153	2188	2223

W 22 D 19.75  
 H 37.25 SH 25.25

Optional Glides: Add \$8.00 net per chair for a set of four (4). Optional Glides raise chair height .5 inch.  
 COM Yardage: 1 or 2 seats: .75 yard  
 Contact Leland Customer Experience for yardage requirements on textiles with repeats.  
 For COL requirements please contact Leland Customer Experience.



**Slam 4-Leg Counter Chair**

	MODEL	FRAME FINISH	LIST PRICE
3D Oak veneer shell	SLC4-3DO	Powder Coat	\$1715
W 22 D 19.75 H 37 SH 25		Chrome	\$1791

Optional Glides: Add \$8.00 net per chair for a set of four (4). Optional Glides raise chair height .5 inch.



**Slam 4-Leg Counter Chair**

	MODEL	LIST PRICE/GRADE	COM/COL	A	B	C	D	E	F	G	H	I	J	K	L
3D Oak veneer shell, upholstered seat onlay	SLC4-3OU	Powder Coat	\$1861	1929	1965	1999	2035	2071	2105	2140	2176	2210	2245	2281	2315
		Chrome	\$1939	2008	2043	2078	2114	2148	2183	2220	2254	2289	2325	2359	2394

W 22 D 19.75  
 H 37.25 SH 25.25

Optional Glides: Add \$8.00 net per chair for a set of four (4). Optional Glides raise chair height .5 inch.  
 COM Yardage: 1 or 2 seats: .75 yard  
 Contact Leland Customer Experience for yardage requirements on textiles with repeats.  
 For COL requirements please contact Leland Customer Experience.

**To specify:**  
 Please refer to pages 3-4 for complete specifying information.  
 Specify all products by their product code.



**SLAM SLED BAR CHAIR**  
 Design: Lievore Altherr Molina, licensed by Sellex

**SL27**



Slam Sled Bar Chair	MODEL	FRAME FINISH	LIST PRICE
Polypropylene shell  W 22 D 20.75 H 43 SH 30	SLBS-PO	Powder Coat	\$796
		Chrome	\$865

Optional Glides: Add \$8.00 net per chair for a set of four (4).



Slam Sled Bar Chair	MODEL	LIST PRICE/GRADE	COM/COL	A	B	C	D	E	F	G	H	I	J	K	L
Polypropylene shell, upholsteredseat onlay  W 22 D 20.75 H 43 SH 30.25	SLBS-PU	Powder Coat	\$885	956	990	1025	1061	1095	1130	1166	1200	1236	1272	1306	1342
		Chrome	\$953	1023	1058	1093	1128	1163	1198	1233	1268	1304	1339	1374	1409

COM Yardage: 1 or 2 seats: .75 yard  
 Contact Leland Customer Experience for yardage requirements on textiles with repeats.  
 Optional Glides: Add \$8.00 net per chair for a set of four (4).

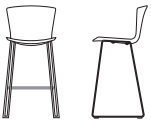

Slam Sled Bar Chair	MODEL	LIST PRICE/GRADE	COM/COL	A	B	C	D	E	F	G	H	I	J	K	L
Fully upholstered  W 22 D 20.75 H 43 SH 30.25	SLBS-FU	Powder Coat	\$1018	1140	1201	1262	1323	1384	1445	1506	1567	1628	1689	1750	1811
		Chrome	\$1087	1209	1270	1331	1392	1453	1514	1575	1636	1697	1758	1819	1880

COM Yardage: 1.5 yards  
 Contact Leland Customer Experience for yardage requirements on textiles with repeats.  
 Optional Glides: Add \$8.00 net per chair for a set of four (4).

**To specify:**  
 Please refer to pages 3-4 for complete specifying information.  
 Specify all products by their product code.

**Pricing Effective: January 2023**

**SLAM SLED BAR CHAIR**  
 Design: Lievore Altherr Molina, licensed by Sellex

**SL28**



Slam Sled Bar Chair	MODEL	FRAME FINISH	LIST PRICE
3D Beech veneer shell  W 22 D 20.75 H 43 SH 30	SLBS-3DB	Powder Coat	\$1416
		Chrome	\$1487

Optional Glides: Add \$8.00 net per chair for a set of four (4).



Slam Sled Bar Chair	MODEL	LIST PRICE/GRADE	COM/COL	A	B	C	D	E	F	G	H	I	J	K	L
3D Beech veneer shell, upholstered seat onlay  W 22 D 20.75 H 43 SH 30.25	SLBS-3BU	Powder Coat	\$1563	1632	1667	1703	1738	1773	1808	1843	1878	1913	1948	1983	2019
		Chrome	\$1746	1815	1850	1886	1922	1956	1991	2027	2061	2096	2132	2166	2203

COM Yardage: 1 or 2 seats: .75 yard  
 Contact Leland Customer Experience for yardage requirements on textiles with repeats.  
 Optional Glides: Add \$8.00 net per chair for a set of four (4).



Slam Sled Bar Chair	MODEL	FRAME FINISH	LIST PRICE
3D Oak veneer shell  W 22 D 20.75 H 43 SH 30	SLBS-3DO	Powder Coat	\$1588
		Chrome	\$1658

Optional Glides: Add \$8.00 net per chair for a set of four (4).



Slam Sled Bar Chair	MODEL	LIST PRICE/GRADE	COM/COL	A	B	C	D	E	F	G	H	I	J	K	L
3D Oak veneer shell, upholstered seat onlay  W 22 D 20.75 H 43 SH 30.25	SLBS-3OU	Powder Coat	\$1734	1804	1839	1873	1909	1944	1979	2014	2049	2085	2120	2155	2190
		Chrome	\$1575	1644	1679	1715	1749	1784	1821	1855	1891	1926	1960	1996	2031

COM Yardage: 1 or 2 seats: .75 yard  
 Contact Leland Customer Experience for yardage requirements on textiles with repeats.  
 Optional Glides: Add \$8.00 net per chair for a set of four (4).

**To specify:**  
 Please refer to pages 3-4 for complete specifying information.  
 Specify all products by their product code.

**SLAM 4-LEG BAR CHAIR**  
 Design: Lievore Altherr Molina, licensed by Sellex

**SL29**



Slam 4-Leg Bar Chair	MODEL	FRAME FINISH	LIST PRICE
Polypropylene shell	SLB4-PO	Powder Coat	\$942
W 22 D 19.75 H 43 SH 30		Chrome	\$1021
Optional Glides: Add \$8.00 net per chair for a set of four (4).			



Slam 4-Leg Bar Chair	MODEL	LIST PRICE/GRADE	COM/COL	A	B	C	D	E	F	G	H	I	J	K	L
Polypropylene shell, upholstered seat onlay	SLB4-PU	Powder Coat	\$1089	1157	1193	1227	1262	1298	1332	1367	1404	1439	1474	1509	1544
W 22 D 19.75 H 43.25 SH 30.25		Chrome	\$1166	1234	1269	1305	1341	1376	1410	1446	1481	1515	1551	1587	1621
Optional Glides: Add \$8.00 net per chair for a set of four (4). Optional Glides raise chair height .5 inch. COM Yardage: 1 or 2 seats: .75 yard Contact Leland Customer Experience for yardage requirements on textiles with repeats. For COL requirements please contact Leland Customer Experience.															



Slam 4-Leg Bar Chair	MODEL	LIST PRICE/GRADE	COM/COL	A	B	C	D	E	F	G	H	I	J	K	L
Fully upholstered	SLB4-FU	Powder Coat	\$1164	1286	1347	1408	1469	1530	1591	1652	1713	1774	1835	1896	1957
W 22 D 19.75 H 43.25 SH 30.25		Chrome	\$1243	1365	1426	1487	1548	1609	1670	1731	1792	1853	1914	1975	2036
Optional Glides: Add \$8.00 net per chair for a set of four (4). Optional Glides raise chair height .5 inch. COM Yardage: 1.5 yards Contact Leland Customer Experience for yardage requirements on textiles with repeats. For COL requirements please contact Leland Customer Experience.															

**To specify:**  
 Please refer to pages 3-4 for complete specifying information.  
 Specify all products by their product code.

# SLAM SLED BAR CHAIR

Design: Lievore Altherr Molina, licensed by Sellex

# SL30



Slam 4-Leg Bar Chair	MODEL	FRAME FINISH	LIST PRICE
3D Beech veneer shell  W 22 D 19.75 H 43 SH 30	SLB4-3DB	Powder Coat	\$1559
		Chrome	\$1639

Optional Glides: Add \$8.00 net per chair for a set of four (4). Optional Glides raise chair height .5 inch.



Slam 4-Leg Bar Chair	MODEL	LIST PRICE/GRADE	COM/COL	A	B	C	D	E	F	G	H	I	J	K	L
3D Beech veneer shell, upholstered seat onlay  W 22 D 19.75 H 43.25 SH 30.25	SLB4-3BU	Powder Coat	\$1709	1779	1813	1849	1884	1920	1955	1990	2025	2060	2095	2130	2165
		Chrome	\$1787	1855	1891	1926	1960	1996	2031	2065	2102	2137	2171	2207	2242

Optional Glides: Add \$8.00 net per chair for a set of four (4). Optional Glides raise chair height .5 inch.  
COM Yardage: 1 or 2 seats: .75 yard  
Contact Leland Customer Experience for yardage requirements on textiles with repeats.  
For COL requirements please contact Leland Customer Experience.



Slam 4-Leg Bar Chair	MODEL	FRAME FINISH	LIST PRICE
3D Oak veneer shell  W 22 D 19.75 H 43 SH 30	SLB4-3DO	Powder Coat	\$1731
		Chrome	\$1809

Optional Glides: Add \$8.00 net per chair for a set of four (4). Optional Glides raise chair height .5 inch.



Slam 4-Leg Bar Chair	MODEL	LIST PRICE/GRADE	COM/COL	A	B	C	D	E	F	G	H	I	J	K	L
3D Oak veneer shell, upholstered seat onlay  W 22 D 19.75 H 43.25 SH 30.25	SLB4-3OU	Powder Coat	\$1881	1950	1986	2020	2056	2091	2125	2161	2196	2230	2266	2302	2337
		Chrome	\$1957	2027	2061	2096	2132	2166	2203	2238	2272	2308	2343	2377	2413

Optional Glides: Add \$8.00 net per chair for a set of four (4). Optional Glides raise chair height .5 inch.  
COM Yardage: 1 or 2 seats: .75 yard  
Contact Leland Customer Experience for yardage requirements on textiles with repeats.  
For COL requirements please contact Leland Customer Experience..

**To specify:**  
Please refer to pages 3-4 for complete specifying information.  
Specify all products by their product code.

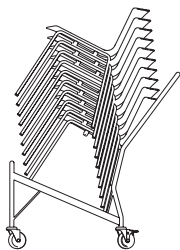

**Slam Transport/  
Stacking Dolly**

	MODEL	LIST PRICE
Black powder coat finish	SLD	\$2031
W 25 D 41.25 H 42 (Dimensions of dolly when empty)		
W 26 D 45 H 55 (Dimensions with stack)		

Slam Transport/Stacking Dolly capacity:  
 4-Leg Base: 10 high on dolly (8 high on floor)  
 4-Leg Mobile Base: 8 high on dolly (4 high on floor)  
 \*\*Sled and Aluminum Base does not stack

To specify:  
 Please refer to pages 3-4 for complete specifying information.  
 Specify all products by their product code.

# SLAM LOUNGE CHAIR

Design: Lievore Altherr Molina, licensed by Sellex

# SL32



## Slam Lounge

### Sled Base

	MODEL	LIST PRICE/GRADE	COM/COL	A	B	C	D	E	F	G	H	I	J	K	L
Fully upholstered	SLL-S	Powder Coat	\$1191	1287	1340	1395	1448	1500	1553	1608	1661	1714	1767	1822	1874
W 27.5 D 27.5 H 30 SH 17		Chrome	\$1267	1364	1417	1470	1524	1577	1630	1683	1737	1791	1844	1896	1950

Optional Glides: Add \$8.00 net per chair for a set of four (4). Optional Glides raise chair height .5 inch.

COM Yardage: 1.75 yards per chair

Contact Leland Customer Experience for yardage requirements on textiles with repeats.

For COL requirements please contact Leland Customer Experience.



## Slam Lounge

### Pyramidal Base

	MODEL	LIST PRICE/GRADE	COM/COL	A	B	C	D	E	F	G	H	I	J	K	L
Fully upholstered	SLL-P	Powder Coat	\$1728	1825	1878	1932	1986	2038	2091	2145	2199	2252	2305	2358	2411
W 27.5 D 26 H 30 SH 17		Polished Aluminum	\$2385	2481	2533	2588	2641	2694	2747	2802	2855	2907	2960	3015	3068

Optional Glides: Add \$8.00 net per chair for a set of four (4). Optional Glides raise chair height .5 inch.

COM Yardage: 1.75 yards per chair

Contact Leland Customer Experience for yardage requirements on textiles with repeats.

For COL requirements please contact Leland Customer Experience.

To specify:

Please refer to pages 3-4 for complete specifying information.

Specify all products by their product code.

Pricing Effective: January 2023

---

**5695 Eagle Drive, SE  
Grand Rapids,  
Michigan 49512  
616-975-9260  
lelandfurniture.com**

# Valeri Seating

## January 2023 Price List





# Valeri

Table of Contents	VS2
Specification Information	VS3
Specification Example	VS4
Guest Chair, Lounge Chair, Settee	VS5

## Chair Model

---

DESCRIPTION	CODE
Valeri guest chair	VG
Valeri lounge chair	VL
Valeri settee	VS

## Frame Finish

---

DESCRIPTION	CODE
Brushed stainless steel	SS

## Upholstery Selection

---

Please refer to Leland Textile Program which features textiles and leathers from the following partners:

- Camira
- Carnegie
- CF Stinson
- Green Hides
- Maharam
- Unika Vaev

The complete grade list can be found at [lelandinternational.com/ecatalog](http://lelandinternational.com/ecatalog) or you can specify COM/COL. Due to the design of this product, it is recommended that all non pre-approved textile be tested for compatibility.

## Glides

---

Valeri glides are steel swivel with nylon bottom.

## Freight Note

---

Due to the size and nature of Valeri Seating, the Freight Program does not apply to this product. Please contact Customer Experience for a quote.

**Specifications required to create the product code**

- Model
- Frame Finish
- Upholstery Selection



**MODEL**

Valeri Lounge Chair (VL)

**FRAME FINISH**

Brushed Stainless Steel (SS)

**UPHOLSTERY SELECTION**

Enter upholstery grade, COM or COL. Grade J (J)





**Valeri Guest Chair**

	MODEL	LIST PRICE/ GRADE	COM/COL	A	B	C	D	E	F	G	H	I	J	K	L
W 21.5 D 23 H 29 SH 18 AH 24.5	VG		\$1614	1726	1784	1841	1898	1956	2013	2071	2128	2184	2242	2300	2356

COM Yardage: 1 or 2 chairs: 1.75 yards  
Contact Leland Customer Experience for yardage requirements on textiles with repeats.  
For COL requirements please contact Leland Customer Experience.

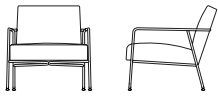

**Valeri Lounge Chair**

	MODEL	LIST PRICE/ GRADE	COM/COL	A	B	C	D	E	F	G	H	I	J	K	L
W 27.5 D 29.5 H 27 SH 15 AH 21	VL		\$2290	2452	2534	2616	2696	2777	2860	2941	3022	3104	3185	3268	3348

COM Yardage: 1 chair: 2.5 yards; 2 chairs: 3 yards; 3 or 4 chairs: 6 yards; 5 chairs: 6.5 yards  
Contact Leland Customer Experience for yardage requirements on textiles with repeats.  
For COL requirements please contact Leland Customer Experience.

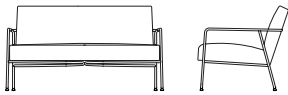

**Valeri Settee**

	MODEL	LIST PRICE/ GRADE	COM/COL	A	B	C	D	E	F	G	H	I	J	K	L
W 50 D 29.5 H 27 SH 15 AH 21	VS		\$3582	3907	4070	4233	4395	4558	4722	4885	5047	5210	5374	5537	5698

COM Yardage: 1 settee: 3 yards  
Due to upholstery requirements, Valeri Settee textile can only be upholstered railroaded.  
Please consider when specifying upholstery with a pattern or repeat.  
Contact Leland Customer Experience for yardage requirements on textiles with repeats.  
For COL requirements please contact Leland Customer Experience.

To specify:  
Please refer to pages 3-4 for complete specifying information.  
Specify all products by their product code.

---

**5695 Eagle Drive, SE**  
**Grand Rapids,**  
**Michigan 49512**  
**616-975-9260**  
**[lelandfurniture.com](http://lelandfurniture.com)**