



Product catalog

Commercial flooring and wall cladding systems since 1919

2021 edition

Designed for possibilities. Made for people.



Altro has been at the forefront of innovation for over 100 years. Today, working closely with architects, end customers, engineers, designers and contractors around the world, our insight and expertise help them transform everyday spaces into environments that can improve the well-being of everyone that uses them.

And by consistently turning creative thinking into practical, real-world solutions – that maintain the highest standards of safety and durability – Altro has become synonymous with quality.

As a family-founded business, we have a strong sense of what we value and a way of thinking inspired by The Bauhaus – a balance of quality, form and designed function – that puts people's needs at the heart of everything we do. It's a human-centered approach to designing for the demands of 21st century life.

It's a history that means we value the bold, the brave and the new. From focusing on how the different sectors we serve need their spaces to perform, to the call for more environmentally sustainable materials, Altro is constantly challenging what is possible and seeking new ways of inspiring our customers and answering their biggest challenges.

With offices across Europe, the Americas, Asia Pacific and the Middle East, we remain committed to developing solutions that stand the test of time.

We combine the best in contemporary style with the functionality required to improve the way we all live and work, wherever in the world that may be.

We are Altro.

01

welcome to Altro

Table of contents	1
Our sector expertise	2
The sectors we work in	4
Our sustainability story	8
Altro Easyclean	10

12

safety flooring

Why choose safety flooring?	14
Assess your slip risk	15
Measuring slip-resistance	16
Altro Stronghold 30	18
Altro Classic 25	20
Altro Atlas 40	22
Altro Aquarius	24
Technical chart	29

30

slip-resistant flooring

Why choose slip-resistant?	32
Altro Reliance 25	34
Altro Walkway 20	38
Altro Tungsten	42
Altro Promenade	44
Technical chart	47

48

adhesive-free flooring

Why choose adhesive-free?	50
Altro XpressLay	52
Altro Wood adhesive-free	56
Altro Cantata	58
Technical chart	63

64

smooth flooring

Why choose smooth flooring?	66
Altro Symphonia	68
Altro Operetta	72
Altro Orchestra	76
Altro Serenade	80
Altro Wood	82
Altro Wood Comfort	86
Altro Wood Acoustic	88
Altro Lavencia	90
Altro Quartz Tile	94
Altro Ollero rubber tile	98
Altro Dolce Tile	102
Technical chart	106

108

wall systems

Why choose Altro walls?	110
Our wall portfolio	111
Altro Whiterock	112
Integrated floors and walls	114
Altro Whiterock Matte	116
Altro Whiterock Chameleon	118
Altro Whiterock wall designs	120
Altro Whiterock PopArt	122
Altro Whiterock Digiclad	124
AW Imagination Wall	126
Altro Whiterock Whiteboard	128
AW Recessed Shelf	129
Altro Tegulis	130
Altro Puraguard	132
Technical chart	134

136

even more Altro

Floor accessories	138
Altro Whiterock accessories	142
Altro Puraguard accessories	145
Additional support	146
Installer training	148
Your education path	150



→
watch our new
corporate video
on altro.com

Our sector expertise

To work across multiple sectors requires real-world understanding: the ability to design for a purpose and address the challenges, issues and regulations for each industry, without ever compromising on quality or safety.

We bring a wealth of insight into every project – experience that keeps us at the forefront of design-led innovation – and a range of relevant products and unique solutions that not only help our customers realize their ambitions, but have the potential to transform everyday spaces into something special.

We invite you to discover some of our sectors, in brief, over the next few pages or on our website altro.com.

Sectors

- ☑ Healthcare
- ☑ Hospitality
- ☑ Senior living
- ☑ Manufacturing
- ☑ Education
- ☑ Food + drink production
- ☑ Housing
- ☑ Leisure
- ☑ Retail + offices
- ☑ Transport

To do list

- ☑ Place customers first
- ☑ Encourage collaboration - internal + external
- ☑ Value our customers + each other
- ☑ Create a culture of commitment
 - ☑ commit to performance
 - ☑ commit to Partnerships
 - ☑ commit to Possibilities
- ☑ Design and innovate floors and walls
 - ☑ fit for purpose
 - ☑ work across many sectors
 - ☑ address challenges + regulations
 - ☑ maintain safety + durability
- ☑ Share knowledge + insight with all
- ☑ provide products + solutions that turn everyday spaces into something special!



**real-world
understanding
through an
unrivaled
sector focus**



Healthcare

We've pioneered a range of solutions to give you the confidence to create the type of environment you really want. Whether it's a large hospital, care home or community healthcare center, you can provide inspirational rooms that don't just perform and look good, but also take hygiene and the safety of your people, patients and residents seriously.

Typical applications

- Hospitals
- Operating and surgical areas
- Emergency rooms
- Behavioral and mental health
- Patient rooms
- Patient restrooms
- Patient showers
- Corridors
- Kitchens
- Cafeterias
- Lobbies
- Administration offices

Recommended products (not inclusive)



Altro Symphonia



Altro Wood

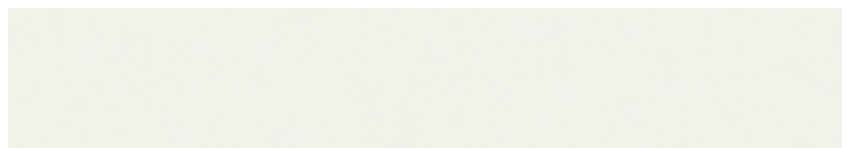

Altro Whiterock



Altro Whiterock PopArt



Hospitality

Whether it's a commercial kitchen, an office cafeteria, a five-star hotel or a chain of restaurants and cafes, safety, hygiene, ease and speed of installation and cost are all top priorities when designing for the hospitality sector.

Recommended products (not inclusive)

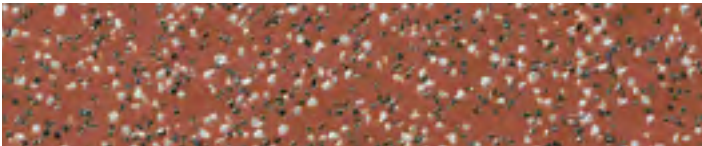

Altro Stronghold 30

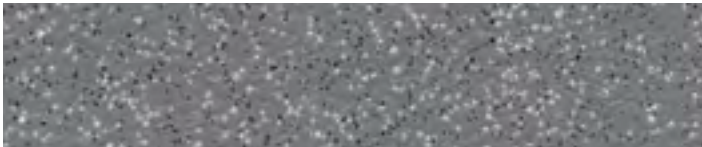

Altro Classic 25



Altro Puraguard



Senior living

It's vital to understand the many ways that aging affects health and the perceived physical environment. Interior finishes should be utilized that enhance the wellbeing of frail and aging residents.

Recommended products (not inclusive)



Altro Wood Comfort



Altro Orchestra

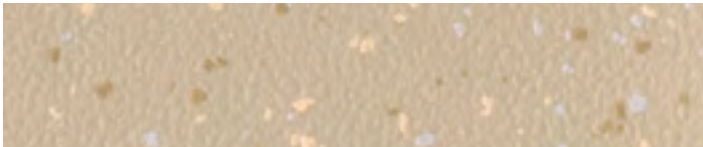

Altro Aquarius



Education

We believe that learning environments are some of the most important places there are, and the way they function is just as important as the way they look. Schools, colleges and universities need inspiring, durable, attractive and hygienic wall and flooring products that can cope with the demands of growing up.

Recommended products (not inclusive)



Altro Quartz Tile

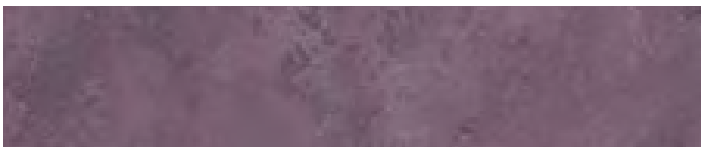

Altro Dolce Tile



Altro Lavencia LVT



Manufacturing

Materials specified for industrial and mass production areas are required to prioritize both durability and the wellbeing of everyone involved. These environments adhere to stringent health and safety guidelines that dictate nearly every aspect of their design.

Recommended products (not inclusive)



Altro Operetta



Altro Symphonia

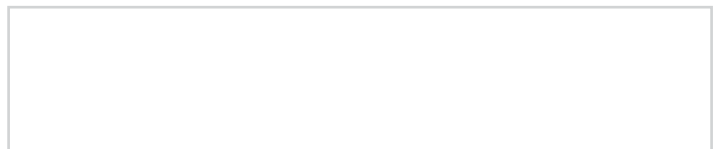

Altro Whiterock



Transport

Our Altro Transflor range of safety flooring is engineered to give you lightweight solutions without compromising on safety, durability, or ease of maintenance.



Housing

The way a home looks is just as important as how it functions. Welcoming, aesthetically pleasing, noise reducing finishes that are durable and easy to clean are a perfect solution for multi-family housing.



Retail + offices

How people feel when they're at work or when they shop with you can affect your business more than ever, especially if you don't have an environment people enjoy being in.



Prisons + defense

For containment and holding areas and walkways with heavy traffic, our products offer high strength, stain resistance and reduced dirt retention making them easy to clean and maintain.



Leisure

When your venues welcome masses of people every year, you need a robust floor and wall cladding solution, capable of doing exactly the right job in the right place.



Food + drink production

We know that a safe, efficient and hygienic facility is a vital part of the production process, which is why our specialized flooring and wall solutions are ideal.

Our sustainability story

Sustainability drives the choices we make. It starts with the raw materials we choose to go into our products; environmentally-friendly raw materials that enable us to produce phthalate-free vinyl flooring containing bio-plasticizers. Our commitment to sustainability made us the first manufacturer to recycle traditional safety flooring in-house and led to us being first to market 100% recyclable and reusable safety flooring post-installation - Altro XpressLay, which took the flooring industry by storm.

Taking responsibility

We recognize that sustainability is about being both environmentally and socially responsible, while also taking economic impact into account. So, as well as pioneering new recycling processes to reduce waste, we're also developing new initiatives based on customer feedback and needs — architects, interior designers, installers and end users. We're fully committed to honoring our environmental and social responsibilities, while continuing to provide our customers solutions that help create healthy living environments worldwide.

Resource efficiency

At our manufacturing base, we're committed to using resources efficiently and are actively reducing waste, energy and water consumption, and implementing closed-loop recycling processes. We've operated a zero-PVC-waste-to-landfill policy since 2014 by investing in, and installing, the world's first safety flooring recycling system. Altro is one of two founding members of Recofloor™ and Recowall™, the industry's first vinyl take-back programs that collect vinyl flooring off-cuts and wall cladding and divert them from going to landfill.

One of the core fundamentals of LEED is product transparency. Specifiers want to know which ingredients are in the products they use and if they are hazardous to human or environmental health. Altro supports this initiative and has our product transparency documents, EPDs and HPDs, publically available on our website.

Discover more at altro.com



LEED facts		 	
LEED v4		This product may help contribute to the following credits	
Altro floors		8	
	Materials and resources Contains recycled content	1	
	Materials and resources Renewable bio-based content	1	
	Materials and resources Environmental product declaration	1	
	Materials and resources Health product declaration	1	
	Environmental quality Low emitting materials, flooring	3	
	Environmental quality Low emitting materials, adhesives	1	

Discover more of our sustainability story and credentials at altro.com





Responsible manufacturing

Recycling

- Since 2007, we have sent zero-PVC-waste-to-landfill and have reduced our total waste at our factory to landfill by 70%.
- By including post-consumer and pre-consumer recycled content into our products, Altro is able to divert 900 tons of glass (wine bottles) and 500 tons of vinyl destined for landfills every year.
- Altro flooring comes in 100% recyclable packaging.

Water reduction

- Rain water capture systems have been installed on the roof of our manufacturing plant to reduce our use of potable water in our production process.
- We have achieved a 99% reduction in water consumption in our manufacturing process since 2000.

Open and honest transparency

Sustainable attributes of Altro products

- HPDs and EPDs are publicly available on altro.com
- Bio-based ingredients – our flooring products now include as much as 14% rapidly renewable, bio-based content.
- No heavy metals – contains no lead, cadmium, mercury, or hexavalent chromium.
- Phthalate-free – we do not use phthalates in the manufacture of products .
- Our bio-based plasticizer is responsibly sourced from maize in Europe.
- Recycled content – Altro safety flooring contains up to 20% recycled material.
- Altro sheet flooring complies with FloorScore certification as well as the CA 01350 and CDPH test methods. VOC emissions for Altro Whiterock have been found to be below detectable limits.
- Adhesives used to install Altro floor and wall products are also low VOC emitting and compliant.
- Off-cuts and scrap Altro flooring can be 100% recycled directly at our manufacturing facility.

How can Altro offer industry-leading cleanability and maintain underfoot safety?

Altro Easyclean™ Technology

Altro Easyclean Technology is unique in the marketplace as it is incorporated throughout the flooring while it is manufactured rather than applied as a surface finish. This allows Altro flooring to benefit from enhanced cleaning and maintenance while still allowing our products to maintain the slip-resistant properties Altro is known for.

The Altro Easyclean formula is matched to the floor during manufacturing to ensure slip resistance is a top priority in high slip risk areas. For example, smooth floors like Altro Cantata and Altro Symphonia will have more Altro Easyclean than a robust safety floor like Altro Stronghold 30.

Altro Easyclean offers

- Industry-leading ease of cleaning
- Enhanced long-term cleanability
- Cleaning and maintenance cost savings
- Sustained long-term slip resistance
- Exceptional long-term durability
- Low dirt pick-up qualities
- Improved color retention

How have we done it?

- Varying degrees of Altro Easyclean based on safety, slip-resistant and smooth flooring categories — adding a superficial PUR topcoat wouldn't be appropriate on a safety floor!
- Improved structure to prevent dirt retention around slip resistance particles, unlike conventional safety flooring and standard PURs.
- Incorporated Altro Easyclean throughout to ensure unparalleled performance for the life of the product.
- Slip-resistant particles throughout the product for guaranteed slip resistance, regardless of degree of wear.

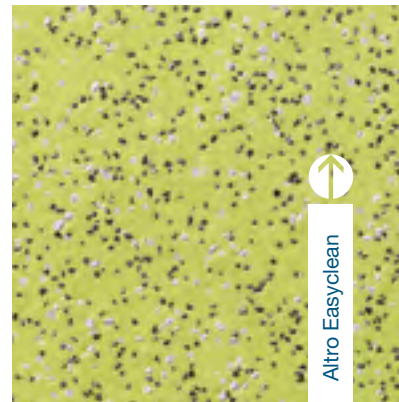

Safety flooring + level of Altro Easyclean



Slip-resistant flooring + level of Altro Easyclean

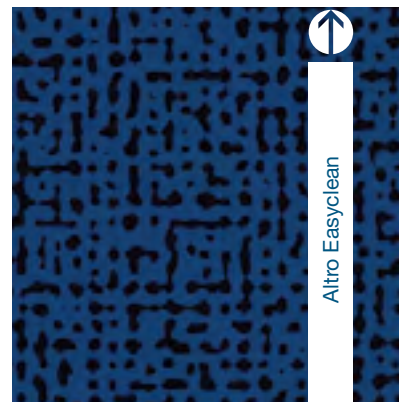

Smooth flooring + level of Altro Easyclean



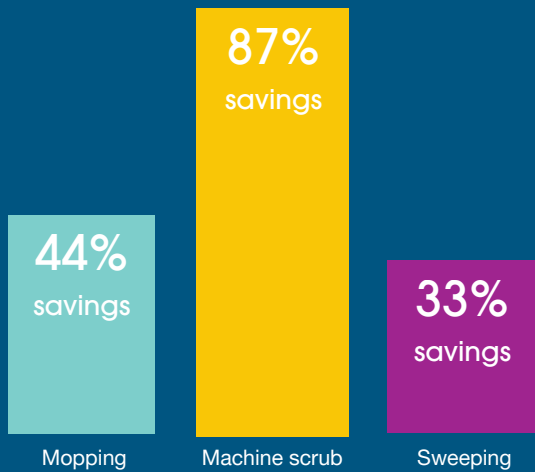

Maintenance cost savings analysis



Graph shows the percent saved with flooring treated with Altro Easyclean vs. a traditional non-PUR safety flooring. Percentages are based on a test area of 100m² over the span of one year. As most cleaning routines are a combination of manual mopping, machine scrubbing and sweeping, the average percentage saved when choosing a floor treated with Altro Easyclean may be up to 60% over its life cycle.

See below for an approximated cost breakdown. Testing was carried out by a third party independent

	Altro Easyclean treated floor	Non PUR treated competitor floor
Sweeping	\$8.27 - 5x week	\$12.41 - 5x week
Mopping	\$3.33 - 5x week	\$5.99 - 3x week
Machine scrub	\$1.29 - 1x month	\$10.26 - 2x week
15 year cost	\$10,054.31	\$22,329.39

Savings of \$820 year / \$12,275 over 15 year lifetime - 55%

Some facility managers find that they no longer require machine scrubbing with adequate manual cleaning programs and Altro Easyclean flooring. This increases savings further as shown below.

	Altro Easyclean treated floor	Non PUR treated competitor floor
Sweeping	\$8.27 - 5x week	\$12.41 - 5x week
Mopping	\$3.33 - 5x week	\$5.99 - 3x week
Machine scrub		\$10.26 - 2x week
15 year cost	\$9,048.00	\$22,329.39

Savings of \$887 year / \$13,281 over 15 year lifetime - 60%

Costs were accurate at the time of third party testing.

Dirt pick-up and color retention

Independent test findings, indicated on the graph below, show the level of dirt pick-up of Altro Easyclean compared with two competitor safety flooring products also containing a PUR treatment.

Test procedure and results

- The color of each safety flooring sample was recorded using a Chroma Meter II reflectance spectrophotometer.
- All samples were adhered to the inside of the Hexapod Tumbler to simulate normal wear conditions.
- The tumbler was automatically rotated for 30 mins.
- The safety flooring samples were removed.
- Each sample was vacuum cleaned after testing, before the degree of soiling was determined.
- Color brightness was re-measured in six random areas of each specimen to establish dirt pick-up and color retention.

Tests prove that flooring treated with Altro Easyclean picks up less dirt and therefore retains its color better and longer than competitor PUR treated safety flooring. Due to the patented surface construction of Altro flooring with Altro Easyclean, dirt does not collect around particles.

Loss of brightness test results

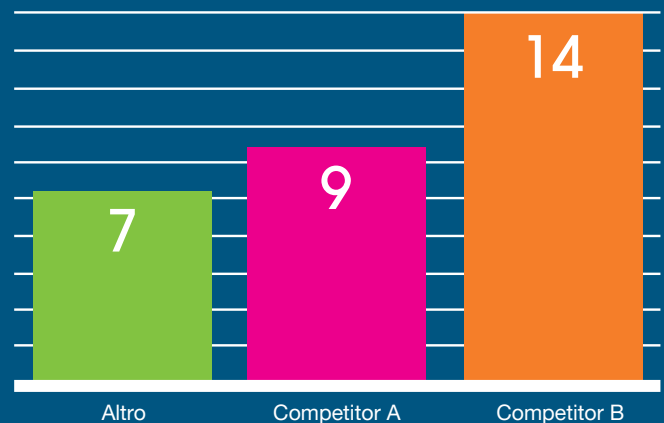

Figures above indicate the degree of soiling remaining on the sample. The lower the number, the better color retention.



Luxury resort, Miraval Berkshires, chose Altro Stronghold 30 Torch and Altro Puraguard Salt for much needed kitchen renovations.

safety flooring

Areas like busy commercial kitchens and wet environments have additional contaminants, which are continuously present, and spillages cannot be avoided. The likelihood of a slip is significantly increased, raising the slip risk level to *extremely high*. These locations, often riddled with contaminants such as grease, oil, shampoo and shower gels demand safety flooring that retains a slip risk of one-in-a-million.

Safety flooring

Why safety flooring?	14
Assess your slip-risk	15
Testing and measuring slip resistance	16
Safety product offerings	18
Technical chart	29

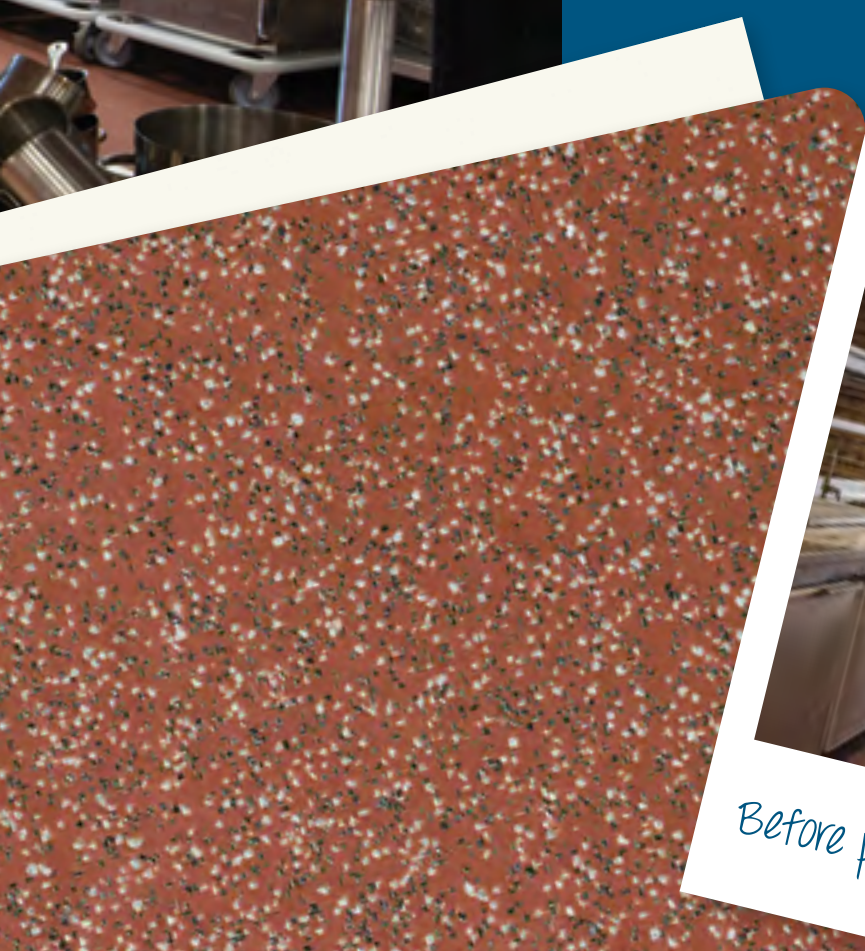

Before photo!

Why safety flooring?

Our safety flooring doesn't just protect the people who use it. It also protects those responsible for the health and safety of their employees and visitors. Our patented, aggregated construction of high-grade vinyl ensures a durable surface that is slip-resistant for the life of the floor.

Simply put, our slip resistance doesn't wear down like our competitors. Altro will maintain its integrity well past the warranty date. We've even tested flooring over 25 years old that still meets and exceeds today's measures.

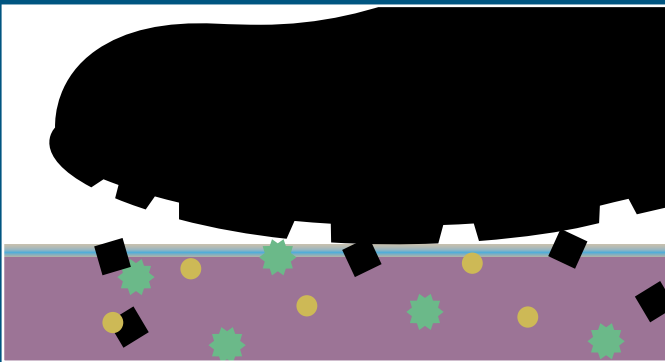

The pressure created by walking over safety flooring causes aggregates in the flooring to push up and rub against the shoe, creating friction. Because of this, Altro safety flooring remains slip-resistant, even when the surface profile is wet.

Typical safety applications

- Commercial kitchens
- Dishwashing areas
- Walk-in coolers and freezers
- Food and drink manufacturing
- Back-of-house and staff service areas
- Manufacturing and industrial areas
- Showers and bathing areas
- Areas adjacent to wet areas
- Areas requiring extreme durability
- Hydrotherapy pool + spa surrounds

When do you need safety flooring?

Assess your level of risk.

It is designers, specifiers and end-users' responsibility to ensure flooring is fit for purpose, and it's part of our role here at Altro to help make this process easy. Our flooring is separated into three categories: safety, slip-resistant and smooth. These categories have been created to help assist you in specifying the floor that is right for the application type and any contaminants that may be present on a regular basis.



Are contaminants present?

Areas that commonly see many contaminants such as oils, soaps, grease or constant spillages of water require extra care when selecting flooring. We recommend Altro safety flooring that meets R12 or R11 levels of slip resistance for these areas. General use areas that are not riddled with contaminants will be secure with our slip-resistant or smooth offerings.

Typical areas with contaminants:

- Commercial kitchens
- Dish washing area
- Food + beverage service
- Showers
- Locker rooms
- Hydrotherapy pool + spa surrounds
- Restrooms

Risk of slips	Altro R12 (Altro Stronghold 30)	Altro R11 (Altro Aquarius + Altro Classic 25)	Altro R10 (Slip-resistant floorings)
Water	1-in-a-million	1-in-a-million	1-in-a-million
Vegetable oil	1-in-a-million	1-in-100,000	1-in-20
Greasy water	1-in-a-million	1-in-100,000	1-in-20
Shower gel	1-in-a-million	1-in-a-million	1-in-20
Shampoo	1-in-a-million	1-in-a-million	1-in-20
Conditioner	1-in-a-million	1-in-a-million	1-in-20
Milk	1-in-a-million	1-in-a-million	1-in-a-million
Flour	1-in-a-million	1-in-a-million	1-in-a-million

By choosing wisely, you can reduce the risks of slips and falls as much as one-in-a-million.

Testing and measuring slip resistance

As the inventor of safety flooring, we take slip resistance seriously! Many manufacturers will develop flooring just to meet ADA or OSHA requirements, but at Altro, we go above and beyond what's legally required, to deliver safety flooring you can count on for the product's lifetime.

Our ranges are rigorously tested for slip resistance values using multiple techniques from around the globe.

We don't just meet existing test standards, we're raising the bar and pioneering new, rigorous testing protocols like the Pedatron test (shown right).

Static Coefficient of Friction ASTM D2047

**.92D
.88W**

A device called the James Machine pulls a small weighted sled over the floor surface. The result is the measurement of friction the surface creates. This is the accepted standard measure in North America.

While this standard only requires testing over dry conditions, at Altro we test our flooring in both dry and wet conditions. It's a pioneering approach that gives you complete peace of mind.

Dynamic Coefficient of Friction ANSI/NFSI B101.3-2012

**.74
DCOF**

Testing for the Dynamic Coefficient of Friction (DCoF) is conducted through the use of a Digital Tribometer.

The device passes five times in a certain direction over a designated test area for a combined total of 20 passes while collecting readings that measure slip resistance potential.

While other options are available, this is one of the most popular test methods in North America for measuring the Wet Dynamic Coefficient of Friction for common hard-surface floor materials.

TRRL Pendulum Test ASTM E303 / BS7976

**Pendulum test
PTV
≥55**

Popular in the UK, the pendulum test is the only portable test standard, allowing for on-site tests. The test incorporates a rubber shoe heel that sweeps over a set of flooring in a controlled manner and produces a pendulum value measuring the potential to slip.

A result of ≤ 25 is very high risk and a result of ≥ 36 and above is low risk. Altro safety flooring exceeds the ≥ 36 rating indicating the lowest potential for slip.

Ramp Test DIN 51130

R₁₂

This standard, popular in Europe, uses test subjects who walk backward and forward on an angled ramp in a controlled manner over a flooring sample contaminated with water, oil, or other liquids. Results are achieved when the test subject loses balance and falls, and those results are called an R value.

The range is from R9-R13, with R9 being the accepted minimum for use of tile in public areas.



This “Pedatron” machine gives an accurate representation of surface wear in situ. In hours we can reproduce months’ of pedestrian foot traffic. This allows us to test, and re-test slip resistance in intervals throughout the projected life span.

Altro Stronghold™ 30

1 in a
million
for Life

.92D
.88W

.74
DCOF

Pendulum test
PTV
≥55

R₁₂



Villa Laureana

Water underfoot is treacherous enough – add grease, oils and fats, and you’ve got a dangerous environment. For commercial kitchens, food preparation and back-of-house service areas, it’s essential to select flooring that will help staff continue their job safely.

Altro Stronghold 30 achieves Altro’s highest slip resistance rating and is designed to minimize risk in wet and greasy conditions for the lifetime of the flooring. In addition to keeping staff safe from slips, it also helps reduce their fatigue thanks to its 3mm thickness, providing ample noise reduction and comfort underfoot.

Typical applications

Commercial kitchens, food preparation, back-of-house service areas, walk-in coolers and freezers

Features + benefits

- Achieves highest level of slip resistance
- Risk of slipping is one-in-a-million even with contaminants present
- Heat-welded seams for better hygiene
- Static load limit exceeds 2000psi
- FDA / USDA / CFIA / HACCP compliant
- -22°F / -30°C lowest temperature rating
- Installs faster than quarry tile and epoxy
- Independent Halo tests indicate 10x lower bacteria count than quarry tile
- Fungi and mold-resistant, achieves zero growth after 28 days



Looks great with

- Altro Puraguard
- Altro Classic 25
- Altro Atlas 40
- Altro Lavencia
- Altro Wood
- all Altro wall cladding options



Sustainability

- 10% post-consumer recycled content
- O-phthalate free
- Contains bio-based content
- FloorScore certified and low VOC compliant
- Contributes to LEED

More content online www.altro.com



Samples

Experience has shown that printing cannot reproduce colors accurately. If color choice is critical, please request a sample of the material.

Samples are available on altro.com or through Material Bank.

Featured in image left



Abyss
K3001
WR100 / A1M100

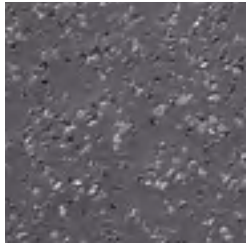

Cannon
K30911
WR101 / A1M72

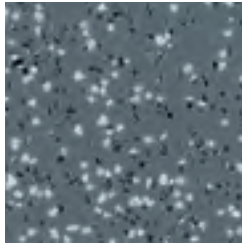

Dolphin
K3010
WR86 / A1M86

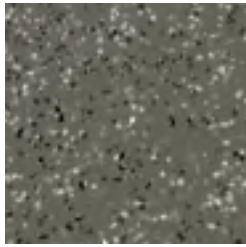

Tundra
K30500
WR153 / A1M239

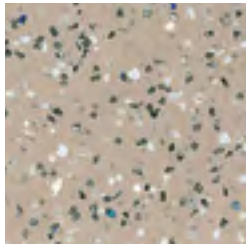

Biscuit
K30907
WR146 / A1M20

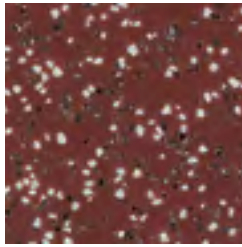

Russet
K30262
WR41 / A1M41

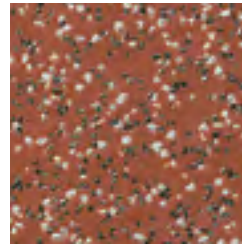

Torch
K30913
WR278 / A1M42

What do the codes under swatches mean?

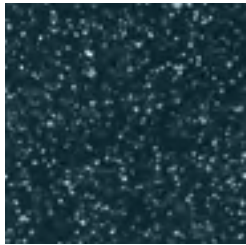

Midnight
K30421
WR72 / A1M72

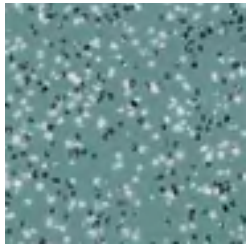

Skyline
K30332
WR52 / A1M52

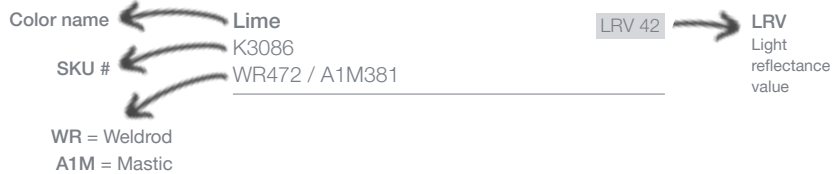
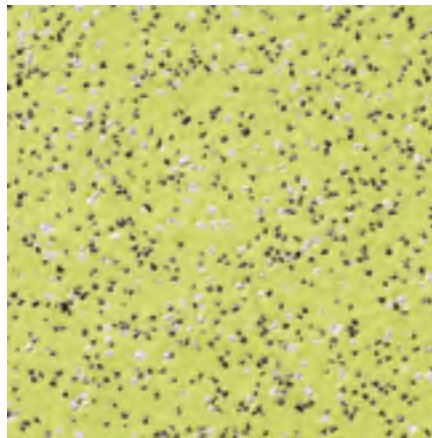

i **LRV = Light reflectance value**
Please keep LRVs in mind when selecting flooring for areas with dementia and Alzheimer's patients, seniors or individuals with poor vision.

i Color matched weldrods (WR) and mastics (A1M) are available. You'll find their product codes under product SKUs.



6'7" x 49' 2m x 15m
Format SHEET
Thickness 3mm .12"

Altro Classic™ 25

1 in a
million
for Life

.9D
1.0W

.60
DCOF

Planulum test
PTV
≥45

R11

Düsseldorf Exhibition Center Cafeteria



Classic by name, classic by nature – Altro Classic 25 was the first ever safety flooring. It has been tried and trusted for over 60 years, and its traditional, industrial look is still popular today.

Altro Classic 25 provides lasting slip resistance, durability and abrasion resistance, making it ideal for use in heavy traffic areas – particularly commercial kitchens.

Altro Classic 25 is easy to clean and maintain and is available in practical, dirt-hiding shades. It achieves an R11 slip resistance rating. Altro Stronghold 30 and Altro Atlas 40 are also great flooring options for commercial kitchens depending on your individual needs.

Typical applications

Food preparation and service areas, walk-in coolers, areas with heavy traffic



Looks great with

- Altro Puraguard
- Altro Stronghold 30
- Altro Atlas 40
- Altro Walkway 20
- Altro Lavencia
- Altro Wood
- all Altro wall cladding options



Sustainability

- 10% post-consumer recycled content
- O-phthalate free
- Contains bio-based content
- FloorScore certified and low VOC compliant
- Contributes to LEED

More content online www.altro.com



Samples

Experience has shown that printing cannot reproduce colors accurately. If color choice is critical, please request a sample of the material.

Samples are available on altro.com or through Material Bank.

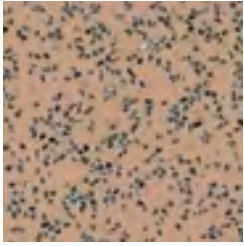

Mushroom LRV 32
X2542R11
WR24 / A1M27

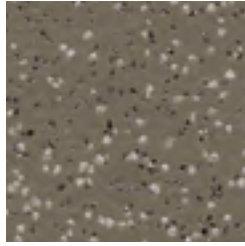

Truffle LRV 17
X2545R11
WR153 / A1M239

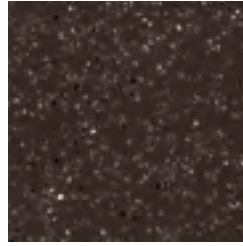

Walnut LRV 10
X2586R11
WR62 / A1M62

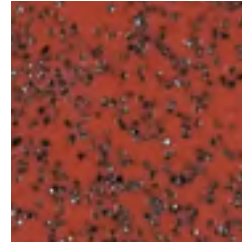

Quarry Red LRV 13
X2560R11
WR42 / A1M42

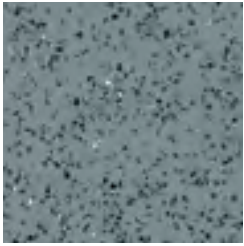

Pewter Grey LRV 26
X2539R11
WR81 / A1M81

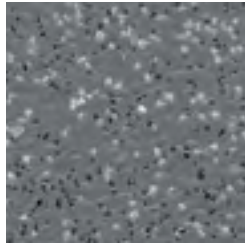

Graphite LRV 21
X2546R11
WR86 / A1M86

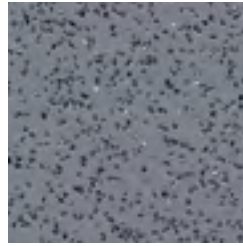

Whisper LRV 24
X2548R11
WR354 / A1M84

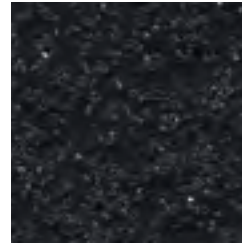

Blackberry LRV 7
X2547R11
WR100 / A1M100

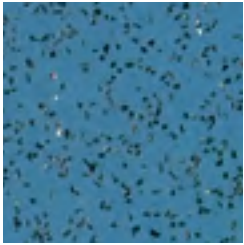

Blue LRV 20
X2541R11
WR71 / A1M71

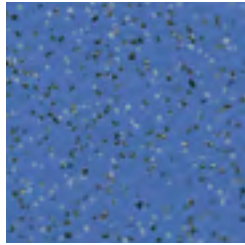

Aster LRV 17
X2549R11
WR286 / A1M286

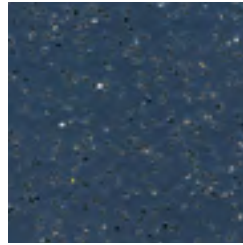

Legend LRV 10
X2544R11
WR231 / A1M73

Featured in image left



Anvil LRV 11
X2594R11
WR101 / A1M72



LRV = Light reflectance value

Please keep LRVs in mind when selecting flooring for areas with dementia and Alzheimer's patients, seniors or individuals with poor vision.



Color matched weldrods (WR) and mastics (A1M) are available. You'll find their product codes under product SKUs.



CEP/ISO 9001
PCF Global Services

6'7" x 65'5"
2m x 20m
Format SHEET
Thickness 2.5mm .10"

Altro Atlas™ 40

King's Hall, US Naval Academy



Altro Atlas 40 is our most robust safety flooring, maintaining its integrity even when superficially punctured by studs or spikes. It's well suited to heavy-duty industrial use and sports changing rooms that see cleat traffic regularly.

Hard-wearing, stable and resistant to mechanical damage and chemicals, Altro Atlas 40 provides long-term durability and slip resistance, and is easy to clean and maintain.

Typical applications

Industrial areas exposed to heavy wheeled traffic, pallet trucks, forklifts, chemical processing, manufacturing, 24/7 commercial kitchens

Features + benefits

- Extremely durable
- Maintains surface integrity even when superficially punctured
- Well suited for commercial kitchen and industrial applications
- Resistant to mechanical damage and chemicals
- 4.0mm thickness provides ample underfoot comfort
- Easy to clean and maintain
- FloorScore Certified / Low VOCs



Looks great with

- Altro Puraguard
- Altro Stronghold 30
- Altro Classic 25
- Altro Reliance 25
- all Altro wall cladding options



Sustainability

- 10% post-consumer recycled content
- O-phthalate free
- Contains bio-based content
- FloorScore certified and low VOC compliant
- Contributes to LEED

[More content online www.altro.com](http://www.altro.com)



Samples

Experience has shown that printing cannot reproduce colors accurately. If color choice is critical, please request a sample of the material.

Samples are available on altro.com or through Material Bank.

1 in a million for life

.70D
.70W

.57 DCOF

Pendulum test
PTV ≥36

R₁₀

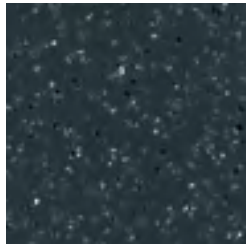

Anvil
X4094
WR101 / A1M72

LRV 11

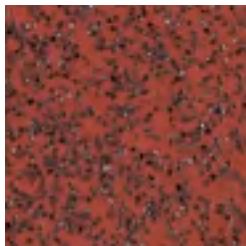

Quarry Red
X4060
WR42 / A1M42

LRV 13



Walnut
X4086
WR62 / A1M62

LRV 10

Featured in image above

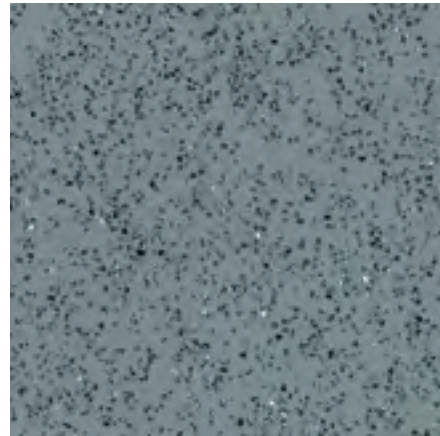

Pewter Grey
X4039
WR81 / A1M81

LRV 26



LRV = Light reflectance value

Please keep LRVs in mind when selecting flooring for areas with dementia and Alzheimer's patients, seniors or individuals with poor vision.



Color matched weldrods (WR) and mastics (A1M) are available. You'll find their product codes under product SKUs.



6'7" x 41' 2m x 12.5m
Format SHEET
Thickness 4mm .16"

Altro Aquarius™

1 in a
million
for life

.88D
1.03W

.65
DCOF

Pendulum test
PTV
≥50

R11



Bethany Riverview

Altro Aquarius was developed for lasting performance in wet and dry environments, shoes or barefoot. This 2mm safety floor has been extensively tested on a variety of shoe types (and bare feet) to ensure peak performance in a host of environments – bathrooms, changing areas, hydrotherapy pool surrounds. Anywhere you can expect a combination of wet and dry floors.

Altro Easyclean technology puts this range at the forefront of safety floor cleanability.

Typical applications

Bathrooms, showers, changing rooms, hydrotherapy pool surrounds, saunas

Features + benefits

- Optimum slip resistance in wet and dry environments, shoes or barefoot
- Achieves R11 slip resistance rating and SCoF of .88 dry, 1.03 wet
- Extensively tested on a variety of shoe types to ensure top performance
- Ideal for bathrooms, showers, changing areas and hydrotherapy pool surrounds
- Pairs with select Altro Walkway 20 colors for seamless coordination from wet rooms to general areas
- FloorScore Certified / Low VOCs



Looks great with

- Altro Whiterock
- Altro Wood
- Altro Walkway 20
- Altro Symphonia
- Altro Orchestra
- Altro Operetta
- all Altro wall cladding options



Sustainability

- 10% post-consumer recycled content
- O-phthalate free
- Contains bio-based content
- FloorScore certified and low VOC compliant
- Contributes to LEED

More content online www.altro.com



Samples

Experience has shown that printing cannot reproduce colors accurately. If color choice is critical, please request a sample of the material.

Samples are available on altro.com or through Material Bank.

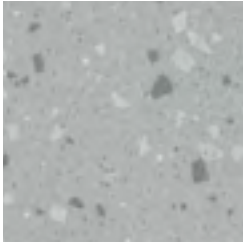

Puffin LRV 46
AQI2005
WR287 / A1M79

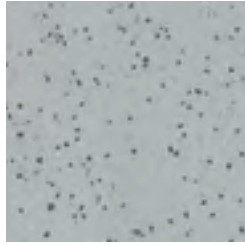

Cygnet LRV 46
AQ2004
WR287 / A1M79

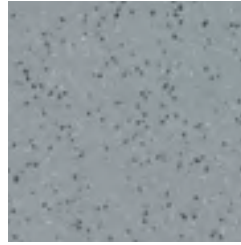

Walrus LRV 29
AQ2007
WR261 / A1M81

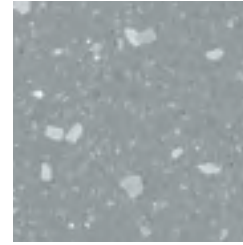

Tern LRV 31
AQI2008
WR261 / A1M81



Hippo LRV 11
AQI2013
WR301 / A1M82



Spoonbill LRV 11
AQI2016
WR303 / A1M303

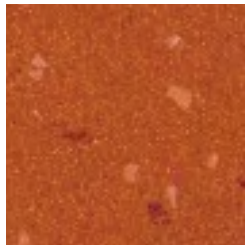

Coral Crab LRV 14
AQI2014
WR300 / A1M42



Mallard LRV 13
AQI2015
WR302 / A1M302

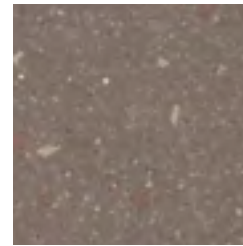

Otter LRV 26
AQI2006
WR290 / A1M239

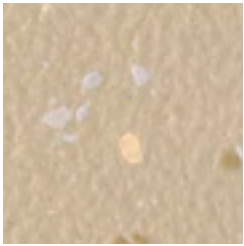

Curlew LRV 50
AQI2019
WR364 / A1M335

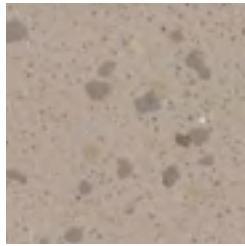

Terrapin LRV 40
AQI2009
WR289 / A1M265



Sealion LRV 37
AQI2018
WR363 / A1M265

Featured in image left

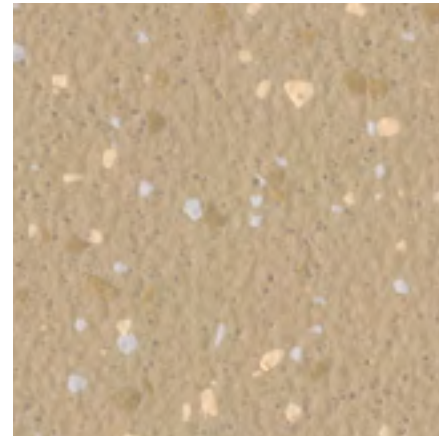

Sandpiper LRV 41
AQI2017
WR362 / A1M20

Additional colors of Altro Aquarius on next pages



LRV = Light reflectance value

Please keep LRVs in mind when selecting flooring for areas with dementia and Alzheimer's patients, seniors or individuals with poor vision.



Color matched weldrods (WR) and mastics (A1M) are available. You'll find their product codes under product SKUs.



CERTIFIED BY PCS Global Services

6'7" x 65'5"
2m x 20m
Format SHEET
Thickness 2mm .08"

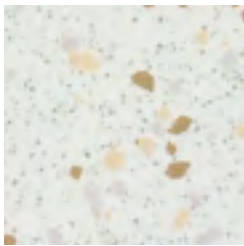

Swan LRV 75
AQI2012
WR291 / A1M01

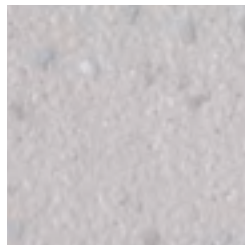

Gosling LRV 59
AQI2023
WR369 / A1M369

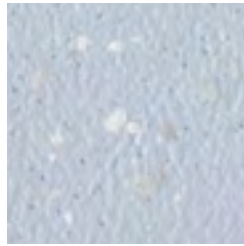

Sea Snail LRV 50
AQI2024
WR370 / A1M370

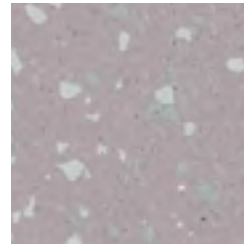

Salamander LRV 41
AQI2011
WR294 / A1M294

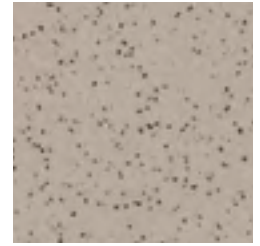

Vole LRV 43
AQ2010
WR289 / A1M265

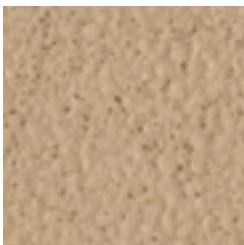

Iguana LRV 41
AQ2021
WR297 / A1M20



Jetty LRV 23
SB2017
WR418 / A1M239

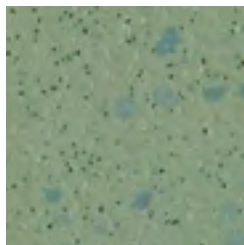

Treefrog LRV 33
AQI2003
WR293 / A1M271

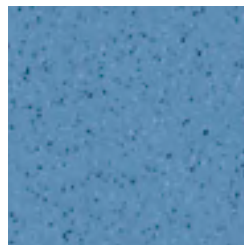

Dragonfly LRV 33
AQ2001
WR292 / A1M292

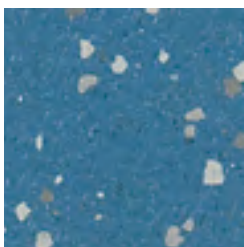

Blue Penguin LRV 24
AQI2002
WR288 / A1M71

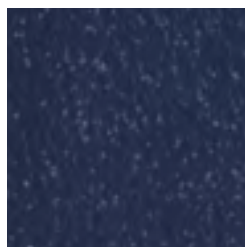

Newt LRV 10
AQ2022
WR368 / A1M368

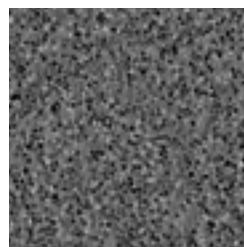

Anchor LRV 16
PX2008
WR391 / A1M82

i Shower Transition Trims

Available in four colors that were selected to complement and contrast most of the colors within the Altro Aquarius palette.

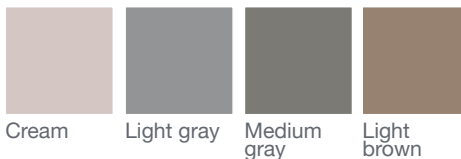

i Looks great with

- Altro Whiterock
- Altro Wood
- Altro Walkway 20
- Altro Symphonia
- Altro Orchestra
- Altro Operetta
- all Altro wall cladding options



Sustainability

- 10% post-consumer recycled content
- O-phthalate free
- Contains bio-based content
- FloorScore certified and low VOC compliant
- Contributes to LEED

More content online www.altro.com



Samples

Experience has shown that printing cannot reproduce colors accurately. If color choice is critical, please request a sample of the material.

Samples are available on altro.com or through Material Bank.



Lighthouse LRV 70
PX2001
WR291 / A1M01

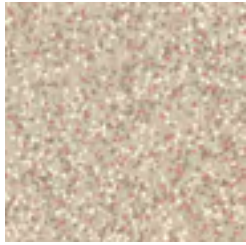

Cuttlefish LRV 50
PX2002
WR385 / A1M385

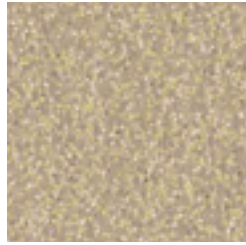

Breakwater LRV 42
PX2003
WR386 / A1M20

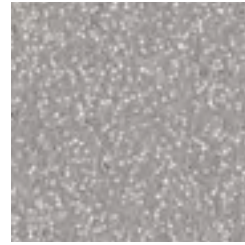

Shoreline LRV 38
PX2006
WR389 / A1M389

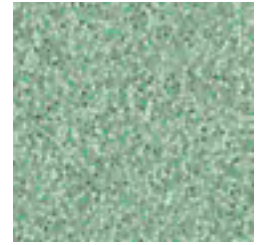

Windbreak LRV 38
PX2016
WR399 / A1M399



Fisherman LRV 48
PX2009
WR392 / A1M392

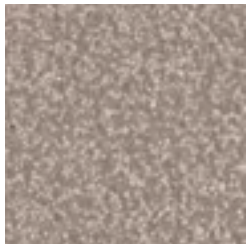

Driftwood LRV 32
PX2004
WR387 / A1M387

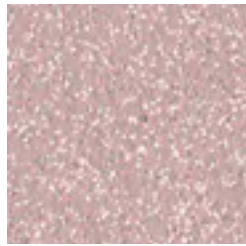

Seahorse LRV 47
PX2011
WR394 / A1M394

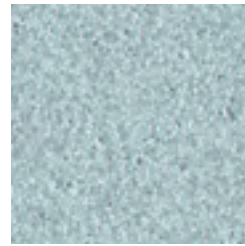

Deckchair LRV 50
PX2013
WR396 / A1M396

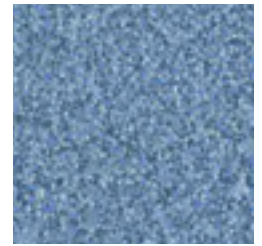

Houseboat LRV 25
PX2015
WR398 / A1M398

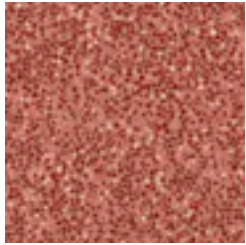

Starfish LRV 21
PX2010
WR393 / A1M393

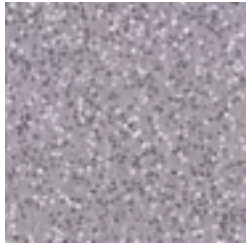

Beach hut LRV 37
PX2012
WR395 / A1M395

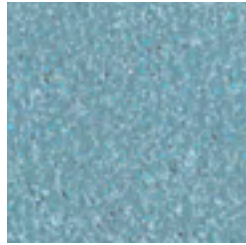

Sea Urchin LRV 34
PX2014
WR397 / A1M397

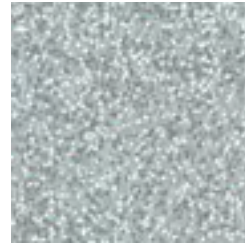

Jellyfish LRV 46
PX2005
WR388 / A1M388

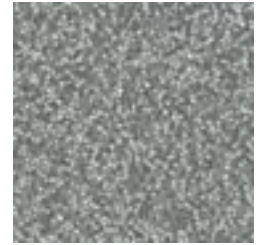

Porthole LRV 30
PX2007
WR390 / A1M390



LRV = Light reflectance value

Please keep LRVs in mind when selecting flooring for areas with dementia and Alzheimer's patients, seniors or individuals with poor vision.



Color matched weldrods (WR) and mastics (A1M) are available. You'll find their product codes under product SKUs.



6'7" x 65'5"
2m x 20m
Format SHEET
Thickness 2mm .08"



	Altro Stronghold 30	Altro Classic 25	Altro Atlas 40	Altro Aquarius
Format	sheet	sheet	sheet	sheet
Thickness	3mm .12"	2.5mm .10"	4mm .16"	2mm .08"
Width	2m 6'7"	2m 6'7"	2m 6'7"	2m 6'7"
Length	15m 49'	20m 65'5"	12.5m 41'	20m 65'5"
Weight	7.19 lbs /yd ²	5.89 lbs /yd ²	9.95 lbs /yd ²	4.79 lbs /yd ²
Warranty	12 years	12 years	15 years	10 years
Slip resistance				
ANSI/NFSI B101.3	.74 DCoF	.60 DCoF	.57 DCoF	.65 DCoF
ASTM D2047 dry / wet	.92/.88	.9/1.0	.70/.70	.88/1.03
DIN 51130	R12	R11	R10	R11
BS 7976 TRRL ASTM E303	55+	45+	36+	50+
Sound insulation				
ISO 10140	10dB	5dB	7dB	5dB
Test results				
Static load limit ASTM F970	2000psi	1000psi	500psi	1500psi
Surface burning CAN/ULC - S102.2	tested	tested	tested	tested
Critical radiant flux ASTM E648	Class 1	Class 1	Class 1	Class 1
Smoke generation ASTM E662	pass	pass	pass	pass
Cleaning technology				
Altro Easyclean	✓	✓	✓	✓
Sustainable attributes				
Recycled content % (pre /post)	0/10	0/10	0/10	0/10
O-phthalate-free	✓	✓	✓	✓
Low VOC	✓	✓	✓	✓
FloorScore certified	✓	✓	✓	✓
Bio-based content	✓	✓	✓	✓





slip- resistant flooring

In many commercial areas, your slip risk is not as high as specialized area types like commercial kitchens and other wet environments. But your patrons, patients, students and employees still deserve to be secure on their feet — and you deserve peace of mind. We offer slip-resistant flooring that meets and exceeds safety standards. It reduces the risk of slips and falls and looks good doing so. It has become a practical and durable commercial flooring solution in a variety of application areas.

Slip-resistant flooring

Why choose slip-resistant flooring?	32
Measuring durability, stain and chemical resistance	33
Slip-resistant product offerings	34
Technical chart	47

Why slip-resistant flooring?

Slip-resistant flooring is a practical solution to blending safety flooring properties with modern, less industrial, commercial flooring looks. It delivers peace of mind and looks good doing so. Slip-resistant offers customers durable flooring with enhanced stain protection and chemical resistance. It withstands heavy pedestrian traffic, heavy rolling loads and high PSI demands. Slip-resistant floors are a robust commercial flooring option for areas requiring heavy-duty flooring without an increased slip risk due to contaminants like oils, fats and soaps.

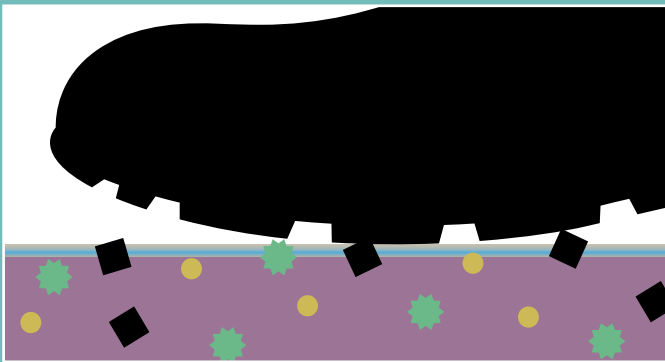

The pressure created by walking over slip-resistant flooring causes aggregates in the flooring to push up and rub against the shoe, creating friction. Because of this, Altro slip-resistant flooring remains safe, even when the surface profile is wet.

Typical slip-resistant applications

- Healthcare
- Education
- Back-of-house
- High-traffic areas
- Manufacturing and industrial areas
- Chemical processing
- Laboratories
- Veterinary
- Retail and public spaces
- Any location with moderate slip-risk or durability concerns

Measuring durability



Busy environments with various demands on the floors from foot traffic and rolling loads of heavy equipment require durable flooring. Our heavy-duty slip-resistant solutions are developed to meet your needs in these tough, working environments.

But how can durability be quantified? One way is through PSI testing. PSI testing (called static load limit testing) is a way of measuring flooring to see if it will indent under pressure.

While the industry standard only calls for tests up to 250 pounds per square inch, Altro tests beyond that. We understand that the demands of today's facilities call for products that can withstand greater amounts of weight.

For instance, a bariatric bed with a patient can weigh as much as 1,500 lbs and is only supported by four castor wheels. That is intense point loading and a competitor's floor with a 250lb/psi would fail. The floor would break or indent, leaving not only a safety and hygiene hazard, but an expensive repair and facility downtime as well.

Altro has products that are tested and proven to withstand weights of over 2,000 psi.

Chemical and stain resistance



Floors in heavy-duty application areas are often subjected to a barrage of aggressive chemicals. These surfaces see everything from decontaminants to germicidal cleaners and disinfectants on a regular basis. It is important your facility is furnished with materials that will stand up to these powerful agents.

Our slip-resistant flooring offers a high level of resistance against stains and resists many common chemicals such as sodium hypochlorite, phenolic disinfectants, and germicidal cleaners like Preempt and Simple Green D.

Regardless, it is still very important that steps are taken to ensure a long-lasting floor:

- Specify colors appropriate for the application area
- Use manufactured recommended cleaners
- Train maintenance staff on proper care and regular cleaning procedures
- Make critical staining areas in a darker color

Altro Reliance™ 25

The Deep Aquarium



Looking for a robust, heavy-duty solution for your back-of-house or front-of-house areas? With both traditional and modern looks in one slip-resistant range, it's easier than ever.

Confidence, trust and assurance – Altro Reliance 25 is a premium choice in heavy-duty commercial flooring. At 2.5mm thick, it is highly durable and can cope with high levels of foot and wheeled traffic without compromising on performance.

Combine Altro Reliance 25 with Altro wall protection for your toughest areas.

Typical applications

Healthcare, laboratories, kitchens, bars, cafeterias, veterinaries, industrial areas, manufacturing, machine shops, chemical processing, arenas and more



Looks great with

- Altro Walkway 20
- Altro Symphonia
- Altro Orchestra
- Altro Wood Comfort
- Altro Lavencia
- all Altro wall cladding options



Sustainability

- 10% post-consumer recycled content
- O-phthalate free
- Contains bio-based content
- FloorScore certified and low VOC compliant
- Contributes to LEED

[More content online www.altro.com](http://www.altro.com)



Samples

Experience has shown that printing cannot reproduce colors accurately. If color choice is critical, please request a sample of the material.

Samples are available on altro.com or through Material Bank.

Features + benefits

- Highly durable and robust at 2.5mm thick
- Both traditional and modern looks available
- Able to endure high levels of foot and wheeled traffic
- Withstands 2000psi
- Achieves high slip resistance levels
- Highly chemical and stain-resistant
- FloorScore Certified / Low VOCs

1 in a million for life | >.8D .9W | .56 DCOF | Pendulum test PTV ≥40 | R10



Featured in image above

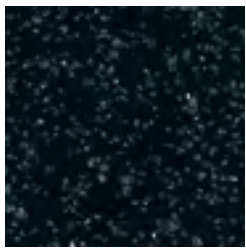

Jet
D2501
WR100 / A1M100

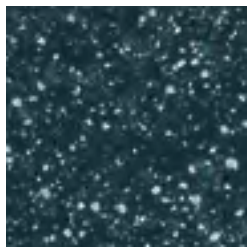

Midnight
D25421
WR72 / A1M72

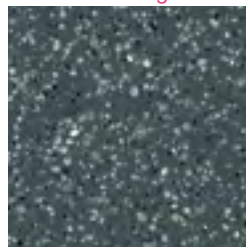

Storm
D25903
WR82 / A1M82

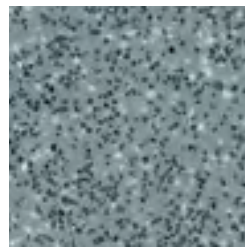

Fog
D25153
WR81 / A1M81

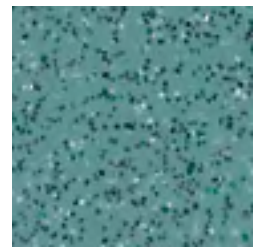

Skyline
D25332
WR52 / A1M52

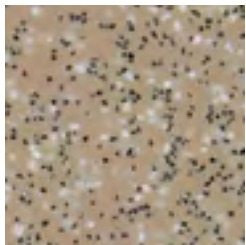

Biscuit
D25904
WR146 / A1M20

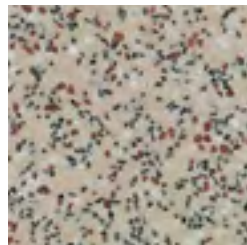

Bone
D25215
WR20 / A1M20

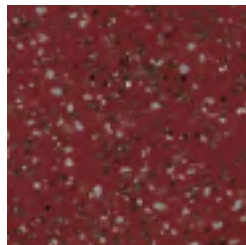

Rust
D25907
WR150 / A1M238



LRV = Light reflectance value

Please keep LRVs in mind when selecting flooring for areas with dementia and Alzheimer's patients, seniors or individuals with poor vision.



Color matched weldrods (WR) and mastics (A1M) are available. You'll find their product codes under product SKUs.

Additional, modern-look colors of Altro Reliance 25 on reverse



6'7" x 65'5"
2m x 20m
Format SHEET
Thickness 2.5mm .10"

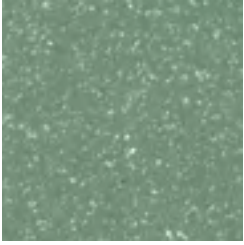

Roof Garden LRV 23
D2500
WR262 / A1M154

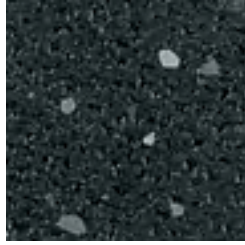

Vault LRV 5
D2517
WR277 / A1M100

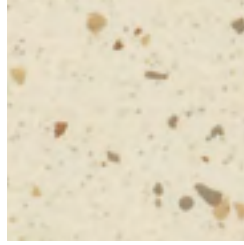

Ice Rink LRV 70
D2514
WR291 / A1M01

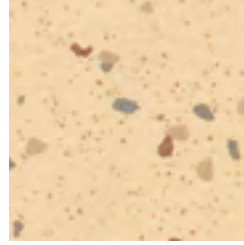

Statue LRV 62
D2513
WR304 / A1M12

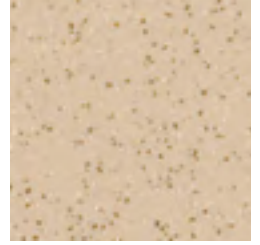

Arena LRV 41
D2510
WR297 / A1M20

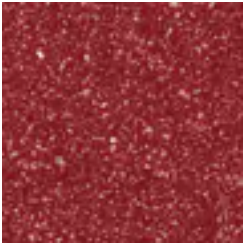

Forge LRV 9
D2515
WR248 / A1M238

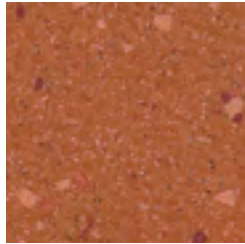

Signal LRV 13
D2516
WR300 / A1M42

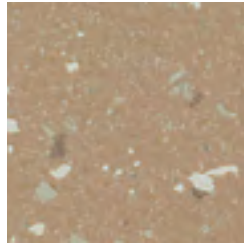

Plaza LRV 32
D2512
WR27 / A1M27

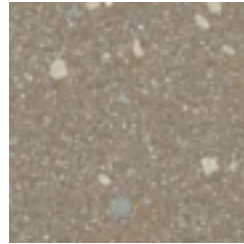

Monument LRV 23
D2508
WR305 / A1M239

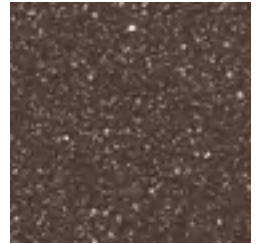

Gallery LRV 10
D2511
WR62 / A1M62



Pavement LRV 14
D2507
WR83 / A1M83

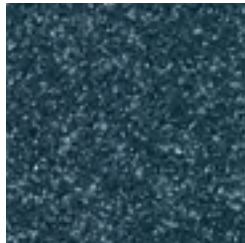

Runway LRV 9
D2506
WR72 / A1M72

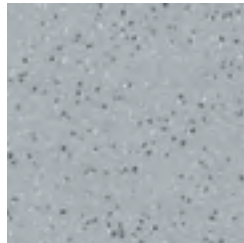

Temple LRV 27
D2509
WR261 / A1M81

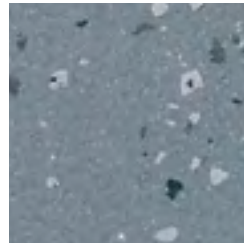

Rock LRV 23
D2504
WR84 / A1M84

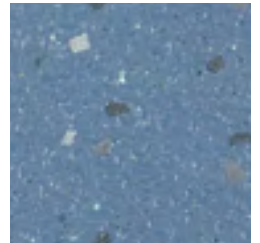

Fountain LRV 22
D2502
WR306 / A1M71

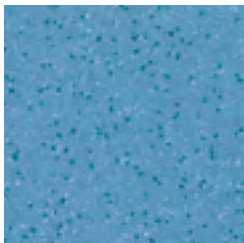

Stream LRV 22
D2518
WR288 / A1M71

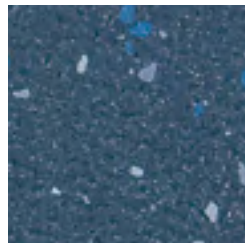

Pool LRV 10
D2503
WR307 / A1M73

Featured in image to the right

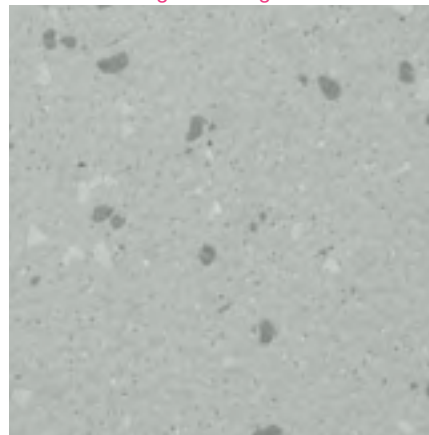

Streetlight LRV 45
D2505
WR287 / A1M79



Altro Walkway™ 20

1 in a
million
for Life.78D
.80W.66
DCOFPendulum test
PTV
≥36

R10

Gulf Coast Veterinary Clinic



Altro Walkway 20 is our hugely popular hard-wearing 2mm slip-resistant flooring. The range boasts many colors and shares its palette with Altro XpressLay. This enables you to combine both ranges when you need traditionally adhered and adhesive-free flooring in adjacent areas while maintaining a consistent look.

What's even better is Altro Walkway 20 offers you two distinct looks; traditional and modern. Both looks come with Altro EasyClean technology for superior cleanability and stain resistance.

A static-dissipative version is available, specifically designed for locations where static buildup must be avoided.

Typical applications

General purpose



Looks great with

- Altro XpressLay
- Altro Aquarius
- Altro Wood
- Altro Operetta
- Altro Symphonia
- all Altro wall cladding options



Sustainability

- 10% post and 10% pre-consumer recycled content
- O-phthalate free
- Contains bio-based content
- FloorScore certified and low VOC compliant
- Contributes to LEED

More content online www.altro.com



Samples

Experience has shown that printing cannot reproduce colors accurately. If color choice is critical, please request a sample of the material.

Samples are available on altro.com or through Material Bank.

Features + benefits

- Hard-wearing 2mm safety flooring
- Shares some colors with Altro XpressLay and Altro Aquarius for cross-product coordination
- Static-dissipative version available*
- Achieves high slip resistance ratings
- Exceeds 1000psi
- Excellent chemical and stain resistance
- FloorScore Certified / Low VOCs

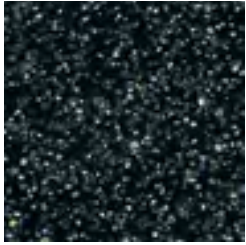

Black LRV 6
 VM20892
 WR100 / A1M100

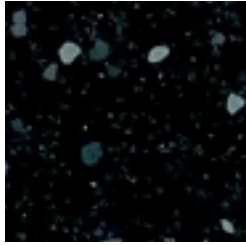

Coal LRV 6
 VMI2058
 WR100 / A1M100

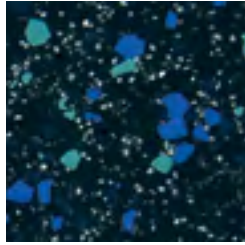

Nightfall LRV 10
 VMI2056
 WR72 / A1M72

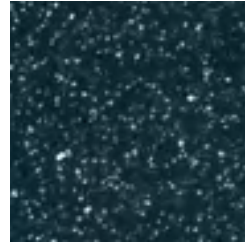

Midnight LRV 11
 VM20421
 WR72 / A1M72

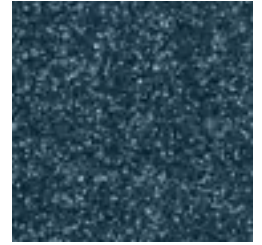

Runway LRV 9
 VM2006P
 WR72 / A1M72



Pavement LRV 14
 VMI2007P
 WR83 / A1M83

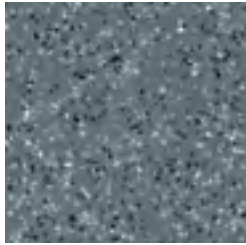

Dolphin LRV 21
 VM2010
 WR86 / A1M86

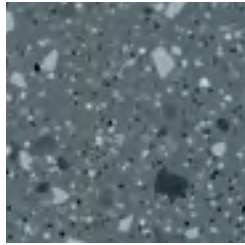

Whale LRV 20
 VMI2054
 WR86 / A1M86

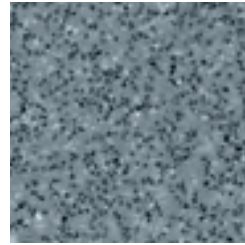

Fog* LRV 27
 VM20153
 WR81 / A1M81

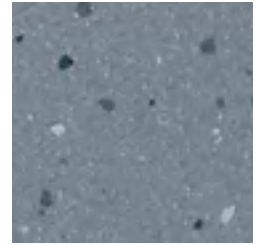

Rock LRV 23
 VMI2004P
 WR84 / A1M84

Also in static-dissipative

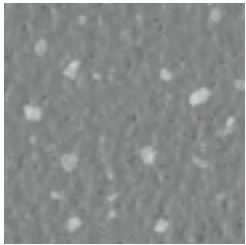

Nickel LRV 29
 VMI2019P
 WR81 / A1M81

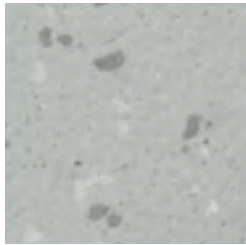

Streetlight LRV 45
 VMI2005P
 WR287 / A1M79

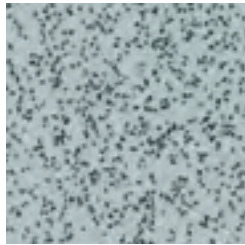

Cloud LRV 41
 VM2014
 WR79 / A1M191

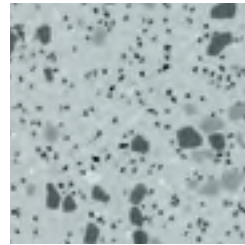

Blizzard LRV 44
 VMI2055
 WR79 / A1M191

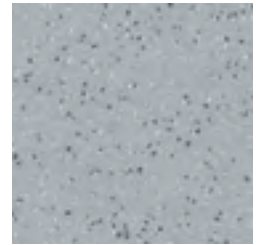

Temple LRV 27
 VM2009P
 WR261 / A1M81

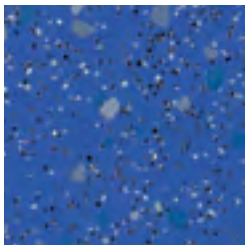

Lupin LRV 17
 VMI2059
 WR286 / A1M286

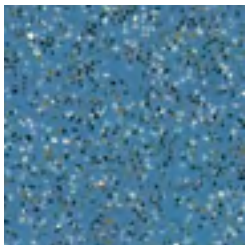

Blue LRV 22
 VM20412
 WR71 / A1M71

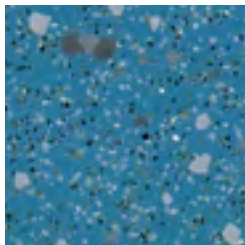

River LRV 22
 VMI2057
 WR71 / A1M71



LRV = Light reflectance value

Please keep LRVs in mind when selecting flooring for areas with dementia and Alzheimer's patients, seniors or individuals with poor vision.



Color matched weldrods (WR) and mastics (A1M) are available. You'll find their codes under product SKUs.



6'7" x 65'5"
2m x 20m
Format SHEET
Thickness 2mm .08"

Additional colors of Altro Walkway 20 on reverse



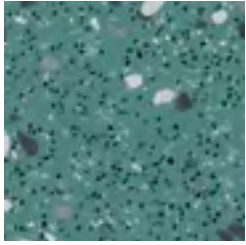

Tarragon LRV 26
 VMI2052
 WR52 / A1M52

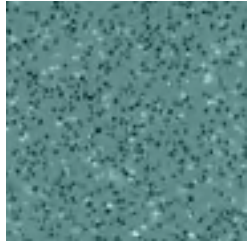

Skyline LRV 24
 VMI20332
 WR52 / A1M52

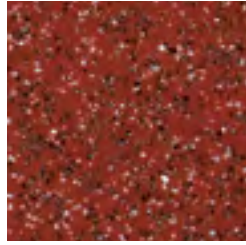

Tango LRV 14
 VMI2031
 WR42 / A1M42

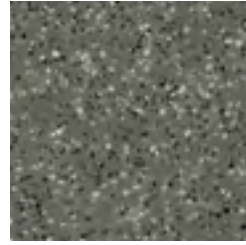

Tundra LRV 17
 VMI20910
 WR153 / A1M239

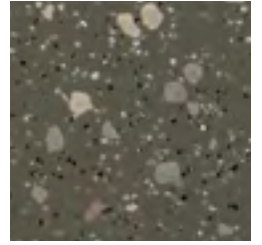

Savannah LRV 19
 VMI2050
 WR153 / A1M239

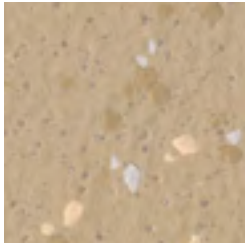

Tan LRV 41
 VMI2018P
 WR362 / A1M20

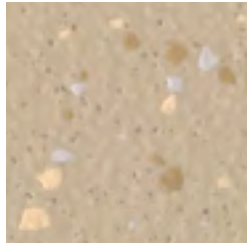

Bisque LRV 50
 VMI2021P
 WR364 / A1M335

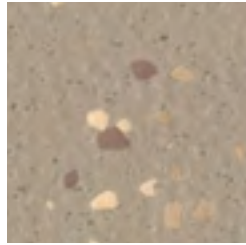

Rodeo LRV 37
 VMI2020P
 WR363 / A1M265

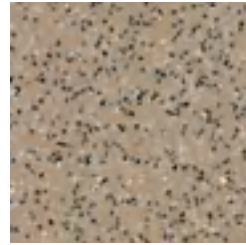

Biscuit LRV 30
 VMI20907
 WR146 / A1M20

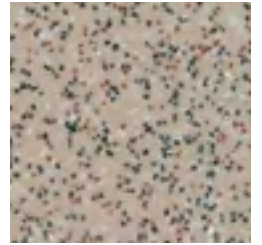

Bone LRV 37
 VMI20215
 WR20 / A1M20

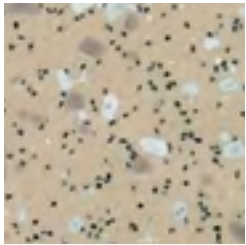

Sand LRV 40
 VMI2051
 WR20 / A1M20

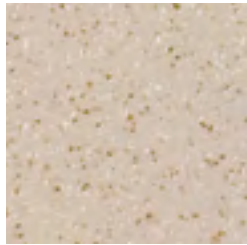

Minster LRV 40
 VMI2018P
 WR289 / A1M265

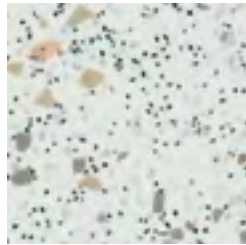

Winter LRV 61
 VMI2053
 WR105 / A1M01

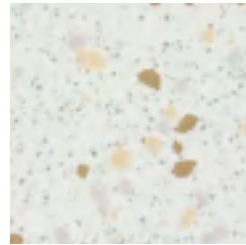

Swan LRV 75
 VMI2012P
 WR291 / A1M01

i **LRV = Light reflectance value**
 Please keep LRVs in mind when selecting flooring for areas with dementia and Alzheimer's patients, seniors or individuals with poor vision.

i Color matched weldrods (WR) and mastics (A1M) are available. You'll find their product codes under product SKUs.



6'7" x 65'5"
2m x 20m
Format SHEET
Thickness 2mm .08"

Altro Tungsten™

1 in a
million
for life

1.0D

Pendulum test
PTV
≥40

R₁₁

Goldsteig Cheese Factory



Extremely flexible and strong, Altro Tungsten is a PVC-free, fleece-backed acrylic sheet flooring range that fulfills the need for resilience and slip resistance in areas in which a traditional vinyl flooring is not the preferred option.

When faced with strict rulings regarding the use of PVC, you can trust Altro Tungsten to deliver the same quality you've come to expect from traditional slip-resistant sheet flooring.

Created with industry-leading Altro Easyclean, your PVC-free Altro Tungsten floor will stay looking new longer and will help save on maintenance costs over the life of the floor.

Typical applications

PVC-free applications



Looks great with

- Altro Reliance 25
- Altro Walkway 20
- Altro Operetta
- Altro Wood
- Altro Symphonia
- all Altro wall cladding options



Sustainability

- 4% post-consumer recycled content
- O-phthalate free
- Contains bio-based content
- Contributes to LEED

More content online www.altro.com



Samples

Experience has shown that printing cannot reproduce colors accurately. If color choice is critical, please request a sample of the material.

Samples are available on altro.com

Featured in image left

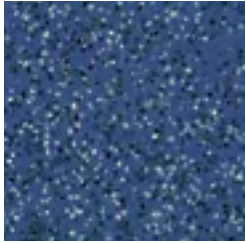

Azure
TUN203007
WR249 / A1M249

LRV 15

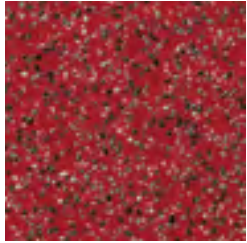

Sprite
TUN20911
WR248 / A1M238

LRV 11

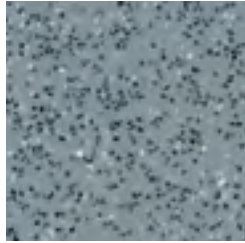

Fog
TUN203001
WR81 / A1M81

LRV 27

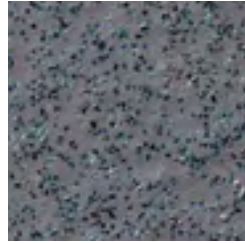

Breeze
TUN20909
WR86 / A1M86

LRV 18

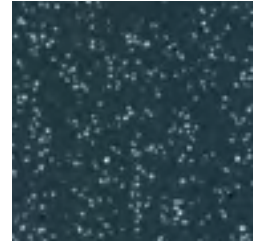

Midnight
TUN203005
WR72 / A1M72

LRV 11

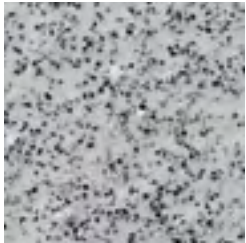

Whirlwind
TUN20910
WR79 / A1M191

LRV 38



Supercell
TUN20912
WR473 / A1M308

LRV 15

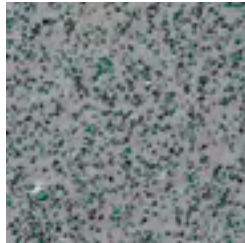

Gust
TUN20908
WR81 / A1M81

LRV 23

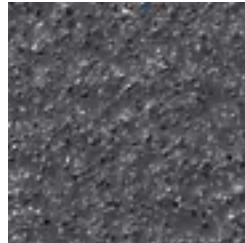

Arcus
TUN20906
WR101 / A1M72

LRV 11

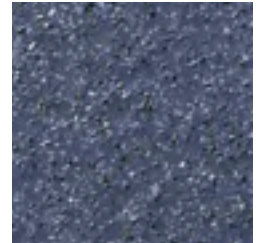

Sleet
TUN20907
WR231 / A1M73

LRV 10

What do the codes under swatches mean?

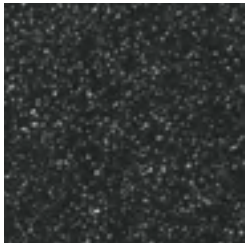

Vortex
TUN20905
WR277 / A1M100

LRV 6

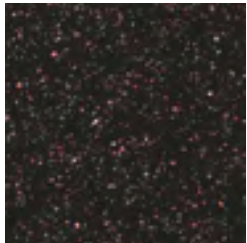

Firestorm
TUN20904
WR100 / A1M100

LRV 5

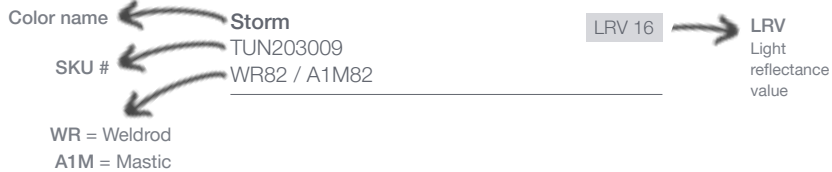
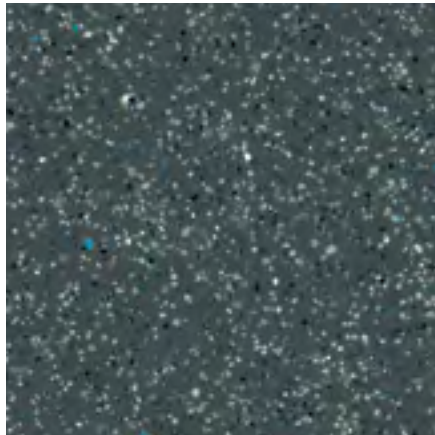

i **LRV = Light reflectance value**
Please keep LRVs in mind when selecting flooring for areas with dementia and Alzheimer's patients, seniors or individuals with poor vision.

i Color matched weldrods (WR) and mastics (A1M) are available. You'll find their product codes under product SKUs.



6'7" x 65'5"
2m x 20m
Format SHEET
Thickness 2mm .08"

Altro Promenade™

>.7D
>.8W

.38
DCOF

Pendulum test
PTV
≥45



Designed for exterior use, Altro Promenade sheet vinyl flooring provides essential slip resistance in areas exposed year-round to changing weather conditions. This range is ideal for indoor applications as well as patios, decks and pool surrounds that prioritize both safety and aesthetic appeal.

Altro Promenade's impervious surface prevents rainwater and excess moisture accumulation that can damage subfloors over time. It is capable of enduring harsh sunlight and fluctuating temperatures without cracking, fading, or falling apart, making it a practical solution for outdoor areas.

Altro Promenade offers a low-depth stepped embossing for smooth underfoot comfort and enhanced cleanability while still providing slip resistance.

Typical applications

Patios, decks, pool surrounds, spas, balconies, outdoor spaces



Looks great with

- Altro Reliance 25
- Altro Orchestra
- Altro Wood Comfort
- all Altro wall cladding options



Sustainability

- Low VOCs
- Contributes to LEED

[More content online www.altro.com](http://www.altro.com)



Samples

Experience has shown that printing cannot reproduce colors accurately. If color choice is critical, please request a sample of the material.

Samples are available on altro.com or through Material Bank.

Featured in image left



Antigua LRV 10
P404
WRP404 / A1M



Nevis LRV 16
P402
WRP402 / A1M239

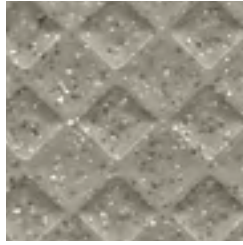

Kitts LRV 28
P401
WRP401 / A1M265



Turks LRV 17
P643
WRP643 / A1M239



Barbuda LRV 15
P640
WRP640 / A1M239



Grenada LRV 22
P642
WRP642 / A1M200



Trinidad LRV 51
P807
WRP807 / A1M200

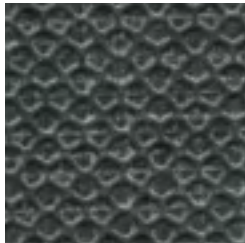

Tobago LRV 7
P603
WRP603 / A1M100



Martinique LRV 43
P801
WRP801 / A1M272

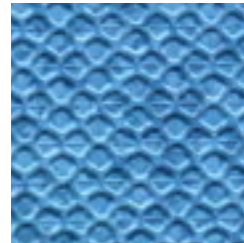

Curacao LRV 25
P802
WRP802 / A1M71



LRV = Light reflectance value

Please keep LRVs in mind when selecting flooring for areas with dementia and Alzheimer's patients, seniors or individuals with poor vision.



Color matched weldrods (WRP) and mastics (A1M) are available. You'll find their product codes under product SKUs.



5'11" x 32'9" 1.82m x 10m
Format SHEET
Thickness 2.5mm .10"



Lutterworth High School - Altro Walkway 20 with waterjet emblem

	Altro Reliance 25	Altro Walkway 20	Altro Tungsten	Altro Promenade
Format	sheet	sheet	sheet	sheet
Thickness	2.5mm .10"	2mm .08"	2mm .08"	2.5mm .10"
Width	2m 6'7"	2m 6'7"	2m 6'7"	1.82m 5'11"
Length	20m 65' 5"	20m 65' 5"	20m 65' 5"	10m 32'9"
Weight	6.27 lbs /yd ²	4.79 lbs /yd ²	4.98 lbs /yd ²	120 lbs (roll weight)
Warranty	15 years	10 years	10 years	10 years
Slip resistance				
ANSI/NFSI B101.3	.56 DCoF	.66 DCoF		.38 DCoF
ASTM D2047 dry / wet	≥.8 / .9	.78/.80	1.0 dry	.7/.8
DIN 51130	R10	R10	R11	
BS 7976 TRRL ASTM E303	40+	36+	40+	45+
Sound insulation				
ISO 10140	7dB	5dB	1dB	
Test results				
Static load limit ASTM F970	2000psi	1000psi		1000psi
Surface burning CAN/ULC - S102.2	tested	tested	tested	tested
Critical radiant flux ASTM E648	Class 1	Class 1	Class 1	Class 1
Smoke generation ASTM E662	pass	pass	pass	pass
Cleaning technology				
Altro Easyclean	✓	✓	✓	
Sustainable attributes				
Recycled content % (pre /post)	0/10	10/10	0/4	0/0
O-phthalate-free	✓	✓	✓	
Low VOC	✓	✓		✓
FloorScore certified	✓	✓		
Bio-based content	✓	✓	✓	





adhesive-free flooring

Our award-winning adhesive-free flooring has expanded to include three unique ranges with differing aesthetics and physical attributes. Each of these solutions offer unique advantages that make them adaptable to your design's specific needs.

Adhesive-free flooring

Why adhesive-free flooring?	50
Benefits of Altro adhesive-free	51
Adhesive-free sheet product offerings	52
Technical chart	63



Why adhesive-free sheet flooring?

Altro's award-winning, adhesive-free floors now feature new ranges offering you enhanced comfort underfoot and greater impact sound reduction. With more color and wood-look options, these solutions provide complete flexibility for different application areas and aesthetic appeal.

Teamed with the benefits of reduced installation time, cost savings and sustainable attributes, we invite you to discover how Altro adhesive-free is the next step in the evolution of commercial flooring.

- Smooth and slip-resistant options
- Classic, modern and wood-look visuals
- Underfoot comfort and sound reduction - 14dB (Altro Cantata and Altro Wood adhesive-free)
- Quickly installs with tape for minimal downtime
- Can be welded and walked on same day
- Install in areas up to 98% relative humidity
- Embossed backing allows subfloor moisture to dissipate
- No adhesive odors
- Easy removal allows it be uplifted, reused and recycled
- Contains rapidly renewable bio-based content
- Emits low VOCs
- Many match and/or coordinate with glue-down counterparts

Typical adhesive-free applications

- General purpose use throughout all sectors
- Fast track projects
- Temporary and modular building
- Healthcare
- Education
- Historical buildings





Less downtime

With Altro adhesive-free sheet flooring, surface damp-proof membranes and adhesives are a thing of the past. Your installation can be up and ready in half the time of a traditional adhered sheet floor, letting you get back to business with minimal interruption to your schedule.

Install over existing flooring

Altro adhesive-free flooring can be installed over existing intact substrates without applying adhesive. This can save you thousands in expensive flooring removal and asbestos abatement.



Heavy rolling loads

Altro adhesive-free sheet flooring holds effectively. In fact, it has been tested with a 1,975lbs (900kg) drilling rig with caterpillar tracks. A patient on a hospital bed, utility carts, or heavy equipment is no problem at all!

Adhesive-free sheet flooring holds as effectively as Altro glue-down sheet flooring; no rucks, no movement. They achieve optimum installation results and conformity to our 10-year warranty!

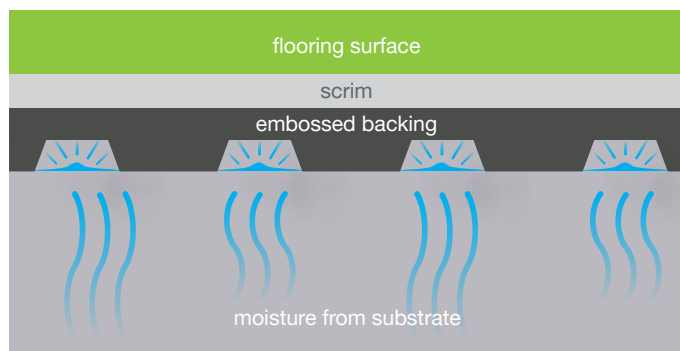

Moisture problem? Not anymore!

The specially formulated studded underside emboss allows Altro adhesive-free sheet flooring to sit off the subfloor, letting the floor breathe, resulting in any moisture dissipating.

Fresh slab? No problem!

The revolutionary underside emboss means that Altro adhesive-free sheet flooring can be used on fresh concrete subfloors up to 98% relative humidity (RH).

There is no need to wait for new concrete to reach 90% RH, allowing you to install flooring quickly and easily without having to wait for the substrate to dry.



Remove, reuse, recycle

Altro adhesive-free sheet flooring is 100% recyclable post-consumer and can be reused in other installations.

We have numerous success stories of re-purposing large format installations in which the floor is installed temporarily, lifted and used again.

At its end of life, Altro adhesive-free sheet flooring can be removed quickly and reused or recycled; there's no flooring covered with adhesive and bits of substrate to deal with.

Altro XpressLay™



Reading University



The world's first adhesive-free safety floor that can save you money on materials and time on installation. Altro XpressLay is the next step in the evolution of safety flooring. It's installed using a tape system instead of adhesive - so it can be installed without a surface DPM. This means that you can weld the same day it is installed, greatly reducing installation time. It can be easily removed post-installation, reused elsewhere and then recycled at the end of its life.

Altro XpressLay includes a wide range of colors featuring bright and subtle, sparkle-free designs and decorative chipped options. We know how important it is that your floor stays looking good year after year, so we've added Altro Easyclean for superior chemical and stain resistance.

Typical applications

General purpose, fast-track, retrofits, education, temporary healthcare, modular and historical buildings



Looks great with

- Altro Walkway 20
- Altro Cantata
- Altro Wood adhesive-free
- Altro Lavencia
- all Altro wall cladding options



Sustainability

- 5% post-consumer recycled content
- O-phthalate free
- Contains bio-based content
- FloorScore certified and low VOC compliant
- Contributes to LEED

[More content online www.altro.com](http://www.altro.com)



Samples

Experience has shown that printing cannot reproduce colors accurately. If color choice is critical, please request a sample of the material.

Samples are available on altro.com or through Material Bank.

Features + benefits

- One-in-a-million slip resistance reassurance
- Quickly installs with tape
- Can be welded and walked on same day
- Install in areas up to 98% relative humidity
- Embossed backing allows moisture to dissipate
- No adhesive odors
- Easy removal - uplift, reuse and recycle
- Contains rapidly renewable bio-based content
- Emits low VOCs
- Coordinates with popular Altro Walkway 20

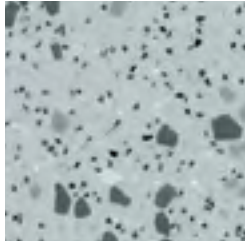

Blizzard LRV 44
 XLI2255
 WR79 / A1M191

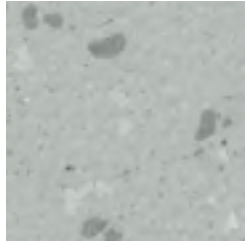

Streetlight LRV 45
 XLI2205P
 WR287 / A1M79

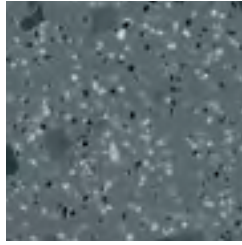

Whale LRV 20
 XLI2254
 WR86 / A1M86

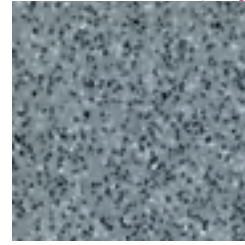

Fog LRV 27
 XLI22153
 WR81 / A1M81

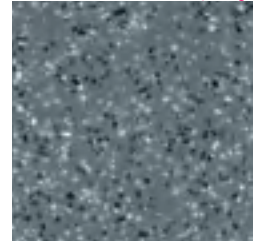

Dolphin LRV 21
 XL2210
 WR86 / A1M86



Pavement LRV 14
 XLI2207P
 WR83 / A1M83

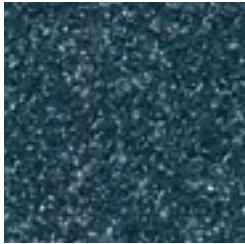

Runway LRV 9
 XL2206P
 WR72 / A1M72

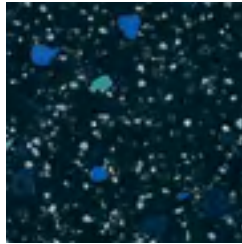

Nightfall LRV 10
 XLI2256
 WR72 / A1M72

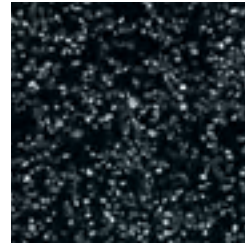

Black LRV 6
 XL22892
 WR100 / A1M100

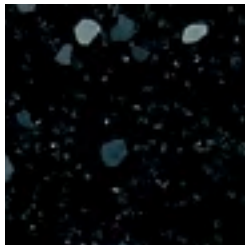

Coal LRV 6
 XLI2258
 WR100 / A1M100

Featured in image left

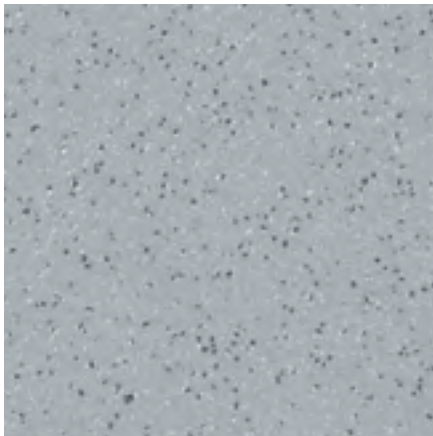

Temple LRV 27
 XL2209P
 WR261 / A1M81

Pink indicates quick ship colors | Additional colors of Altro XpressLay on reverse

i **LRV = Light reflectance value**
 Please keep LRVs in mind when selecting flooring for areas with dementia and Alzheimer's patients, seniors or individuals with poor vision.

i Color matched weldrods (WR) and mastics (A1M) are available. You'll find their product codes under product SKUs.



6'7" x 65'5"
2m x 20m
Format SHEET
Thickness 2.2mm 0.87"

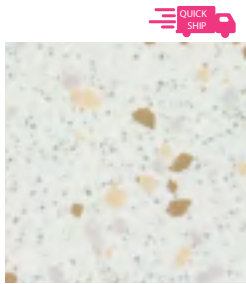

Swan
 XLI2212P
 WR291 / A1M01

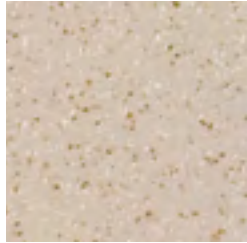

Minster
 XL2218P
 WR289 / A1M265

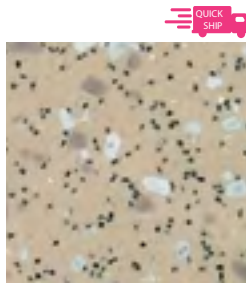

Sand
 XLI2251
 WR20 / A1M20

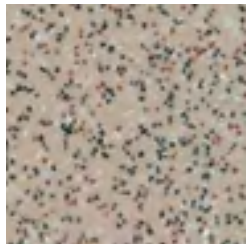

Bone
 XL22215
 WR20 / A1M20

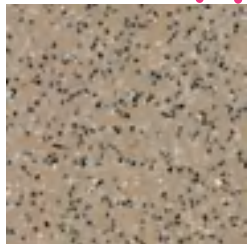

Biscuit
 XL22907
 WR146 / A1M20

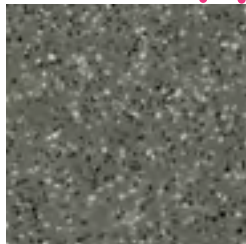

Tundra
 XL22910
 WR153 / A1M239

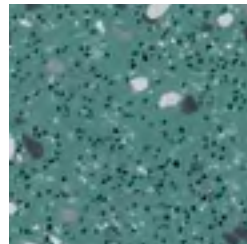

Tarragon
 XLI2252
 WR52 / A1M52

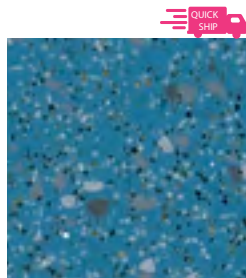

River
 XLI2257
 WR71 / A1M71

What do the codes under swatches mean?

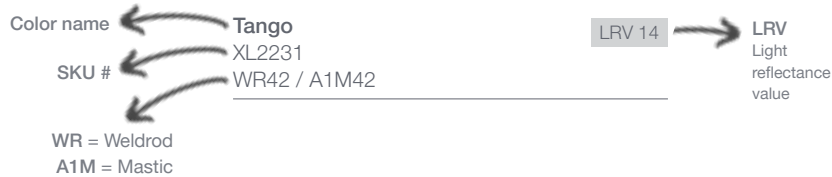
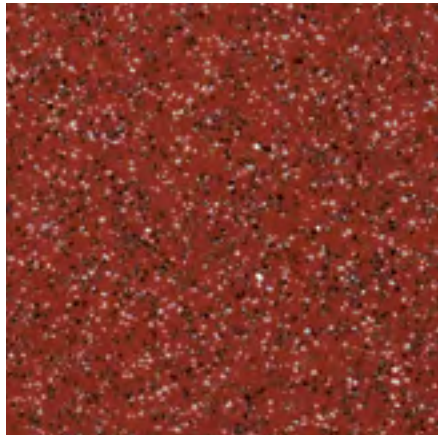

- i Looks great with**
- Altro Walkway 20
 - Altro Cantata
 - Altro Wood adhesive-free
 - Altro Lavencia
 - all Altro wall cladding options

- 🌍 Sustainability**
- 5% post-consumer recycled content
 - O-phthalate free
 - Contains bio-based content
 - FloorScore certified and low VOC compliant
 - Contributes to LEED
- [More content online www.altro.com](http://www.altro.com)

- 📄 Samples**
- Experience has shown that printing cannot reproduce colors accurately. If color choice is critical, please request a sample of the material.
- Samples are available on altro.com or through Material Bank.

FOOD FOR THOUGHT CONDIMENTS LUNCH FROM THE EAT
CUISINE AL FRESCO DIET FRUIT



Altro Wood™ adhesive-free



New Altro Wood adhesive-free creates maximum impact with minimum downtime. With a wide variety of color choices, 14dB sound reduction, a 10-year warranty and our Altro one-in-a-million slip resistance reassurance, Altro Wood adhesive-free offers high levels of comfort underfoot providing a safe, durable and decorative solution for busy spaces.

Using our award-winning adhesive-free installation method, it can be welded and walked on the same day, and at the end of its life can be removed easily, allowing it to be reused or recycled. Using Altro adhesive-free floors, you can halve installation time compared with a traditional adhered installation. It is ideal for busy public spaces where disruption needs to be minimal, plus there are no associated adhesive odors.

Typical applications

Healthcare, temporary healthcare, modular buildings, historical buildings, senior living, education, retail and offices, hallways, general circulation areas



Looks great with

- Altro Cantata
- Altro Wood Comfort
- Altro XpressLay
- all Altro wall cladding options



Sustainability

- O-phthalate free
- Contains bio-based content
- FloorScore certified and low VOC compliant
- Contributes to LEED

More content online www.altro.com



Samples

Experience has shown that printing cannot reproduce colors accurately. If color choice is critical, please request a sample of the material.

Samples are available on altro.com or through Material Bank.

Features + benefits

- One-in-a-million slip resistance reassurance
- Underfoot comfort
- Sound reduction - 14dB
- Quickly installs with tape - weld and walk
- Install in areas up to 98% relative humidity
- Embossed backing allows moisture to dissipate
- No adhesive odors
- Easy removal - uplift, reuse and recycle
- Authentic looking wood-grain visuals
- Has matching looks in 2mm, 2.85mm and 3.9mm



AF Bleach. Oak LRV 52
AFW280001
WR335 / A1M335



AF Wash. Oak LRV 38
AFW280007
WR347 / A1M347

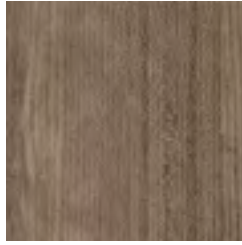

AF Urb. Cherry LRV 17
AFW280004
WR337 / A1M337

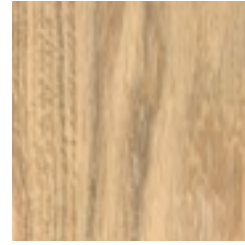

AF Farm. Oak 38
AFW280010
WR338 / A1M338

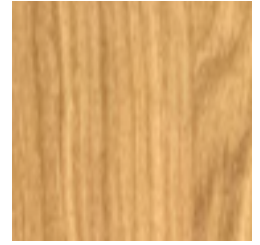

AF Rustic Oak LRV 37
AFW280005
WR340 / A1M340

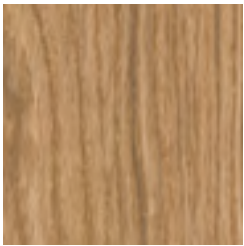

AF Oak Trad. LRV 25
AFW280006
WR353 / A1M225

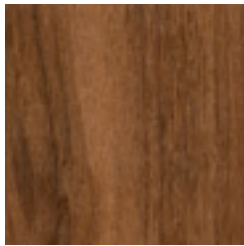

AF Ant. Walnut LRV 15
AFW280009
WR341 / A1M160



AF Worn Oak LRV 19
AFW280012
WR322 / A1M239



AF Manor Oak LRV 7
AFW280008
WR348 / A1M348



AF Aut. Maple LRV 24
AFW280002
WR339 / A1M339



AF Spg. Maple LRV 27
AFW280011
WR352 / A1M352

Featured in image left



AF Vintage Cherry LRV 22
AFW280003
WR336 / A1M239



LRV = Light reflectance value

Please keep LRVs in mind when selecting flooring for areas with dementia and Alzheimer's patients, seniors or individuals with poor vision.



Color matched weldrods (WR) and mastics (A1M) are available. You'll find their product codes under product SKUs.



6'7" x 65'5"
2m x 20m
Format SHEET
Thickness 2.4mm .09"



Altro Cantata™



New Altro Cantata is a tonal and modernist, adhesive-free floor. It is ideal for busy public spaces where disruption needs to be minimal, and has no associated adhesive odors. Using our award-winning adhesive-free installation method, it can be welded and walked on the same day, and at the end of its life can be removed easily, allowing it to be reused or recycled.

Altro Cantata also looks great paired with other adhesive-free ranges or may be used alongside a traditional glue-down flooring.

Typical applications

Healthcare, temporary healthcare, modular buildings, historical buildings, senior living, education, retail and offices, hallways, general circulation areas

Features + benefits

- Underfoot comfort
- Sound reduction - 14dB
- Quickly installs with tape - weld and walk
- Install in areas up to 98% relative humidity
- Embossed backing allows moisture to dissipate
- No adhesive odors
- Easy removal - uplift, reuse and recycle
- Contains rapidly renewable bio-based content
- Emits low VOCs



Looks great with

- Altro Wood adhesive-free
- Altro XpressLay
- Altro Wood Comfort
- Altro Orchestra
- all Altro wall cladding options



Sustainability

- O-phthalate free
- Contains bio-based content
- FloorScore certified and low VOC compliant
- Contributes to LEED

More content online www.altro.com



Samples

Experience has shown that printing cannot reproduce colors accurately. If color choice is critical, please request a sample of the material.

Samples are available on altro.com or through Material Bank.



Crème Caramel LRV 50
AFP282006
WR385 / A1M385

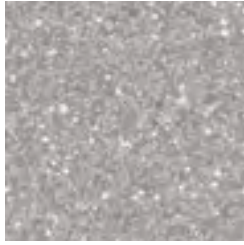

Mocha LRV 40
AFP282003
WR389 / A1M389

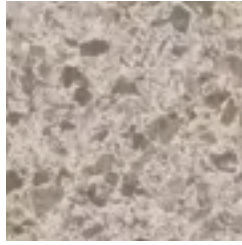

Treviso LRV 44
AFT284003
WR483 / A1M483

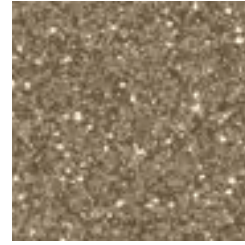

Hazelnut LRV 18
AFP282009
WR418 / A1M239

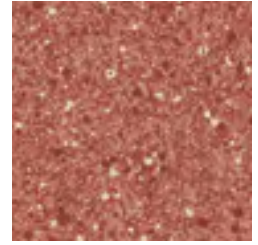

Sunrise LRV 19
AFP282008
WR393 / A1M393



Bluefin LRV 26
AFC281001
WR438 / A1M486

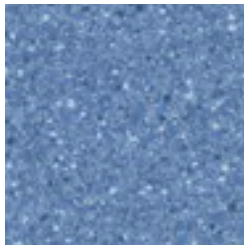

Bluebell LRV 26
AFP282004
WR398 / A1M398

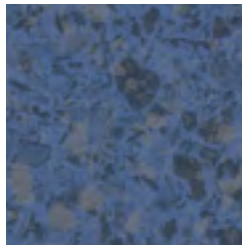

Milan LRV 15
AFT284002
WR482 / A1M482

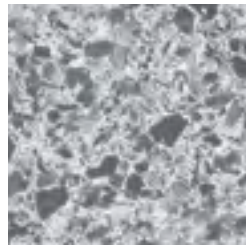

Venice LRV 40
AFT284004
WR484 / A1M484

Featured in image left

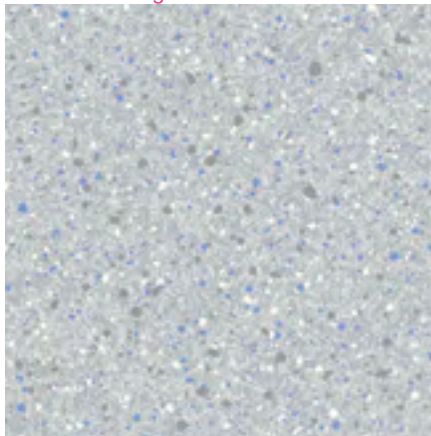

Frosted Glass LRV 52
AFP282005
WR388 / A1M388

Additional colors of Altro Cantata on reverse



LRV = Light reflectance value

Please keep LRVs in mind when selecting flooring for areas with dementia and Alzheimer's patients, seniors or individuals with poor vision.



Color matched weldrods (WR) and mastics (A1M) are available. You'll find their product codes under product SKUs.



6'7" x 65'5"
2m x 20m
Format SHEET
Thickness 2.4mm .09"



Seal Gray LRV 26
AFC281002
WR435 / A1M390

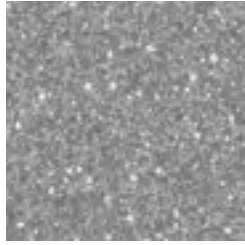

Graphite LRV 30
AFP282002
WR390 / A1M390

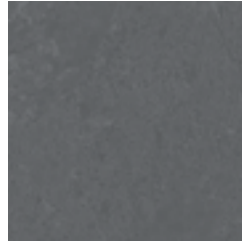

Elephant Gray LRV 17
AFC281003
WR436 / A1M487

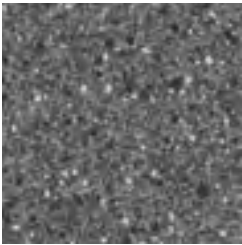

True Grit LRV 17
AFP282001
WR391 / A1M82

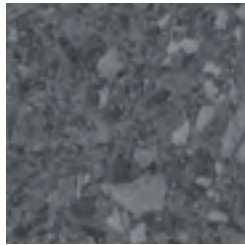

Rome LRV 16
AFT284001
WR481 / A1M83

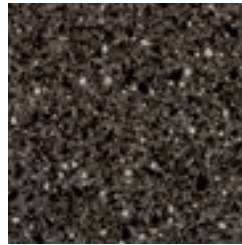

Black Sand LRV 7
AFP282010
WR485 / A1M485

Featured in image right

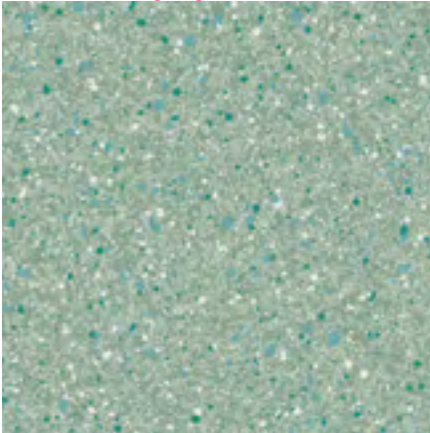

Willow Tree LRV 41
AFP282007
WR399 / A1M399



Looks great with

- Altro Wood adhesive-free
- Altro Wood Comfort
- Altro Orchestra
- Altro XpressLay
- all Altro wall cladding options



Barenwise Veterinary Clinic - Altro Cantata





Altro Wood adhesive-free shown in Farmhouse Oak and Bleached Oak with Altro Whiterock PopArt

	Altro XpressLay	Altro Wood A.F.	Altro Cantata
Format	sheet	sheet	sheet
Thickness	2.2mm .087"	2.4mm .09"	2.4mm .09"
Width	2m 6'7"	2m 6'7"	2m 6'7"
Length	20m 65' 5"	20m 65' 5"	20m 65' 5"
Weight	4.79lbs /yd ²	4.42 lbs /yd ²	4.42 lbs /yd ²
Warranty	10 years	10 years	10 years
Slip resistance			
Dynamic Coefficient of Friction	.66 DCoF	.78 DCoF	.70 DCoF
ASTM D2047 dry / wet	.78/.80 SCoF	.79/.94 SCoF	.79/.94 SCoF
DIN 51130	R10	R10	R10
BS 7976 TRRL ASTM E303	36+	36+	36+
Sound insulation			
ISO 10140	7dB	14dB	14dB
Test results			
Static load limit ASTM F970	2000psi	1000psi	1000 psi
Surface burning CAN/ULC - S102.2	tested	tested	tested
Critical radiant flux ASTM E648	Class 1	Class 1	Class 1
Smoke generation ASTM E662	pass	pass	pass
Cleaning technology			
Altro Easyclean	✓	✓	✓
Sustainable attributes			
Recycled content % (pre /post)	0/5	0/0	0/0
O-phthalate-free	✓	✓	✓
Low VOC	✓	✓	✓
FloorScore certified	✓	✓	✓
Bio-based content	✓	✓	✓



Altro Cantata in Seal Gray shown

smooth flooring

Altro smooth flooring provides attractive designs that are easy to maintain and install. Whether it's looks, durability or life cycle costs that concern you most, smooth flooring delivers on every count. Our smooth flooring ranges are suitable for a wide array of application areas.

Smooth flooring

Why smooth flooring?	66
Smooth sheet product offerings	68
Smooth tile and LVT product offerings	90
Technical chart	106

Why smooth flooring?

Smooth flooring from Altro gives you what you want - an economical and attractive look that's easy to install and maintain. Better yet, our smooth flooring has had a significant makeover. This collection of practical design options blends an expansive color palette with integrated acoustic and hygiene benefits as well as ample comfort underfoot.

From realistic wood and linen visuals to stylish, low-maintenance LVT and even durable rubber tiles, our smooth flooring can easily adapt to fit the unique needs of your design.



What type of smooth flooring do you need?

- Smooth slip resistance - Altro Symphonia
- Underfoot comfort and noise reduction - Altro Serenade, Altro Wood Acoustic, Altro Orchestra, Altro Wood Comfort
- Budget friendly, contract sheet - Altro Wood, Altro Operetta
- Adhesive-free - Please see previous chapter on adhesive-free flooring
- Luxury vinyl tile/plank - Altro Lavencia LVT
- Robust, durable tiles - Altro Quartz Tile, Altro Ollero
- Homogeneous tile - Altro Dolce

Typical smooth applications

- Healthcare
- Senior living
- Retail
- Offices
- Education
- Hospitality
- Housing



Better together

In commercial areas of frequent spills, hygiene and durability concerns, it's best to let our robust collection of safety and slip-resistant flooring join the team.

Install smooth flooring in the dining room and public areas, and bring safety (or slip-resistant) flooring and wall protection into the kitchen, bar, service areas and restrooms.

You will rest easy knowing your patrons will have an exquisite experience while the most dangerous areas in your facility are well equipped to handle the tolls of the day.

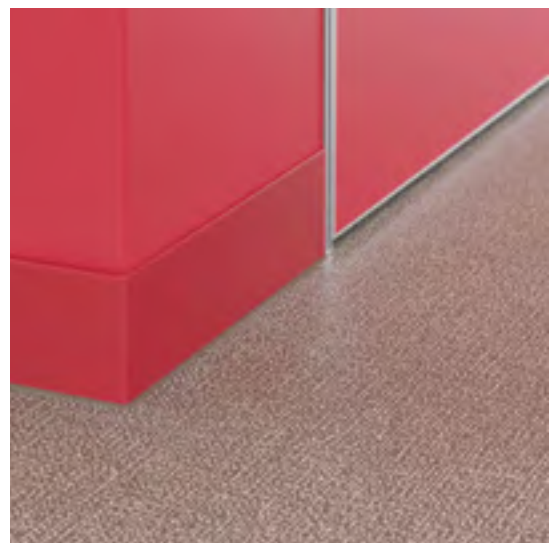

Altro Symphonia™



First Hill Surgery

Bold, bright and beautiful - Altro Symphonia was engineered to deliver striking looks and bridge the gap between smooth and slip-resistant flooring.

Altro Symphonia is smooth to the touch and easy to clean, yet will secretly enhance pedestrian safety. With four unique looks and 41 shades from pale neutrals to bright yellows, greens and blues, you can easily vary your interior's mood and sophistication. But don't let Altro Symphonia's delightfully smooth surface fool you. It delivers all the durability you would expect from Altro, including a 10-year warranty.

Typical applications

Hospitals, operating rooms, patient rooms, lobbies, senior living communities, education, retail, cafés, general front-of-house and multi-purpose areas



Looks great with

- Altro Wood
- Altro Operetta
- Altro Walkway 20
- all Altro wall cladding options



Sustainability

- 5% post-consumer recycled content
- O-phthalate free
- Contains bio-based content
- FloorScore certified and low VOC compliant
- Contributes to LEED

More content online www.altro.com



Samples

Experience has shown that printing cannot reproduce colors accurately. If color choice is critical, please request a sample of the material.

Samples are available on altro.com or through Material Bank.

Features + benefits

- Bridges the gap between smooth and slip-resistant flooring
- Impressive chemical and stain resistance, ideal for healthcare applications
- Achieves R10 slip resistance rating and SCoF of .8 dry, .9 wet
- Meets ISO Class 4 cleanroom requirements
- Resists up to 2,000 psi indentation
- FloorScore Certified / Low VOCs



Iceberg
PH2003
WR284 / A1M01

Featured in image left

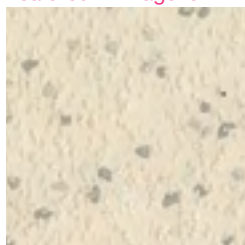

Crystal
PH2007
WR284 / A1M01

Featured in image left

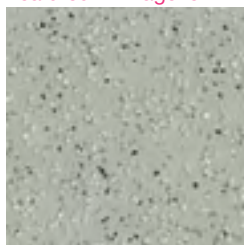

Vapor
PH2004
WR191 / A1M191



Squall
PH2011
WR372 / A1M81

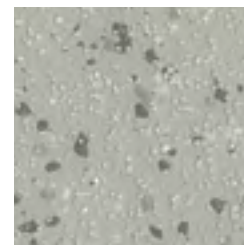

Frozen
PH2008
WR374 / A1M79

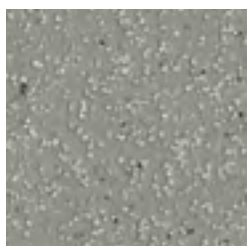

Flurry
PH2012
WR402 / A1M81

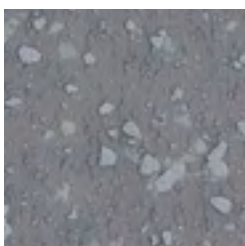

Swordfish
PH2037
WR410 / A1M84

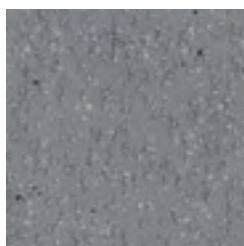

Porpoise
PH2033
WR409 / A1M84



Coyote
PH2015
WR373 / A1M86

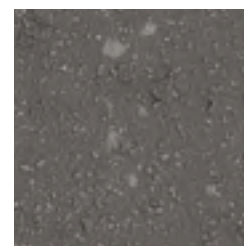

Manatee
PH2016
WR403 / A1M82

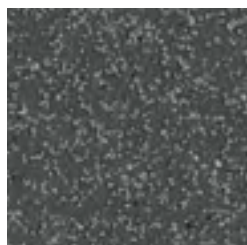

Koala
PH2019
WR404 / A1M82

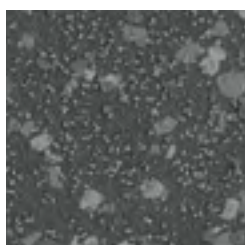

Chipmunk
PH2020
WR232 / A1M82

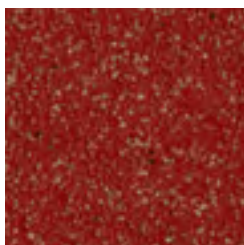

Tulip
PH2032
WR380 / A1M238

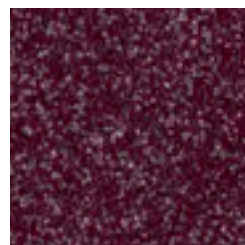

Raisin
PH2040
WR275 / A1M44



Bubble Gum
PH2036
WR276 / A1M276

i **LRV = Light reflectance value**
Please keep LRVs in mind when selecting flooring for areas with dementia and Alzheimer's patients, seniors or individuals with poor vision.

i Color matched weldrods (WR) and mastics (A1M) are available. You'll find their product codes under product SKUs.



CERTIFIED BY SGS Global Services

6'7" x 65'5"
2m x 20m
Format SHEET
Thickness 2mm .08"

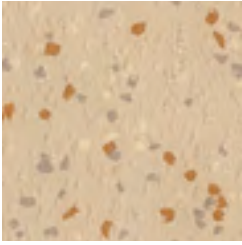

Shore LRV 51
PH2005
WR283 / A1M20

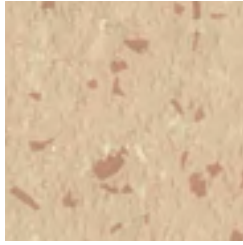

Pony LRV 52
PH2001
WR267 / A1M20



Rye LRV 42
PH2002
WR400 / A1M265

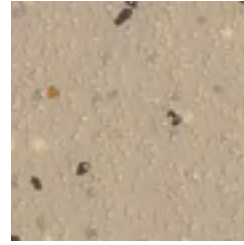

Falcon LRV 40
PH2006
WR401 / A1M20



Quail LRV 30
PH2010
WR279 / A1M20



Owl LRV 40
PH2041
WR20 / A1M20



Colt LRV 23
PH2013
WR282 / A1M239



Caribou LRV 25
PH2009
WR282 / A1M239

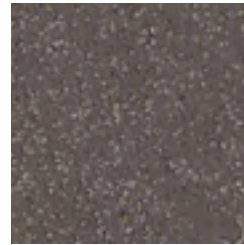

Pine Cone LRV 14
PH2014
WR371 / A1M371



Magma LRV 7
PH2018
WR260 / A1M260

Featured in image right

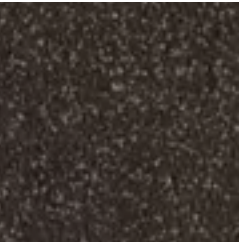

Foal LRV 7
PH2017
WR260 / A1M260

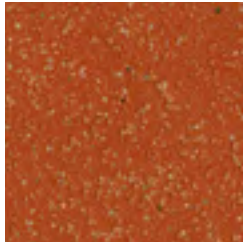

Saffron LRV 15
PH2028
WR406 / A1M42

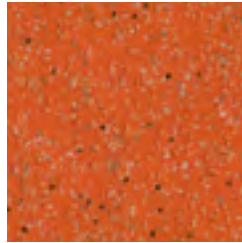

Clementine LRV 20
PH2024
WR273 / A1M273

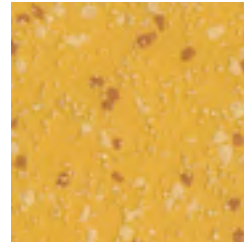

Primrose LRV 42
PH2039
WR411 / A1M378

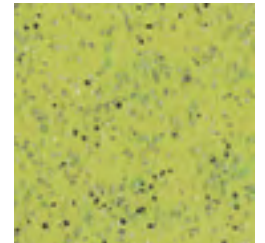

Margarita LRV 42
PH2035
WR381 / A1M381



Looks great with

- Altro Wood
- Altro Operetta
- Altro Walkway 20
- all Altro wall cladding options



Sustainability

- 5% post-consumer recycled content
- O-phthalate free
- Contains bio-based content
- FloorScore certified and low VOC compliant
- Contributes to LEED

More content online www.altro.com



Samples

Experience has shown that printing cannot reproduce colors accurately. If color choice is critical, please request a sample of the material.

Samples are available on altro.com or through Material Bank.

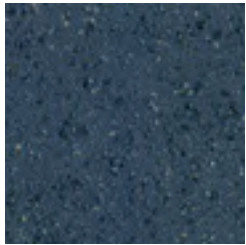

Whirlpool
PH2029
WR407 / A1M73

LRV 10

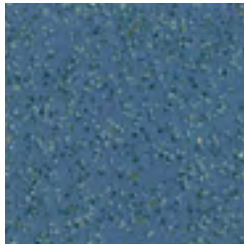

Wildflower
PH2026
WR194 / A1M71

LRV 17

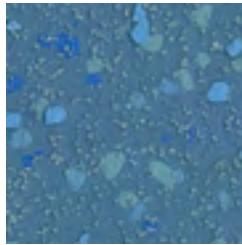

Lakeside
PH2025
WR194 / A1M71

LRV 19

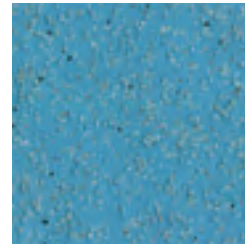

Tidepool
PH2022
WR272 / A1M272

LRV 27

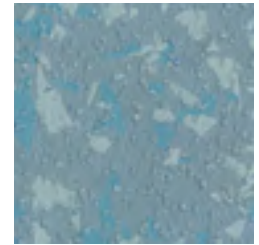

Geyser
PH2021
WR285 / A1M203

LRV 32



Sable
PH2030
WR408 / A1M100

LRV 6



Brook
PH2038
WR376 / A1M302

LRV 14

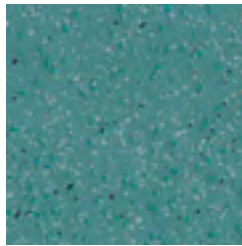

Gulf
PH2034
WR270 / A1M56

LRV 22

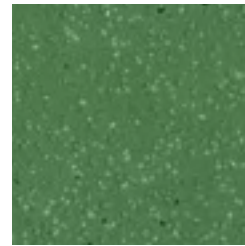

Caterpillar
PH2031
WR377 / A1M308

LRV 19

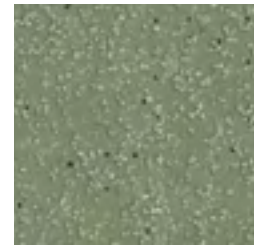

Clover
PH2027
WR262 / A1M154

LRV 25

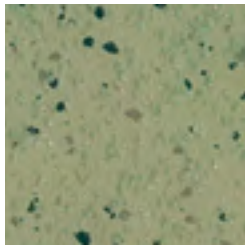

Cantaloupe
PH2023
WR405 / A1M271

LRV 31



i LRV = Light reflectance value

Please keep LRVs in mind when selecting flooring for areas with dementia and Alzheimer's patients, seniors or individuals with poor vision.

i Color matched weldrods (WR) and mastics (A1M) are available. You'll find their product codes under product SKUs.



6'7" x 65'5"
2m x 20m
Format SHEET
Thickness 2mm .08"

Altro Operetta™



Altro Operetta is a robust floor perfect for medium to high-traffic areas. It is easy to clean and maintain and can withstand up to 2,000psi indentation. It has many attractive natural and contemporary colors and finishes to fit your interior design scheme. It matches and coordinates with Altro Orchestra and Altro Serenade to create a complete look throughout.

Combine with our extensive range of Altro wall panels for an attractive and durable floor and wall system.

Typical applications

Healthcare, senior living, education, retail, offices and recreational areas

Features + benefits

- Smooth surface is easy to clean and maintain
- Colors coordinate with Altro Orchestra and Altro Serenade ranges for a complete look throughout
- Meets ISO Class 4 cleanroom requirements
- Resists up to 2,000 psi indentation
- FloorScore Certified / Low VOCs



Looks great with

- Altro Serenade
- Altro Orchestra
- Altro Wood
- Altro Cantata
- Altro Walkway 20
- all Altro wall cladding options



Sustainability

- O-phthalate free
- Contains bio-based content
- FloorScore certified and low VOC compliant
- Contributes to LEED

More content online www.altro.com



Samples

Experience has shown that printing cannot reproduce colors accurately. If color choice is critical, please request a sample of the material.

Samples are available on altro.com or through Material Bank.



Tutti LRV 60
OP2157U
WR500 / A1M136

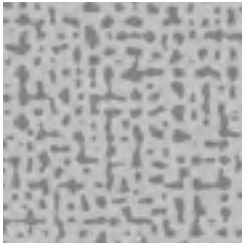

Iris LRV 39
OP2174U
WR513 / A1M85

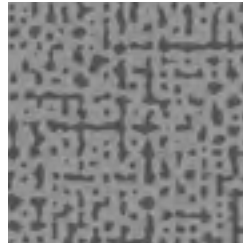

Beethoven LRV 23
OP2159U
WR502 / A1M390

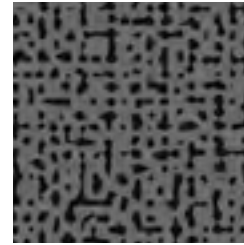

Black Forest LRV 13
OP2158U
WR501 / A1M82

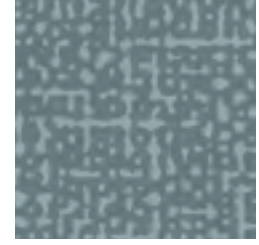

Hurdy Gurdy LRV 24
OP2173U
WR512 / A1M84



Vivo LRV 23
OP2162U
WR494 / A1M494



Fife LRV 57
OP2167U
WR508 / A1M11

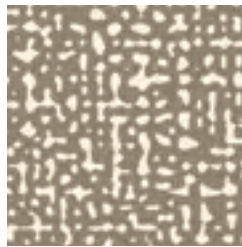

Allegra LRV 38
OP2169U
WR510 / A1M347



Quintet LRV 26
OP2114U
WR435 / A1M390

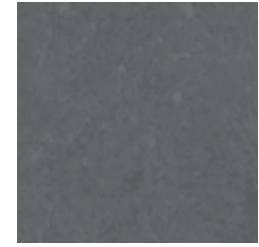

Tempo LRV 17
OP2115U
WR436 / A1M487



Pulse LRV 16
OP2118U
WR439 / A1M84

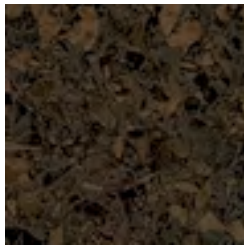

Jig LRV 9
OP2148U
WR62 / A1M62

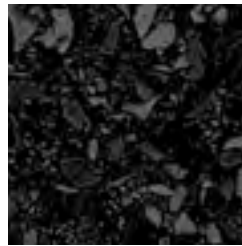

Baron LRV 8
OP2145U
WR485 / A1M485

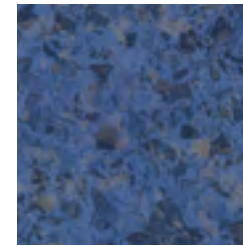

Sonatina LRV 15
OP2147U
WR482 / A1M482

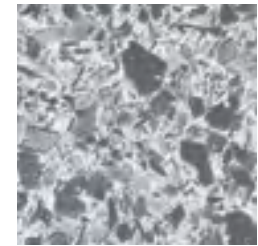

Vagabond LRV 40
OP2141U
WR484 / A1M484

Featured in image left

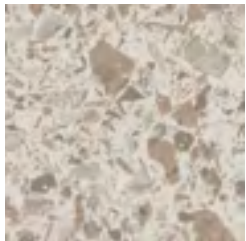

Rondo LRV 44
OP2142U
WR483 / A1M483

Altro recommends carrying out a risk assessment to determine if you should install safety, slip-resistant or smooth flooring. Smooth flooring is not recommended in areas with prolonged contaminants present on floor.

i **LRV = Light reflectance value**
Please keep LRVs in mind when selecting flooring for areas with dementia and Alzheimer's patients, seniors or individuals with poor vision.

i Color matched weldrods (WR) and mastics (A1M) are available. You'll find their product codes under product SKUs.



6'7" x 65'5"
2m x 20m
Format SHEET
Thickness 2mm .08"

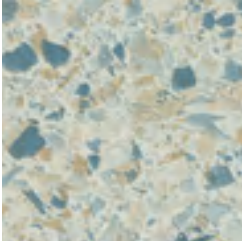

Beat
OP2155U
WR499 / A1M136

LRV 56

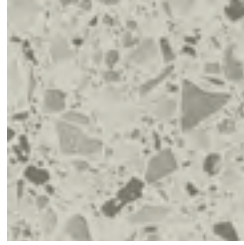

Penzance
OP2153U
WR497 / A1M369

LRV 48

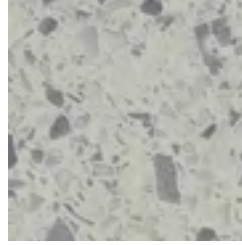

Loco
OP2152U
WR496 / A1M136

LRV 49



Vamp
OP2144U
WR490 / A1M86

LRV 18

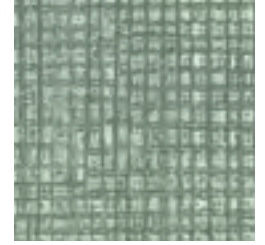

Lulu
OP2128U
WR449 / A1M137

LRV 29



Clef
OP2125U
WR446 / A1M347

LRV 37

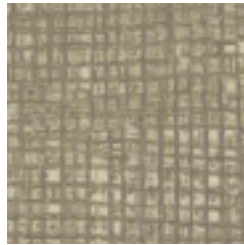

Samson
OP2176U
WR519 / A1M392

LRV 34

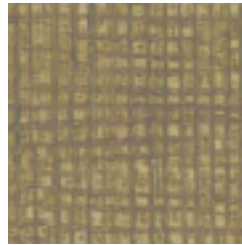

Shell Shack
OP2177U
WR520 / A1M338

LRV 28

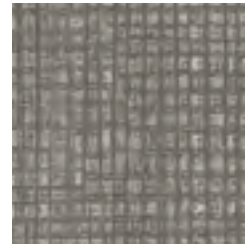

Drop
OP2127U
WR448 / A1M361

LRV 23

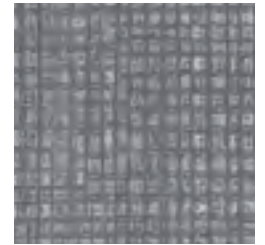

Cannon
OP2129U
WR450 / A1M81

LRV 24

Featured in image right

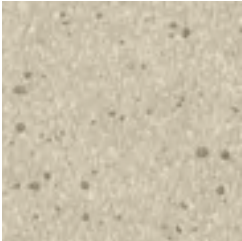

Glee
OP2136U
WR457 / A1M335

LRV 52

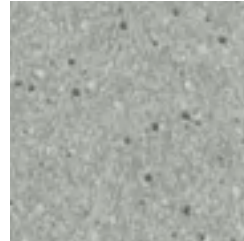

Yeoman
OP2139U
WR460 / A1M484

LRV 39

Featured in image right

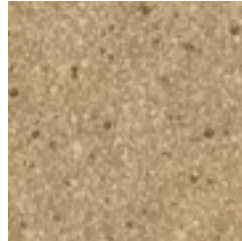

Acapella
OP2135U
WR456 / A1M338

LRV 34

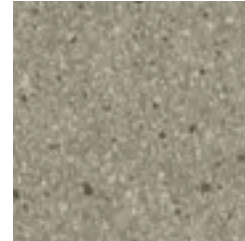

Madrigal
OP2134U
WR455 / A1M361

LRV 31

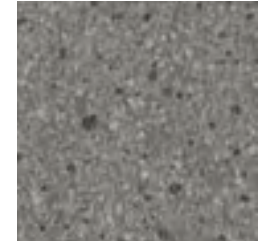

Baroque
OP2133U
WR454 / A1M86

LRV 22



Lola
OP2178U
WR391 / A1M82

LRV 17

Altro recommends carrying out a risk assessment to determine if you should install safety, slip-resistant or smooth flooring. Smooth flooring is not recommended in areas with prolonged contaminants present on floor.



Looks great with

- Altro Serenade
- Altro Orchestra
- Altro Wood
- Altro Cantata
- Altro Walkway 20
- all Altro wall cladding options



Sustainability

- O-phthalate free
- Contains bio-based content
- FloorScore certified and low VOC compliant
- Contributes to LEED

More content online www.altro.com



Samples

Experience has shown that printing cannot reproduce colors accurately. If color choice is critical, please request a sample of the material.

Samples are available on altro.com or through Material Bank.



Altro Operetta shown in Glee and Acapella



Altro Orchestra™



For areas where comfort and sound reduction are important, 2.85mm Altro Orchestra has been engineered to create the ideal environment to learn and live. At the same time, the integrated impact sound insulation system cuts impact sound by up to 15dB.

Altro Orchestra offers comfort underfoot, making life easier on the feet of students, patients and particularly hard-working staff who spend countless hours on the move.

With a palette full of colors and designs varying from calming neutrals reflecting tones of nature, to vibrant shades, Altro Orchestra allows you to create the right atmosphere every time.

Typical applications

Healthcare, senior living, education, retail, offices, light gym and recreational areas



Looks great with

- Altro Serenade
- Altro Operetta
- Altro Wood Comfort
- Altro Cantata
- Altro Reliance 25
- all Altro wall cladding options



Sustainability

- O-phthalate free
- Contains bio-based content
- FloorScore certified and low VOC compliant
- Contributes to LEED

[More content online www.altro.com](http://www.altro.com)



Samples

Experience has shown that printing cannot reproduce colors accurately. If color choice is critical, please request a sample of the material.

Samples are available on altro.com or through Material Bank.



Aurora
CH2857U
WR500 / A1M136

LRV 60

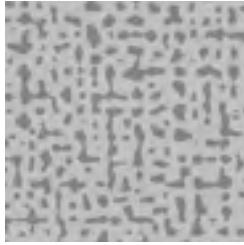

Reed
CH2874U
WR513 / A1M85

LRV 39

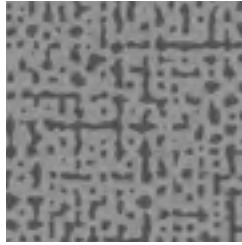

Polka
CH2859U
WR502 / A1M390

LRV 23

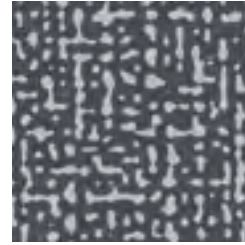

Cornet
CH2864U
WR506 / A1M82

LRV 20

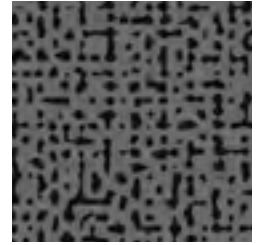

Figaro
CH2858U
WR501 / A1M82

LRV 13

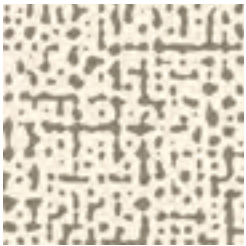

Macavity
CH2867U
WR508 / A1M11

LRV 57



Seville
CH2860U
WR503 / A1M79

LRV 45

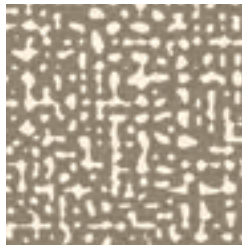

Sitar
CH2869U
WR510 / A1M347

LRV 38

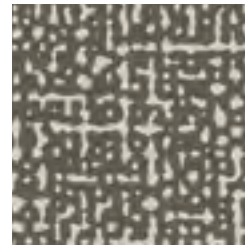

Tosca
CH2862U
WR494 / A1M494

LRV 23

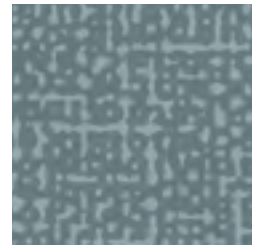

Nabucco
CH2873U
WR512 / A1M84

LRV 24

Featured in image left

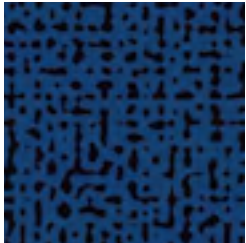

Kora
CH2871U
WR495 / A1M495

LRV 8



Chant
CH2814U
WR435 / A1M390

LRV 26



Club
CH2815U
WR436 / A1M487

LRV 17

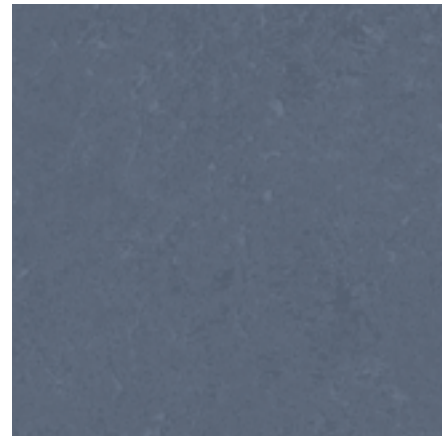

Metal
CH2818U
WR439 / A1M84

LRV 16

Altro recommends carrying out a risk assessment to determine if you should install safety, slip-resistant or smooth flooring. Smooth flooring is not recommended in areas with prolonged contaminants present on floor.



LRV = Light reflectance value

Please keep LRVs in mind when selecting flooring for areas with dementia and Alzheimer's patients, seniors or individuals with poor vision.



Color matched weldrods (WR) and mastics (A1M) are available. You'll find their product codes under product SKUs.



Altro Orchestra achieves 15dB in sound reduction - ISO 10140.



CEPITRO BY PCS Global Services

6'7" x 65'5"
2m x 20m
Format SHEET
Thickness 2.85mm .11"

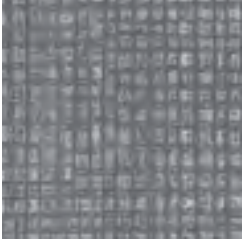

Cello
CH2829U
WR450 / A1M81

LRV 24

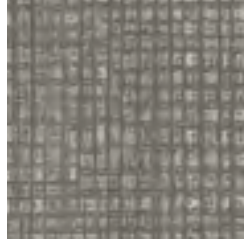

Glockenspiel
CH2827U
WR448 / A1M361

LRV 23



Trumpet
CH2825U
WR446 / A1M347

LRV 37

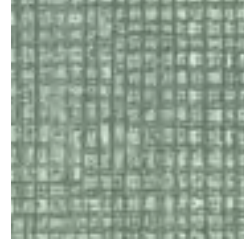

Guitar
CH2828U
WR449 / A1M137

LRV 29

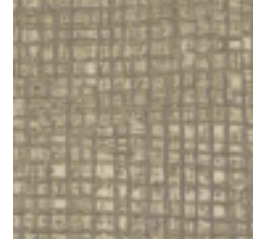

Rigoletto
CH2876U
WR519 / A1M392

LRV 34

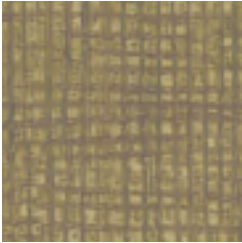

Traviata
CH2877U
WR520 / A1M338

LRV 28

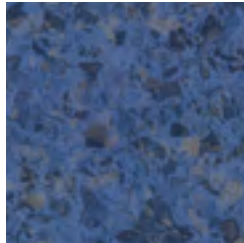

Turnadot
CH2847U
WR482 / A1M482

LRV 15

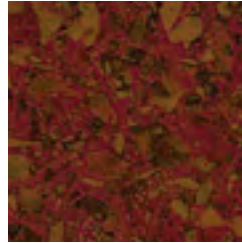

Orfeo
CH2849U
WR41 / A1M41

LRV 9



Othello
CH2848U
WR62 / A1M62

LRV 9

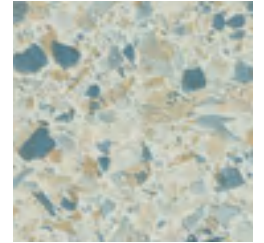

Maraca
CH2855U
WR499 / A1M136

LRV 56

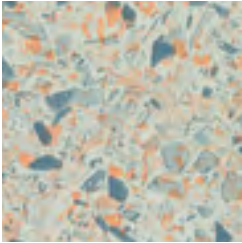

Serpent
CH2850U
WR517 / A1M136

LRV 56



Brass
CH2842U
WR483 / A1M483

LRV 44

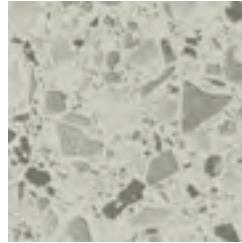

Notturna
CH2853U
WR497 / A1M369

LRV 48

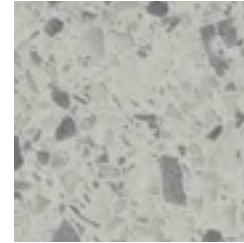

Chromatic
CH2852U
WR496 / A1M136

LRV 49

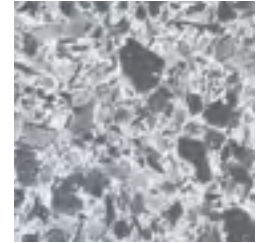

String
CH2841U
WR484 / A1M484

LRV 40



Looks great with

- Altro Serenade
- Altro Operetta
- Altro Wood Comfort
- Altro Cantata
- Altro Reliance 25
- all Altro wall cladding options



Sustainability

- O-phthalate free
- Contains bio-based content
- FloorScore certified and low VOC compliant
- Contributes to LEED

More content online www.altro.com



Samples

Experience has shown that printing cannot reproduce colors accurately. If color choice is critical, please request a sample of the material.

Samples are available on altro.com or through Material Bank.

Featured in image below

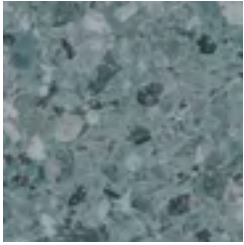

Percussion
CH2844U
WR490 / A1M86

LRV 18

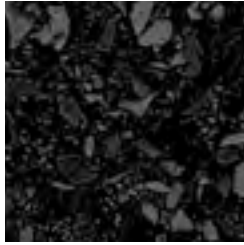

Montezuma
CH2845U
WR485 / A1M485

LRV 8

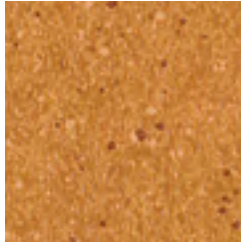

Bongo
CH2840U
WR461 / A1M152

LRV 27

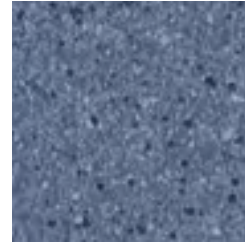

Drum
CH2837U
WR458 / A1M74

LRV 18

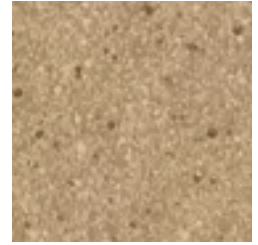

Oboe
CH2835U
WR456 / A1M338

LRV 34

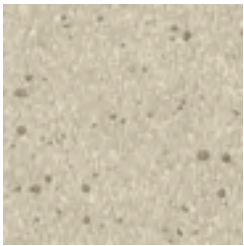

Chimes
CH2836U
WR457 / A1M335

LRV 52

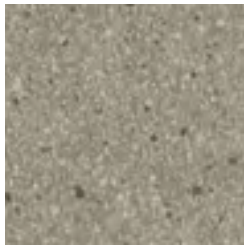

Violin
CH2834U
WR455 / A1M361

LRV 31

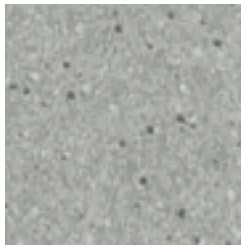

Trombone
CH2839U
WR460 / A1M484

LRV 39

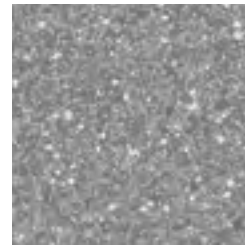

Conga
CH2879U
WR390 / A1M390

LRV 30

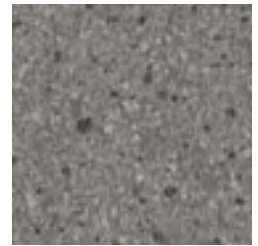

Flute
CH2833U
WR454 / A1M86

LRV 22

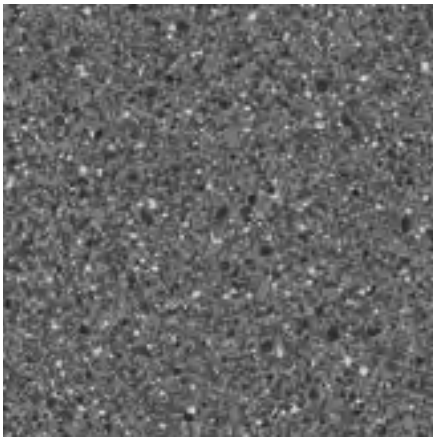

Manon
CH2878U
WR391 / A1M82

LRV 17



Altro recommends carrying out a risk assessment to determine if you should install safety, slip-resistant or smooth flooring. Smooth flooring is not recommended in areas with contaminants on the floor.



LRV = Light reflectance value

Please keep LRVs in mind when selecting flooring for areas with dementia and Alzheimer's patients, seniors or individuals with poor vision.



Color matched weldrods (WR) and mastics (A1M) are available. You'll find their product codes under product SKUs.



Altro Orchestra achieves 15dB in sound reduction - ISO 10140.



CERTIFIED BY PCS Global Services

6'7" x 65'5"
2m x 20m
Format SHEET
Thickness 2.85mm .11"



Altro Serenade™



Silence is golden. Whether softening the sounds of little feet or maximizing privacy at work or leisure, acoustic Altro Serenade is more than up to the task. At 3.9mm thick with 19dB impact sound insulation and an IIC rating of 54, not only does it reduce noise, it provides a high level of comfort underfoot, making it a great solution for well-used spaces.

All Altro Serenade color and design options have a match in the Altro Orchestra and Altro Operetta ranges.

Typical applications

Healthcare, senior living, education, retail, offices, light gym and recreational areas

Features + benefits

- Smooth surface is easy to clean and maintain
- Provides ample comfort underfoot
- 19dB sound reduction and an IIC rating of 54
- Colors coordinate with Altro Orchestra and Altro Operetta ranges for a complete look throughout
- FloorScore Certified / Low VOCs



Looks great with

- Altro Operetta
- Altro Orchestra
- Altro Wood Acoustic
- Altro Cantata
- Altro Lavencia LVT
- all Altro wall cladding options



Sustainability

- O-phthalate free
- Contains bio-based content
- FloorScore certified and low VOC compliant
- Contributes to LEED

More content online www.altro.com



Samples

Experience has shown that printing cannot reproduce colors accurately. If color choice is critical, please request a sample of the material.

Samples are available on altro.com or through Material Bank.



Bohemia LRV 44
SE3942U
WR483 / A1M483

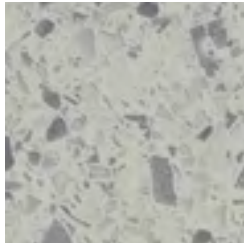

Romeo LRV 49
SE3952U
WR496 / A1M136



Scarlatti LRV 18
SE3944U
WR490 / A1M86

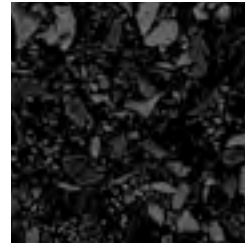

Bandola LRV 8
SE3945U
WR485 / A1M485

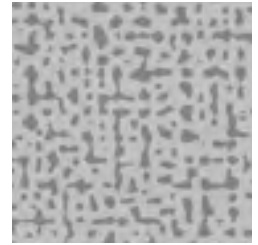

Torch LRV 39
SE3974U
WR513 / A1M85

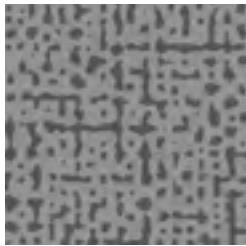

Bolero LRV 23
SE3959U
WR502 / A1M390

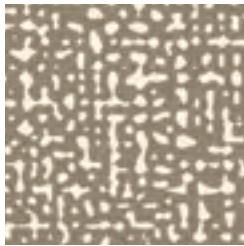

Charm LRV 38
SE3969U
WR510 / A1M347



Elgar LRV 23
SE3962U
WR494 / A1M494

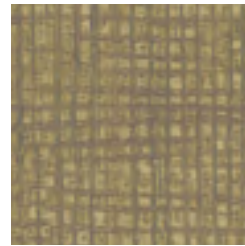

Scale LRV 28
SE3977U
WR520 / A1M338

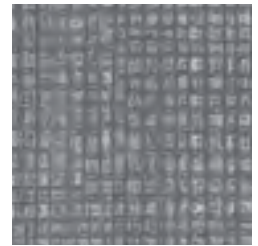

Encore LRV 24
SE3929U
WR450 / A1M81

Featured in image left

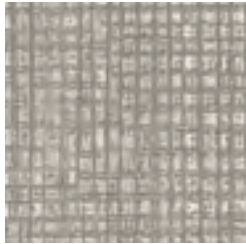

March LRV 37
SE3925U
WR446 / A1M347

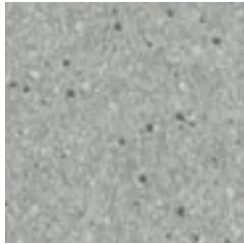

Caldara LRV 39
SE3939U
WR460 / A1M484

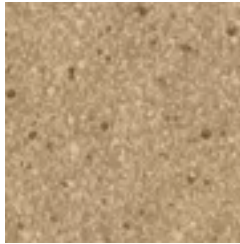

Adagio LRV 34
SE3935U
WR456 / A1M338

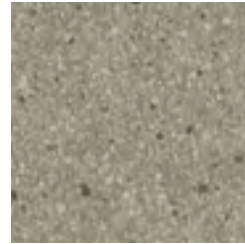

Chord LRV 31
SE3934U
WR455 / A1M361

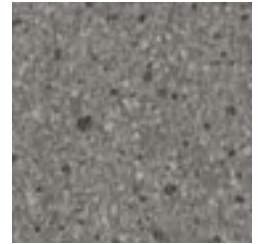

Anthem LRV 22
SE3933U
WR454 / A1M86



Metronome LRV 26
SE3914U
WR435 / A1M390

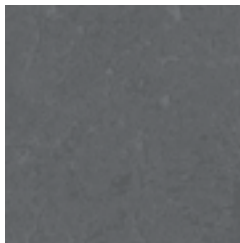

Octave LRV 17
SE3915U
WR436 / A1M487

i **LRV = Light reflectance value**
Please keep LRVs in mind when selecting flooring for areas with dementia and Alzheimer's patients, seniors or individuals with poor vision.

i Color matched weldrods (WR) and mastics (A1M) are available. You'll find their product codes under product SKUs.

👂 Altro Serenade achieves 19dB in sound reduction (ISO 10140) and an IIC rating of 54.



6'7" x 65'5"
2m x 20m
Format SHEET
Thickness 3.9mm .15"

Altro Wood™

Nethercrest Nursing Home



Altro Wood is an attractive, general purpose 2mm wood-look flooring available in a range of designs with different plank sizes and shades. These include a fine-line design, a classic wide plank and rustic designs, which help create the right look for areas where people live and work.

It's not just about looks though: Altro Wood is designed to cope with the medium to heavy traffic you would expect in busy environments. It is also a perfect partner for a variety of wall shades and finishes, from wall cladding to metal and glass, making design coordination simpler.

Typical applications

Healthcare, senior living, education, retail, offices and recreational areas



Looks great with

- Altro Wood Comfort
- Altro Wood Acoustic
- Altro Wood adhesive-free
- Altro Operetta
- Altro Walkway 20
- all Altro wall cladding options



Sustainability

- O-phthalate free
- Contains bio-based content
- FloorScore certified and low VOC compliant
- Contributes to LEED

[More content online www.altro.com](http://www.altro.com)



Samples

Experience has shown that printing cannot reproduce colors accurately. If color choice is critical, please request a sample of the material.

Samples are available on altro.com or through Material Bank.

Features + benefits

- Smooth surface is easy to clean and maintain
- Authentic wood visual creates warm and inviting setting
- Impressive range of designs with different planks and shades available
- Resists up to 2,500 psi indentation
- Allows coordination with Altro Wood Comfort and Altro Wood Acoustic ranges for smooth transition between areas requiring different levels of slip resistance and sound absorption
- FloorScore Certified / Low VOCs

Featured in image left



Bleached Oak LRV 52
WSM2051
WR335 / A1M335



Castle Oak LRV 51
WSM2075
WR335 / A1M335



Washed Oak LRV 38
WSM2063
WR347 / A1M347



Farmhouse Oak LRV 38
WSM2054
WR338 / A1M338



Vintage Cherry LRV 22
WSM2052
WR336 / A1M239



Worn Oak LRV 19
WSA2023
WR322 / A1M239



Tower Oak LRV 19
WSM2077
WR322 / A1M239



Manor Oak LRV 7
WSM2064
WR348 / A1M348



Blcd. Bamboo LRV 42
WSM2074
WR463 / A1M392



Honey Beech LRV 43
WSM2071
WR462 / A1M462

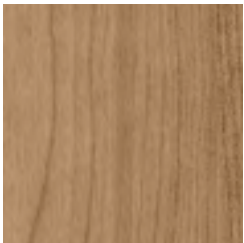

Autumn Maple LRV 24
WSM2055
WR339 / A1M339

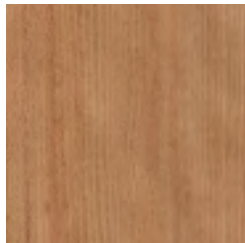

Spring Maple LRV 27
WSA2018
WR352 / A1M352

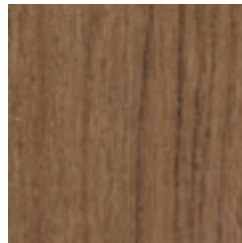

Urban Cherry LRV 17
WSM2053
WR337 / A1M337

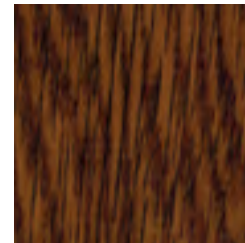

Imperial Oak LRV 17
WSM2078
WR467 / A1M467

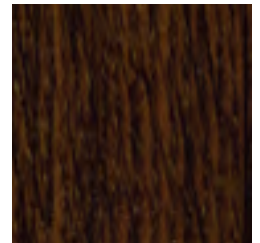

Sovereign Oak LRV 10
WSM2079
WR468 / A1M62

Altro recommends carrying out a risk assessment to determine if you should install safety, slip-resistant or smooth flooring. Smooth flooring is not recommended in areas with prolonged contaminants present on floor.



LRV = Light reflectance value

Please keep LRVs in mind when selecting flooring for areas with dementia and Alzheimer's patients, seniors or individuals with poor vision.



Color matched weldrods (WR) and mastics (A1M) are available. You'll find their product codes under product SKUs.



CERTIFIED BY
FSC Global Services

6'7" x 65'5"
2m x 20m

Format
SHEET

Thickness
2mm | .08"

Featured in image right

**Rustic Oak**WSM2056
WR340 / A1M340

LRV 37

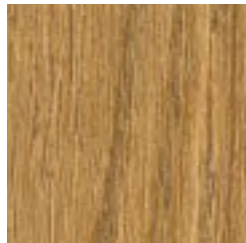
**Oak Traditions**WSM2069
WR353 / A1M225

LRV 25

**Warm Bamboo**WSM2073
WR342 / A1M224

LRV 21

**Mellow Maple**WSM2068
WR352 / A1M352

LRV 27

**Seasoned Cherry**WSM2059
WR343 / A1M246

LRV 15

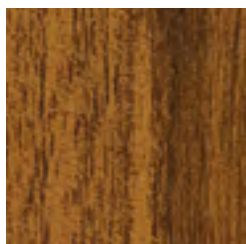
**Antique Walnut**WSM2057
WR341 / A1M160

LRV 15

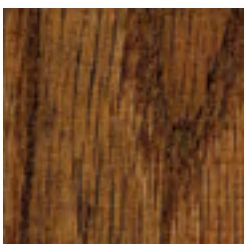
**Great Oak**WSM2076
WR339 / A1M339

LRV 22

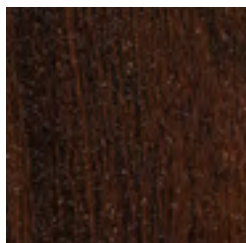
**Walnut Noir**WSM2061
WR345 / A1M62

LRV 6

**Plank and film repeat info for Altro Wood,
Altro Wood Comfort and Altro Wood Acoustic**

Film	Plank length	Plank width	Repeat
Bleached Oak	2 x 500mm	100mm	1m
Rustic Oak			
Oak Traditions			
Washed Oak			
Manor Oak			
Farmhouse Oak			
Autumn Maple	1 x 550mm, 1 x 450mm (Alternating)	100mm	1m
Vintage Cherry			
Seasoned Cherry			
Urban Cherry			
Walnut Noir			
Antique Walnut			
Mellow Maple	3 x 333.3mm	62.5mm	1m
Spring Maple			
Honey Beech	1000mm	125mm	1m
Castle Oak			
Tower Oak			
Great Oak			
Worn Oak	1000mm	166mm	1m
Imperial Oak			
Sovereign Oak	Fine line		1m
Bleached Bamboo	Fine line		1m
Warm Bamboo	Fine line		1m

Altro recommends carrying out a risk assessment to determine if you should install safety, slip-resistant or smooth flooring.
Smooth flooring is not recommended in areas with prolonged contaminants present on floor.

**Looks great with**

- Altro Wood Comfort
- Altro Wood Acoustic
- Altro Wood adhesive-free
- Altro Operetta
- Altro Walkway 20
- all Altro wall cladding options

**Sustainability**

- O-phthalate free
- Contains bio-based content
- FloorScore certified and low VOC compliant
- Contributes to LEED

[More content online www.altro.com](http://www.altro.com)

**Samples**

Experience has shown that printing cannot reproduce colors accurately. If color choice is critical, please request a sample of the material.

Samples are available on altro.com or through Material Bank.



Altro Wood shown in Rustic Oak



Altro Wood™ Comfort

Prestonfield Nursery School



Altro Wood Comfort is an ideal choice for areas that need to look good while providing comfort underfoot. This 2.85mm thick option offers 15dB sound reduction, which is great for noisy environments such as healthcare and education settings. For an acoustic option, please see Altro Wood Acoustic.

With matching design and color options across this range as well as two other wood-look ranges, you can achieve a consistent look throughout with technical performance tailored to each area's specific needs.

Typical applications

Healthcare, senior living, education, retail, offices, light gym and recreational areas

Features + benefits

- 2.85mm thick
- Provides ample comfort underfoot
- 15dB sound reduction, ideal for noisy environments such as healthcare and educational settings
- Allows coordination with Altro Wood and Altro Wood Acoustic ranges for smooth transition between areas requiring different levels of slip resistance and sound absorption
- Resists up to 1,000 psi indentation
- FloorScore Certified / Low VOCs



Looks great with

- Altro Wood
- Altro Wood Acoustic
- Altro Wood adhesive-free
- Altro Orchestra
- Altro Reliance 25
- all Altro wall cladding options



Sustainability

- O-phthalate free
- Contains bio-based content
- FloorScore certified and low VOC compliant
- Contributes to LEED

[More content online www.altro.com](http://www.altro.com)



Samples

Experience has shown that printing cannot reproduce colors accurately. If color choice is critical, please request a sample of the material.

Samples are available on altro.com or through Material Bank.

Featured in image left



Castle Oak Comfort
WSMSC2816
WR335 / A1M335 LRV 51



Washed Oak Comfort
WSMSC2808
WR347 / A1M347 LRV 38



Blchd. Bamboo Comfort
WSMSC2815
WR463 / A1M392 LRV 42



Farmhouse Oak Comfort
WSMSC2811
WR338 / A1M338 LRV 38



Autumn Maple Comfort
WSMSC2802
WR339 / A1M339 LRV 24



Vintage Cherry Comfort
WSMSC2803
WR336 / A1M239 LRV 22

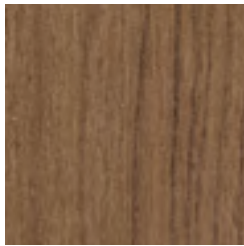

Urban Cherry Comfort
WSMSC2804
WR337 / A1M337 LRV 17



Antique Walnut Comfort
WSMSC2810
WR341 / A1M160 LRV 15



Great Oak Comfort
WSMSC2817
WR339 / A1M339 LRV 22

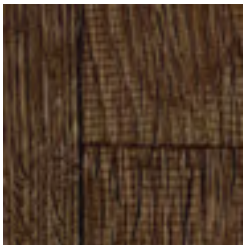

Tower Oak Comfort
WSMSC2818
WR322 / A1M239 LRV 19

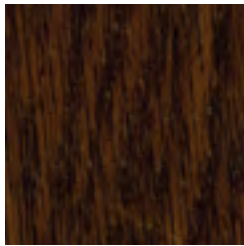

Sovereign Oak Comfort
WSMSC2820
WR468 / A1M62 LRV 10



Rustic Oak Comfort
WSMSC2805
WR340 / A1M340 LRV 37

Altro recommends carrying out a risk assessment to determine if you should install safety, slip-resistant or smooth flooring. Smooth flooring is not recommended in areas with prolonged contaminants present on floor.

i **LRV = Light reflectance value**
Please keep LRVs in mind when selecting flooring for areas with dementia and Alzheimer's patients, seniors or individuals with poor vision.

i Color matched weldrods (WR) and mastics (A1M) are available. You'll find their product codes under product SKUs.

👂 Altro Wood Comfort achieves 15dB in sound reduction - ISO 10140.



6'7" x 65'5" 2m x 20m
Format SHEET
Thickness 2.85mm .11"



Altro Wood™ Acoustic



Altro Wood Acoustic provides a warm and homey aesthetic with the additional benefit of 19dB sound reduction and an IIC rating of 54, ideal for multi-level construction. At 3.9mm thick, it can tolerate medium to heavy duty traffic and is perfect for environments where people are on their feet often and need comfort underfoot.

With matching design and color options across this range as well as two other wood-look ranges, you can achieve a consistent look throughout with technical performance tailored to each area's specific needs.

Typical applications

Healthcare, senior living, education, retail, offices, light gym and recreational areas

Features + benefits

- Provides ample comfort underfoot
- 3.9mm thick
- 19dB sound reduction
- IIC rating of 54
- Ideal for multi-level construction with medium to heavy traffic between floors
- Allows coordination with Altro Wood and Altro Wood Comfort ranges for smooth transition between areas requiring different levels of slip resistance and sound absorption
- FloorScore Certified / Low VOCs



Looks great with

- Altro Wood
- Altro Wood Comfort
- Altro Wood adhesive-free
- Altro Serenade
- Altro Stronghold 30
- all Altro wall cladding options



Sustainability

- O-phthalate free
- Contains bio-based content
- FloorScore certified and low VOC compliant
- Contributes to LEED

[More content online www.altro.com](http://www.altro.com)



Samples

Experience has shown that printing cannot reproduce colors accurately. If color choice is critical, please request a sample of the material.

Samples are available on altro.com or through Material Bank.



Castle Oak Acoustic
WSMA3798
WR335 / A1M335 **LRV 51**



Blchd. Bamboo Acoustic
WSMA3797
WR463 / A1M392 **LRV 42**

Featured in image left



Farmhouse Oak Acoustic **LRV 38**
WSMA3781
WR338 / A1M338



Mellow Maple Acoustic
WSMA3795
WR352 / A1M352 **LRV 27**



Antique Walnut Acoustic
WSMA3782
WR341 / A1M160 **LRV 15**



Sovereign Oak Acoustic **LRV 10**
WSMA37102
WR468 / A1M62

Altro recommends carrying out a risk assessment to determine if you should install safety, slip-resistant or smooth flooring. Smooth flooring is not recommended in areas with prolonged contaminants present on floor.

i **LRV = Light reflectance value**
Please keep LRVs in mind when selecting flooring for areas with dementia and Alzheimer's patients, seniors or individuals with poor vision.

i Color matched weldrods (WR) and mastics (A1M) are available. You'll find their product codes under product SKUs.

👂 Altro Wood Acoustic achieves 19dB in sound reduction (ISO 10140) and an IIC rating of 54.



6'7" x 65'5"
2m x 20m
Format SHEET
Thickness 3.9mm .15"



Altro Lavencia™

The Mooring on Foreside



Attractive looks and lasting durability are not the only traits that make Altro Lavencia the premier LVT for commercial applications — Altro Lavencia is now proudly manufactured in the USA!

Available in an assortment of updated films ranging from classic wood tones, coordinating stones, brights and even modern organic looks, Altro Lavencia is a stylish, low-maintenance option for a host of application areas.

Peak beauty and performance will last through its lifetime, even in areas with consistently heavy traffic, thanks to the commercial-grade UV-cured ceramic reinforced urethane finish and 28 mil wear layer.

Typical applications

Schools, colleges, offices, government buildings, senior living, public housing, apartment communities, retail, dining rooms



Looks great with

- Altro Classic 25
- Altro Reliance 25
- Altro Wood Comfort
- Altro Orchestra
- all Altro wall cladding options



Sustainability

- 100% recyclable
- O-phthalate free
- FloorScore certified and low VOC compliant
- Contributes to LEED

[More content online www.altro.com](http://www.altro.com)



Samples

Experience has shown that printing cannot reproduce colors accurately. If color choice is critical, please request a sample of the material.

Samples are available on altro.com or through Material Bank.

Features + benefits

- 3mm thick, 28 mil wear layer
- UV-cured, ceramic reinforced finish
- Glue-down installation
- Resists up to 2000psi of indentation
- Easy-to-clean, no finish required
- Square edge construction - means no bevel for dirt to hide in
- FloorScore Certified
- Ortho-phthalate-free
- Made in the USA
- Custom build options available



These select colors, up to 20,000 square feet, will process and ship within 3 business days.

Featured in image left



Pale Persimmon LRV 49
LAV55044

6" x 48"



Chateau Nordic LRV 43
LAV13011

9.25" x 59.25"



Birch Grove LRV 41
LAV55011

6" x 48"



Hampton Shores LRV 38
LAV99022

6" x 48"



Hampton Greige LRV 25
LAV23066

6" x 48"



Tuxedo Bamboo LRV 43
LAV15033

6" x 48"

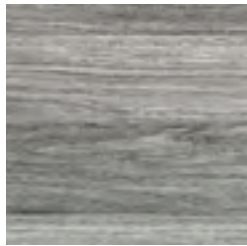

Ansel Oak LRV 27
LAV14044

6" x 48"



Persimmon LRV 19
LAV55077

6" x 48"



Farm. Heritage LRV 19
LAV66099

6" x 48"



Blk. Persimmon LRV 8
LAV55055

6" x 48"

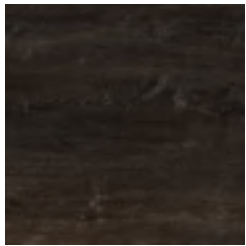

Tavern Mesquite LRV 8
LAV55088

9.25" x 59.25"



Blonde Oak LRV 58
LAV14033

6" x 48"

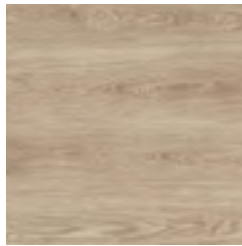

Classic Oak LRV 40
LAV14011

6" x 48"

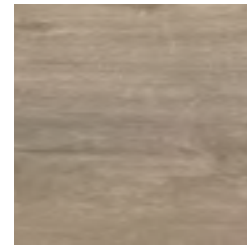

Ash Oak LRV 54
LAV14022

6" x 48"



Farm. Whiskey LRV 31
LAV13066

6" x 48"

Plank length	Amount per carton
6" x 48"	18 pieces per carton 36 ft ² per carton
9.25" x 59.25"	10 pieces per carton 38.07 ft ² per carton
12" x 24"	18 pieces per carton 36 ft ² per carton

Additional colors of Altro Lavencia LVT on reverse

Altro recommends carrying out a risk assessment to determine if you should install safety, slip-resistant or smooth flooring. Smooth flooring is not recommended in areas with prolonged contaminants present on floor.



Format PLANK + TILE
Thickness 3mm .12"



Farm. Smoke
LAV13077

LRV 26

6" x 48"

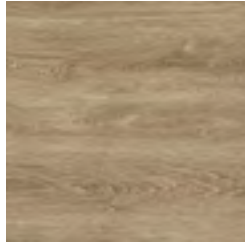

Oak Butternut
LAV88077

LRV 26

9.25" x 59.25"



Laurel Oak
LAV88011

LRV 21

6" x 48"

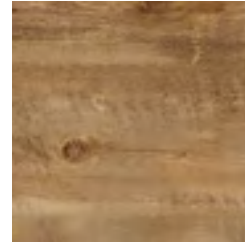

Chateau Saddle
LAV13033

LRV 26

6" x 48"



Soft Bamboo
LAV15022

LRV 33

6" x 48"



Chateau Cellar
LAV13022

LRV 21

6" x 48"

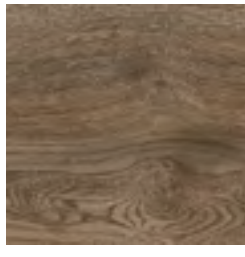

Newfound Oak
LAV14055

LRV 21

6" x 48"



Country Hickory
LAV88033

LRV 38

6" x 48"



Warm Walnut
LAV55022

LRV 21

6" x 48"



Spalted Cherry
LAV88088

LRV 17

6" x 48"

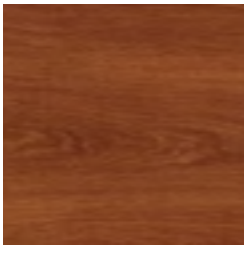

Afr. Mahogany
LAV88044

LRV 12

6" x 48"

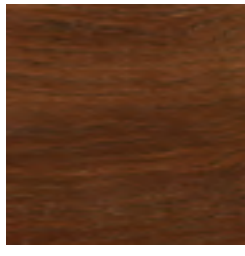

Ant. Burled Oak
LAV88066

LRV 12

6" x 48"

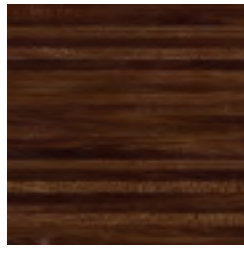

Rich Bamboo
LAV15011

LRV 7

6" x 48"

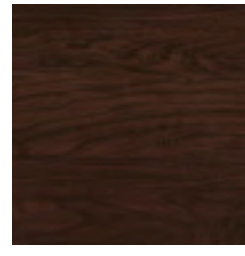

American Walnut
LAV88022

LRV 8

6" x 48"



Mal. Blackwood
LAV99066

LRV 9

9.25" x 59.25"



Looks great with

- Altro Classic 25
- Altro Reliance 25
- Altro Wood Comfort
- Altro Orchestra
- all Altro wall cladding options



Sustainability

- 100% recyclable
- O-phthalate free
- FloorScore certified and low VOC compliant
- Contributes to LEED

More content online www.altro.com



Samples

Experience has shown that printing cannot reproduce colors accurately. If color choice is critical, please request a sample of the material.

Samples are available on altro.com or through Material Bank.



These select colors, up to 20,000 square feet, will process and ship within 3 business days.



Tavern Tobacco LRV 17
LAV99055

6" x 48"

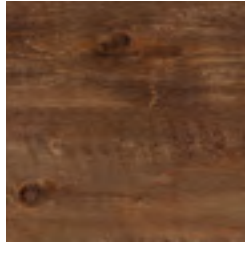

Frontier LRV 15
LAV23088

6" x 48"



Vintage Walnut LRV 10
LAV99077

9.25" x 59.25"

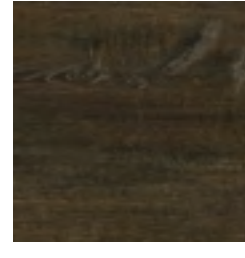

Tavern Bourbon LRV 10
LAV99088

9.25" x 59.25"

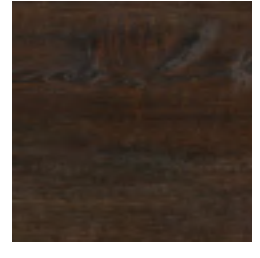

Rustic Chestnut LRV 12
LAV99033

9.25" x 59.25"



Pear LRV 37
LAV44044

6" x 48"



Amber LRV 51
LAV44011

6" x 48"



Marmalade LRV 24
LAV44022

6" x 48"

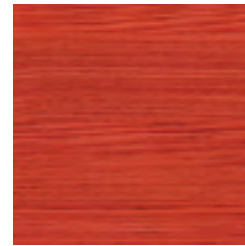

Crimson LRV 12
LAV44033

6" x 48"



Cobalt LRV 10
LAV44055

6" x 48"

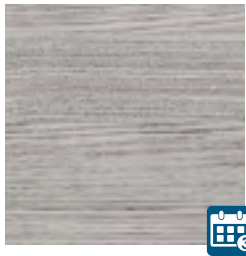

Dove LRV 37
LAV17011

6" x 48"



Tweed LRV 22
LAV17022

6" x 48"

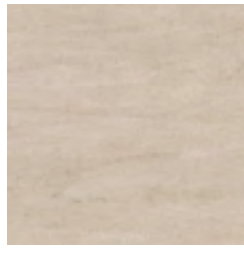

Alabaster LRV 48
LAV16033

12" x 24"



Sterling LRV 24
LAV16022

12" x 24"



Asher LRV 10
LAV16044

12" x 24"

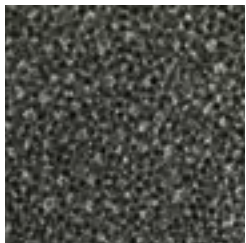

Hammered Steel LRV 8
LAV16011

12" x 24"

Plank length	Amount per carton
6" x 48"	18 pieces per carton 36 ft ² per carton
9.25" x 59.25"	10 pieces per carton 38.07 ft ² per carton
12" x 24"	18 pieces per carton 36 ft ² per carton



Format PLANK + TILE
Thickness 3mm .12"

Altro Quartz Tile™

Winslow Junior High School



Altro Quartz Tile is a homogeneous tile available in chip and marble patterns, providing endless design options for commercial, industrial or public sector applications. Static load testing that exceeds 3000 psi proves Altro Quartz Tile is ideal for heavy pedestrian traffic areas. These tiles are occupancy ready, eliminating the need for initial application of floor finish.

Generate school spirit by pairing logos and colors or improve company morale with vibrant hues that inspire vitality throughout the office.

Typical applications

Schools, hallways, classrooms, cafeterias, lobbies, waiting rooms, retail, supermarkets, cafes, office buildings, general circulation areas, warehouse and industrial areas, forklift trafficked areas



Looks great with

- Altro Lavencia LVT
- Altro Walkway 20
- Altro Operetta
- Altro Wood
- all Altro wall cladding options



Sustainability

- O-phthalate free
- Contains bio-based content
- Low VOC compliant
- Contributes to LEED

[More content online www.altro.com](http://www.altro.com)



Samples

Experience has shown that printing cannot reproduce colors accurately. If color choice is critical, please request a sample of the material.

Samples are available on altro.com or through Material Bank.

Features + benefits

- Homogeneous construction, available in chip and striated patterns
- Static load limit of 3,000 psi
- Easier and faster to install than VCT
- Occupancy ready, no finish required
- 70% quartz content for extreme durability
- PUR coating – easy to maintain and better cleanability compared to non PUR treated products
- Low VOCs



Sand CD
9322



Sand
9722

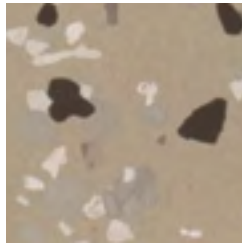

Celery CD
9361

Featured in image left

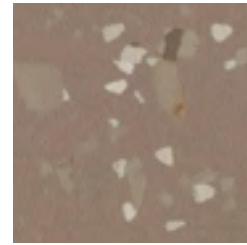

Shale CD
9324



Shale
9724



Cream CD
9321

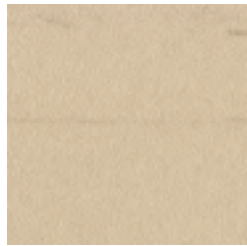

Cream
9721



Latte CD
9323

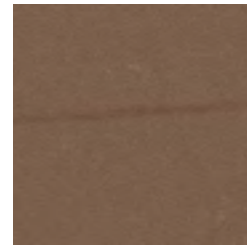

Latte
9723



Espresso CD
9328



Lemongrass CD
9363



Sunglow CD
9329



Curry CD
9325



Terracotta CD
9344

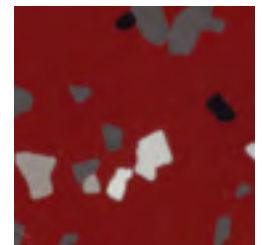

Firecracker CD
9349

Additional colors of Altro Quartz Tile on reverse

Altro recommends carrying out a risk assessment to determine if you should install safety, slip-resistant or smooth flooring. Smooth flooring is not recommended in areas with prolonged contaminants present on floor.

New colors arriving later this year

Check our website, altro.com, for the new color palette and looks later in 2021

	24" x 24"
	61cm x 61cm
	Format TILE
	Thickness 2mm .08"

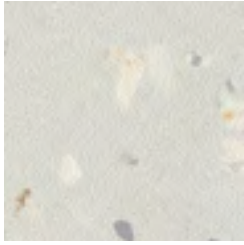

Chalk CD
9301



Chalk
9701



Rock Salt CD
9302



Rock Salt
9702

Featured in image right



Ice CD
9351



Slate CD
9353

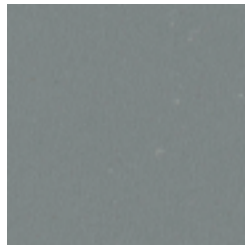

Slate
9753



Ash CD
9303



Ash
9703

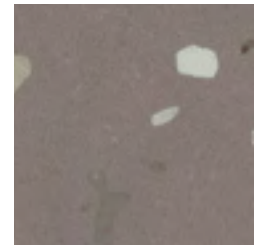

Platinum CD
9317

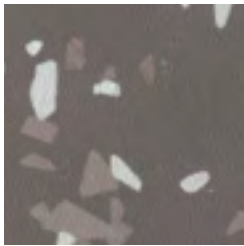

Thunder CD
9318

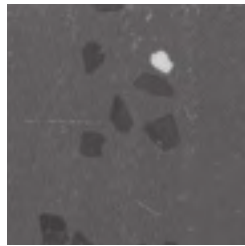

Steel CD
9304

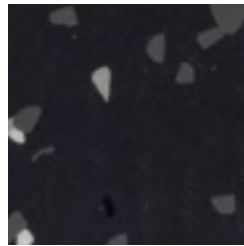

Charcoal CD
9306

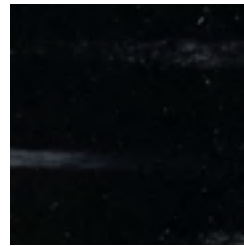

Onyx
9719



Onyx CD
9319



Looks great with

- Altro Lavencia LVT
- Altro Walkway 20
- Altro Operetta
- Altro Wood
- all Altro wall cladding options



Sustainability

- O-phthalate free
- Contains bio-based content
- Low VOC compliant
- Contributes to LEED

[More content online www.altro.com](http://www.altro.com)



Samples

Experience has shown that printing cannot reproduce colors accurately. If color choice is critical, please request a sample of the material.

Samples are available on altro.com or through Material Bank.



Fern CD
9367



Moss CD
9366

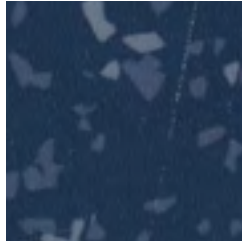

Ocean CD
9359

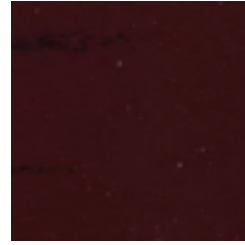

Garnet
9770

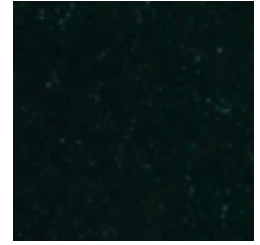

Emerald
9772



Citrine
9773



Coral
9774



Lapis
9775

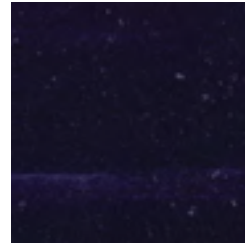

Amethyst
9771

Featured in image below

Upper Moreland High School - water jet logo with Altro Quartz Tile



New colors arriving later this year

Check our website, altro.com, for the new color palette and looks later in 2021



24" x 24" 61cm x 61cm
Format TILE
Thickness 2mm .08"



Altro Ollero™



Altro Ollero is a versatile, durable and eco-friendly rubber flooring solution designed to provide the look of more traditional commercial surfaces such as carpet, stone and even cork. Available in a range of 22 colors with a mixture of solid, speckled, neutral and vibrant tones, these tiles are guaranteed not to curl, harden or crack over time. Their integrated impact and sound absorption properties can help reduce fatigue and excess noise in high traffic areas.

With no need for additional finishes or wax, Altro Ollero is easy to clean and maintain without the use of harsh chemicals, making it a cost efficient option for retail, education and recreational areas. These precision water-jet cut tiles are easy to install and come in a square-edge glue-down format or an adhesive-free interlocking format with four different thickness options.

Typical applications

Retail, leisure, fitness centers, sporting arenas, education, childcare, gymnasiums, museums, libraries, amusement centers

Features + benefits

- Easy-to-clean
- Reduces fatigue
- Impact and sound absorbing
- High SCoF values wet or dry
- Long life expectancy + 10-year warranty
- Guaranteed not to curl
- High traction and durability



Looks great with

- Altro Lavencia
- Altro Reliance 25
- Altro Serenade
- Altro Wood Acoustic
- all Altro wall cladding options



Sustainability

- Up to 90% post-consumer recycled content
- Phthalate-free
- FloorScore certified and low VOC compliant
- Contributes to LEED

[More content online www.altro.com](http://www.altro.com)



Samples

Experience has shown that printing cannot reproduce colors accurately. If color choice is critical, please request a sample of the material.

Samples are available on altro.com or through Material Bank.



Piazza
10

Square - 4 / 8 / 10 / 12mm
Interlocking - 8 / 10 / 12mm



Arctic
02

Square - 4 / 8 / 10 / 12mm
Interlocking - 8 / 10 / 12mm

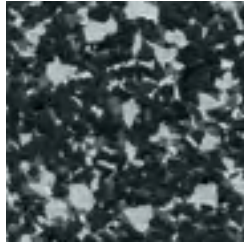

Mineral
19

Square - 4 / 8 / 10 / 12mm
Interlocking - 8 / 10 / 12mm

Featured in image left



Ebony
01

Square - 4 / 8 / 10 / 12mm
Interlocking - 8 / 10 / 12mm



Adobe
20

Square - 4 / 8 / 10 / 12mm
Interlocking - 8 / 10 / 12mm



Canvas
04

Square - 4 / 8 / 10 / 12mm
Interlocking - 8 / 10 / 12mm

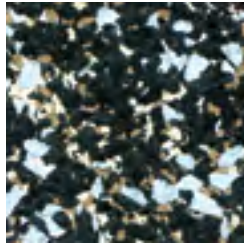

Lunar
12

Square - 4 / 8 / 10 / 12mm
Interlocking - 8 / 10 / 12mm

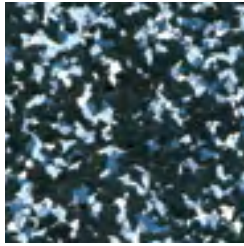

Zeal
22

Square - 4 / 8 / 10 / 12mm
Interlocking - 8 / 10 / 12mm



Zen
05

Square - 4 / 8 / 10 / 12mm
Interlocking - 8 / 10 / 12mm



Kiln
11

Square - 4 / 8 / 10 / 12mm
Interlocking - 8 / 10 / 12mm



Aqua
03

Square - 4 / 8 / 10 / 12mm
Interlocking - 8 / 10 / 12mm

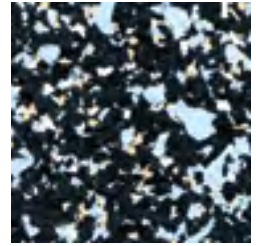

Tranquil
16

Square - 4 / 8 / 10 / 12mm
Interlocking - 8 / 10 / 12mm

Additional colors of Altro Ollero on reverse

Altro recommends carrying out a risk assessment to determine if you should install safety, slip-resistant or smooth flooring. Smooth flooring is not recommended in areas with prolonged contaminants present on floor.



Square tiles

38" x 38"

Glue-down installation



Interlocking tiles

37" x 37"

Adhesive-free installation



CERTIFIED BY
FSC Global Services

37" x 37"
38" x 38"
Format TILE
Thickness 4 / 8 / 10 / 12mm



Electra
18

Square - 4 / 8 / 10 / 12mm
Interlocking - 8 / 10 / 12mm

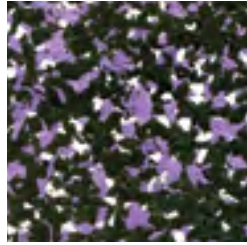

Aura
21

Square - 4 / 8 / 10 / 12mm
Interlocking - 8 / 10 / 12mm

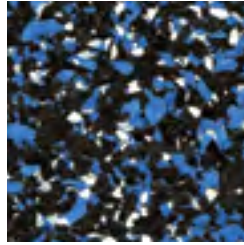

Wave
14

Square - 4 / 8 / 10 / 12mm
Interlocking - 8 / 10 / 12mm

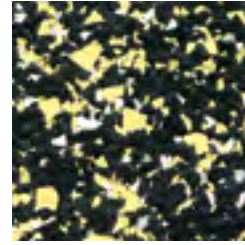

Astro
17

Square - 4 / 8 / 10 / 12mm
Interlocking - 8 / 10 / 12mm

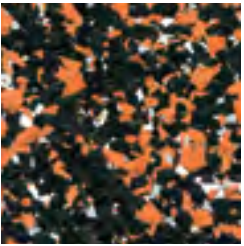

Pantile
15

Square - 4 / 8 / 10 / 12mm
Interlocking - 8 / 10 / 12mm

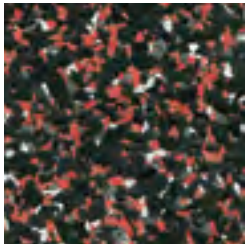

Flame
13

Square - 4 / 8 / 10 / 12mm
Interlocking - 8 / 10 / 12mm



Horizon
08

Square - 4 / 8 / 10 / 12mm
Interlocking - 8 / 10 / 12mm

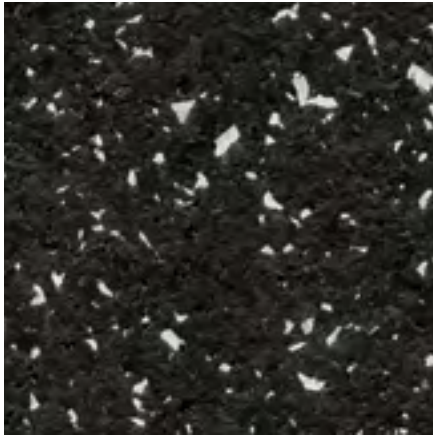

Ore
06

Square - 4 / 8 / 10 / 12mm
Interlocking - 8 / 10 / 12mm



Oasis
09

Square - 4 / 8 / 10 / 12mm
Interlocking - 8 / 10 / 12mm

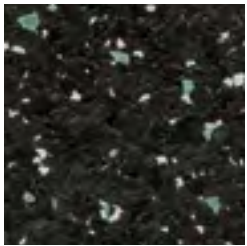

Serene
07

Square - 4 / 8 / 10 / 12mm
Interlocking - 8 / 10 / 12mm



Looks great with

- Altro Lavencia
- Altro Reliance 25
- Altro Serenade
- Altro Wood Acoustic
- all Altro wall cladding options



Sustainability

- Up to 90% post-consumer recycled content
- Phthalate-free
- FloorScore certified and low VOC compliant
- Contributes to LEED

[More content online www.altro.com](http://www.altro.com)



Samples

Experience has shown that printing cannot reproduce colors accurately. If color choice is critical, please request a sample of the material.

Samples are available on altro.com or through Material Bank.



Altro Dolce™ Tile



Altro Dolce tile combines the natural beauty of stone with the durability and resilience of enhanced vinyl. With its homogeneous pattern construction and a factory-finished PU coating, Altro Dolce will maintain its look throughout the life of the floor.

Altro Dolce is a sustainable flooring option containing 72% pre-consumer recycled content, helping construction projects achieve LEED certification. Installing Altro Dolce in front-of-house areas and Altro safety flooring in heavy duty/back-of-house areas is a very practical decision.

Typical applications

Schools, hallways, classrooms, cafeterias, lobbies, waiting rooms, retail, supermarkets, cafes, office buildings, general circulation areas



Looks great with

- Altro Lavencia LVT
- Altro Walkway 20
- Altro Operetta
- cladding options



Sustainability

- 72% pre-consumer recycled content
- Phthalate-free
- Contains bio-based content
- Low VOC compliant
- Contributes to LEED

More content online www.altro.com



Samples

Experience has shown that printing cannot reproduce colors accurately. If color choice is critical, please request a sample of the material.

Samples are available on altro.com or through Material Bank.

Features + benefits

- Homogeneous construction, pattern appears throughout thickness of product
- Balanced color palette with soft marbled looks
- Factory-finished PU coating for easy cleaning and maintenance
- Contains 72% pre-consumer recycled content
- Phthalate-free
- Contains bio-based content
- Tested to withstand 2500 psi
- Low VOCs



Heilo
AD1101 LRV 70

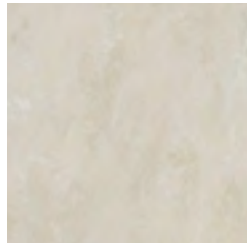

Taza
AD1113 LRV 59

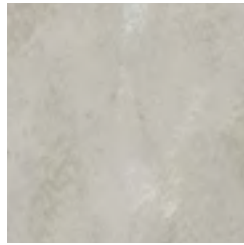

Castillo
AD1105 LRV 48

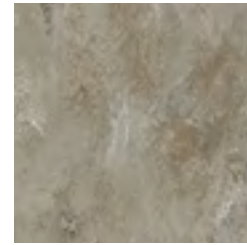

Lobo
AD1110 LRV 27

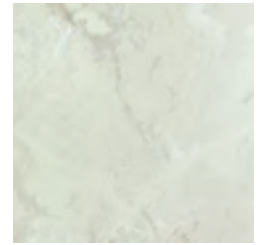

Piedra
AD502 LRV 52



Dia
AD501 LRV 68



Cemento
AD503 LRV 28

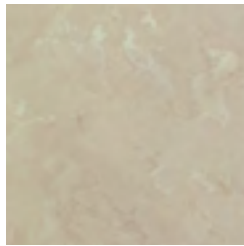

Madrid
AD505 LRV 51

Featured in image left

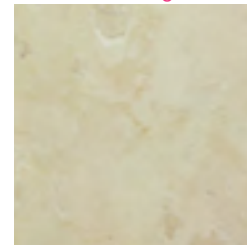

Marmol
AD507 LRV 52

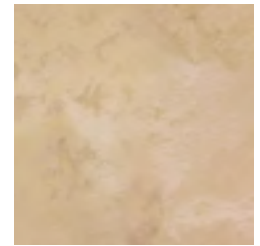

Barcelona
AD508 LRV 56

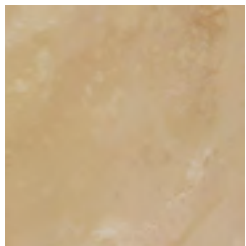

Playa
AD526 LRV 60

Featured in image left

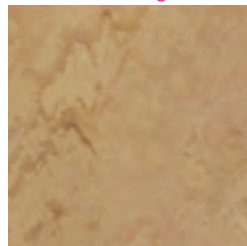

Tierra
AD514 LRV 36

Featured in image left

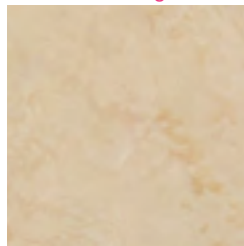

Pastel
AD527 LRV 57

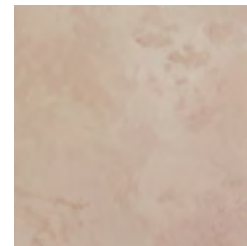

Granito
AD509 LRV 49

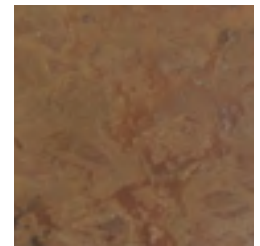

Tabaco
AD515 LRV 19

Additional colors of Altro Dolce on reverse

Altro recommends carrying out a risk assessment to determine if you should install safety, slip-resistant or smooth flooring. Smooth flooring is not recommended in areas with prolonged contaminants present on floor.

	18" x 18" 45.7cm x 45.7cm
	Format TILE
	Thickness 3mm .12"

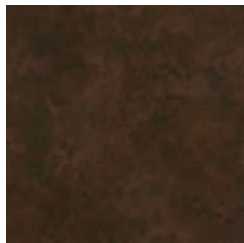

Murciélago
AD915 LRV 6

Featured in image right



Cielo
AD532 LRV 59

Featured in image right

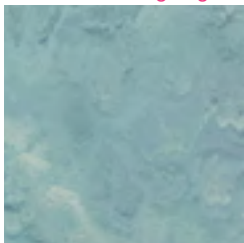

Agua
AD523 LRV 35



Oceano
AD609 LRV 30

Featured in image right

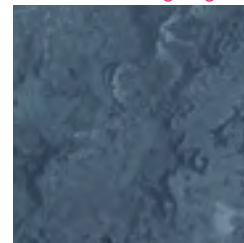

Rio
AD524 LRV 15



Lima
AD939 LRV 43

Featured in image right

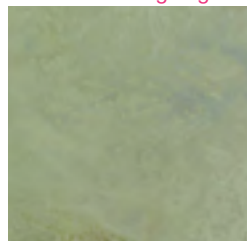

Cilantro
AD605 LRV 38

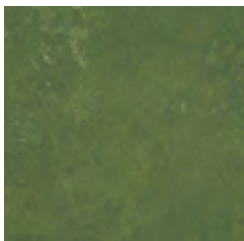

Árbol
AD941 LRV 12



Plátano
AD933 LRV 52



Marisposa
AD934 LRV 43



Ladrillo
AD511 LRV 19



Picante
AD950 LRV 18

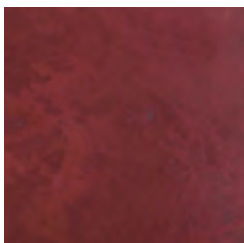

Sangría
AD611 LRV 13

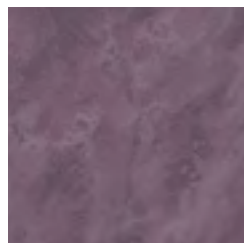

Lavanda
AD952 LRV 10

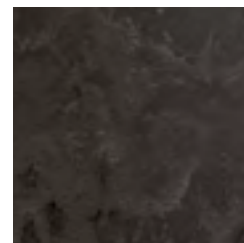

Noche
AD504 LRV 10



Looks great with

- Altro Lavencia LVT
- Altro Walkway 20
- Altro Operetta
- all Altro wall cladding options



Sustainability

- 72% pre-consumer recycled content
- Phthalate-free
- Contains bio-based content
- Low VOC compliant
- Contributes to LEED

[More content online www.altro.com](http://www.altro.com)



Samples

Experience has shown that printing cannot reproduce colors accurately. If color choice is critical, please request a sample of the material.

Samples are available on altro.com or through Material Bank.



	Altro Symphonia	Altro Operetta	Altro Orchestra	Altro Serenade	Altro Wood
Format	roll	roll	roll	roll	roll
Thickness	2mm .08"	2mm .08"	2.85mm .11"	3.9mm .15"	2mm .08"
Width	2m 6'7"	2m 6'7"	2m 6'7"	2m 6'7"	2m 6'7"
Length	20m 65'5"	20m 65'5"	20m 65'5"	20m 65'5"	20m 65'5"
Weight	4.6 lbs /yd ²	4.9lbs /yd ²	4.79 lbs /yd ²	5.34 lbs /yd ²	4.9 lbs /yd ²
Warranty	10 years	10 years	10 years	10 years	10 years
Slip resistance					
Dynamic Coefficient of Friction	.38 DCoF	.49 DCoF	.49 DCoF	.49 DCoF	.49 DCoF
ASTM D2047 dry / wet	.8 / .9	.7 / .8	.7 / .8	.7 / .8	.79 / .94
DIN 51130	R10	R10	R10	R10	R10
Sound insulation					
ISO 10140	5dB	4dB	15dB	19dB	4dB
IIC rating				54	
Test results					
Static load limit ASTM F970	2000psi	2000psi	1000psi	500psi	2500psi
Surface burning CAN/ULC - S102.2	tested	tested	tested	tested	tested
Critical radiant flux ASTM E648	Class 1	Class 1	Class 1	Class 1	Class 1
Smoke generation	pass	pass	pass	pass	pass
Cleaning technology					
Altro Easyclean	✓	✓	✓	✓	✓
PU / PUR					
Sustainable attributes					
Recycled content %	0/5	0/0	0/0	0/0	0/0
O-phthalate-free	✓	✓	✓	✓	✓
Low VOC	✓	✓	✓	✓	✓
FloorScore certified	✓	✓	✓	✓	✓
Bio-based content	✓	✓	✓	✓	✓

Altro Wood Comfort	Altro Wood Acoustic	Altro Lavencia LVT	Altro Quartz Tile	Altro Ollero	Altro Dolce
roll	roll	plank/tile	tile	tile	tile
2.85mm .11"	3.9mm .15"	3mm .12"	2mm .08"	4 / 8 / 10 / 12mm	3mm .12"
2m 6'7"	2m 6'7"	varies	24" 61cm	varies	18" 45.7cm
20m 65'5"	20m 65'5"	varies	24" 61cm	varies	18" 45.7cm
4.79 lbs /yd ²	5.34 lbs /yd ²	varies	53 lbs/carton	varies	44.35 lbs/carton
10 years	10 years	20 years	15 years	10 years	10 years
.49 DCoF	.49 DCoF	.22 DCoF	.27 DCoF		.59 DCoF
.79 / .94	.79 / .94	.6	> .6	.85 / 1.01	> .6
R10	R10				
15dB	19dB				
	54			4mm 57 8,10, 12mm 59	
1000psi	500psi	2000psi	3000psi	1000psi	2500psi
tested	tested	tested	tested	tested	tested
Class 1	Class 1	Class 1	Class 1	Class 1	Class 1
pass	pass	pass	pass	pass	pass
✓	✓				
		✓	✓	✓	✓
0/0	0/0	0/0	0/0	0/<90	72/0
✓	✓	✓	✓	✓	✓
✓	✓	✓	✓	✓	✓
✓	✓	✓		✓	
✓	✓		✓		✓



Hull Hospital chose a suite of Altro floor and wall products for its new birthing facility including digitally printed walls, Altro Whiterock and AW wall designs.

wall systems

Choosing your wall system solution is simple; it's all about where you need to use it. Will it be a functional, hygienic, watertight installation? Are you looking to protect against scuffs and scratches? Or are aesthetics more important? We have wall systems that suit all of these credentials and more, including digitally printed wall panels to create interiors that are truly spectacular and can be customized to suit your specific design goals.

Wall systems

Why choose walls from Altro?	110
Our wall portfolio	111
Wall products	112
Integrated floor + wall solutions	114
Technical chart	134

Why choose walls from Altro?

Our wall systems were introduced over 35 years ago and have been a market leader ever since. Providing creative freedom to designers, specifiers and end users, our effective, impervious walls systems deliver a safe, hygienic, decorative and fire-compliant wall solution.

Our portfolio includes functional, performance-driven wall protection as well as more decorative options. With a wide range of solutions, we can provide you with complete design flexibility for any environment.



A complete system

What makes us different from our competition? Our system! We don't just supply wall panels - we supply the whole system including accessories, adhesives, tools, installer training classes and the support staff to back them all up.

With multiple methods of joining panels and transitioning from floor to wall, Altro has a wall solution for every application area.

Typical wall system applications

- Shower enclosures and wet areas
- Operating rooms and sterile areas
- Cleanrooms and laboratories
- Commercial kitchens and back-of-house
- Manufacturing and production
- High-traffic areas
- Receptions, lobbies and front-of-house
- Retail and corporate
- Wainscoting, backsplashes and headboards

Functional wall products



Altro Whiterock White



Altro Whiterock Satins

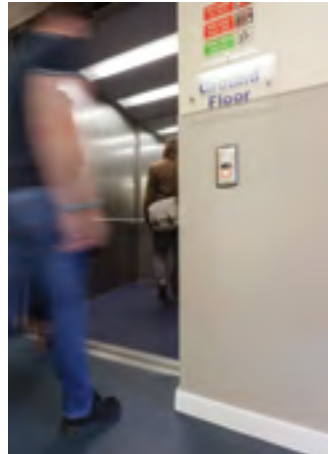

Altro Whiterock Matte

Wall protection



Altro Puraguard

Decorative wall products



Altro Whiterock Chameleon



Altro Whiterock wall designs



Altro Whiterock PopArt



Altro Whiterock Digiclad



AW Imagination Wall



AW Whiteboard

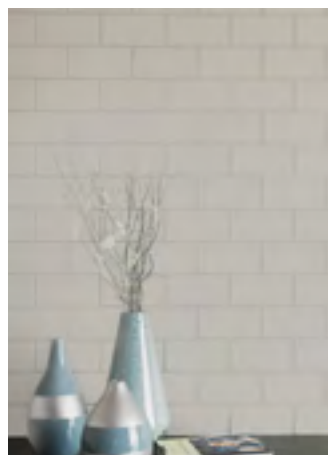

Altro Tegulis

Altro Whiterock™

White and Satins

Villa Laureana



Altro Whiterock provides continuously smooth, impact-resistant wall protection without gaps or grout. It is ideally suited for areas in which hygiene and cleanability are critical, as well as those that require a water-resistant finish.

Designed to integrate with Altro flooring using a seamless, watertight joint, Altro Whiterock panels are capable of being heat formed and bent around corners, pipes and other extrusions. This eliminates the threat of bacteria hiding in accessories, cracks, gaps and inadequate seam treatments that are common with other wall products.

This versatile wall protection provides unmatched durability that can help reduce maintenance costs, avoiding common repairs associated with tile, drywall and paint alternatives.

Typical applications

Wet areas, operating rooms, pharmaceuticals, cleanrooms, sterile areas, manufacturing and production facilities



Looks great with

- Safety flooring
- Slip-resistant flooring
- Adhesive-free flooring
- Smooth flooring



Sustainability

- Phthalate-free
- Emits no VOCs
- Contributes to LEED
- EPD available

More content online www.altro.com



Samples

Experience has shown that printing cannot reproduce colors accurately. If color choice is critical, please request a sample of the material.

Samples are available on altro.com or through Material Bank.

Features + benefits

- Impact-resistant
- Prevents water ingress to substrate
- Heat-weldable and thermoformable on site
- Easy-to-clean, low maintenance costs
- Extremely hygienic
- Emits no VOCs
- Class A fire-rated, CAN/ULC tested
- HACCP approved
- Meets ISO Class 2
- Create an integrated floor and wall solution
- Color matched accessories and trims
- Product specific EPD available



Standard White
8' / 2.5m W103
10' / 3.0m W104

LRV 89



Linen
8' / 2.5m W136/41
10' / 3.0m W137/41

LRV 83

Featured in image left

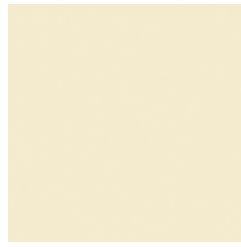

Oyster
8' / 2.5m W136/32
10' / 3.0m W137/32

LRV 70



Fawn
8' / 2.5m W136/206
10' / 3.0m W137/206

LRV 41

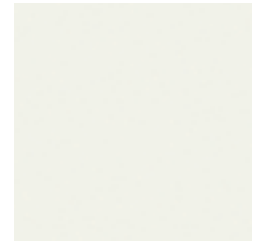

Cesco
8' / 2.5m W136/53
10' / 3.0m W137/53

LRV 71

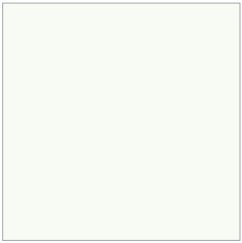

Ice
8' / 2.5m W136/44
10' / 3.0m W137/44

LRV 80

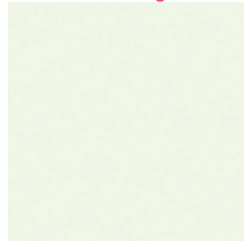

Seafoam
8' / 2.5m W136/43
10' / 3.0m W137/43

LRV 81

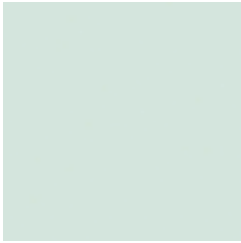

Mint
8' / 2.5m W136/203
10' / 3.0m W137/203

LRV 62

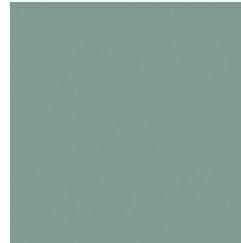

Promenade
8' / 2.5m W136/212
10' / 3.0m W137/212

LRV 32



Olea
8' / 2.5m W136/218
10' / 3.0m W137/218

LRV 28

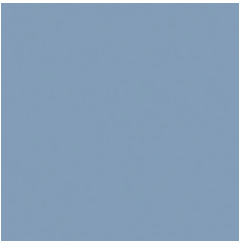

Flint
8' / 2.5m W136/201
10' / 3.0m W137/201

LRV 32



Vibrance
8' / 2.5m W136/213
10' / 3.0m W137/213

LRV 22



Viola
8' / 2.5m W136/214
10' / 3.0m W137/214

LRV 13



Echo
8' / 2.5m W136/208
10' / 3.0m W137/208

LRV 43



Urban
8' / 2.5m W136/210
10' / 3.0m W137/210

LRV 28



Bergamot
8' / 2.5m W136/220
10' / 3.0m W137/220

LRV 26



Scarlett
8' / 2.5m W136/221
10' / 3.0m W137/221

LRV 13



LRV = Light reflectance value

Please keep LRVs in mind when selecting walls for areas with dementia and Alzheimer's patients, seniors or individuals with poor vision.



Color matched weldrods, sanitary sealants and accessories are available.



Altro Whiterock White and Altro Whiterock Satins are different prices. Satins refers to all colors except Standard White.



4' x 8'2" (2.5m)
4' x 9'10" (3m)

Format
PANEL

Thickness
2.5mm | .10"

An integrated floor and wall solution

Altro Whiterock is an integrated solution, meaning it fits together perfectly to provide a hygienic, watertight surface that's ideal for designing a sterile field. This doesn't just offer the best possible protection against bacteria and contamination; it makes cleaning easy too.

Easy-to-clean

Effective detailing + accessories

Fully sealed

Thermoformed on-site

Heat-welded joints

High impact resistance

Easy to keep clean

Together, our products provide a robust, hard-wearing surface that resists stains, odors and chemicals. PVC is non-porous, non-shedding, and has very high impact resistance, preventing damage that can trap bacteria compared to traditional surfaces.

Fully sealed

Altro Whiterock is a fully-bonded system with hygienic sealed edges, abutments and joints. It can even be sealed around fixtures and fittings.

When joined together with Altro flooring, our wall panels form a watertight covering - from floor to ceiling.

Thermoforming

Because our wall panels can be molded around corners on-site, they form an uninterrupted surface that's resistant to impact and damage. There's no need for unsightly corner trims which can form potential dirt traps that are difficult to access and clean.

Joint forces

Joints and junctions are a key part of system integrity. For instance, did you know that traditional flooring cap trims used with resilient flooring forms a ledge that is not USP 797/800 compliant?

While we have multiple joining methods, we recommend heat welding for all wall joints and overlapping for wall-to-floor transitions in hygienic areas.

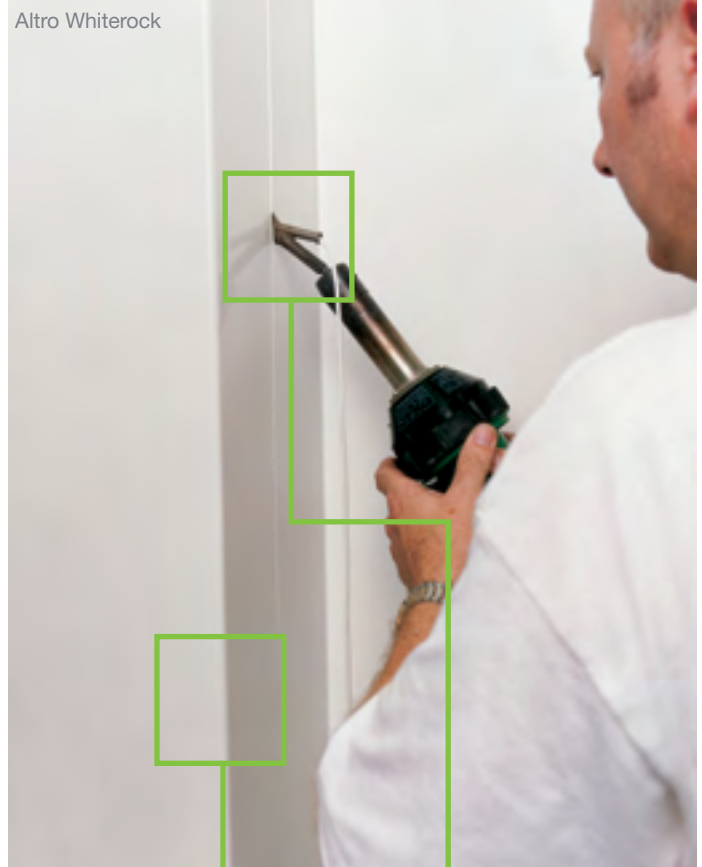

Altro Whiterock

Thermoformed corners
No unsightly trims

Heat-welded joints
Fully-sealed, seamless joining



Cross section of wall cladding overlapping floors

Cove stick
For a smooth transition
up the wall

Wall overlaps floor
Typical installation



Rockville General Hospital's behavioral and mental health ward chose Altro Whiterock, Altro Aquarius and Altro Walkway 20

Altro Whiterock™ Matte

Bro Teffi School



Doors and plaster board walls can easily be damaged, whether by scrapes and knocks as people pass, or more serious dents and holes caused by wheeled traffic. Altro Whiterock Matte has been specifically designed to protect these surfaces. Altro Whiterock Matte is dense, impervious and resistant to bumps. It features a lightly-textured surface and homogeneous color which camouflages scuffs and scratches, keeping the wall area looking better longer.

With an impervious, easy-to-wipe surface, Altro Whiterock Matte improves cleanability, which is a major advantage within its recommended application areas.

Typical applications

High-traffic areas, corridors, food manufacturing, back-of-house, showers and spas



Looks great with

- Safety flooring
- Slip-resistant flooring
- Adhesive-free flooring
- Smooth flooring



Sustainability

- Phthalate-free
- Emits no VOCs
- Contributes to LEED
- EPD available

More content online www.altro.com



Samples

Experience has shown that printing cannot reproduce colors accurately. If color choice is critical, please request a sample of the material.

Samples are available on altro.com or through Material Bank.

Features + benefits

- Impact-resistant
- Lightly textured, matte finish camouflages superficial scuffs and scratches
- Prevents water ingress to substrate
- Heat-weldable and thermoformable on site
- Easy-to-clean, low maintenance costs
- Extremely hygienic
- Emits no VOCs
- Class A fire-rated, CAN/ULC tested
- Create an integrated floor and wall solution
- Color matched accessories and trims
- Product specific EPD available



Featured in image above

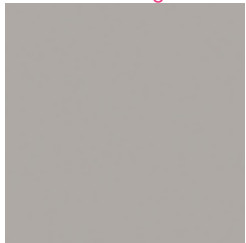

Battleship
10' / 3.0m W151/FT208

LRV 43

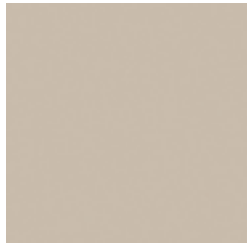

Tan
10' / 3.0m W151/FT206

LRV 41

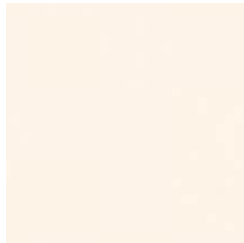

Almond
10' / 3.0m W151/FT32

LRV 70

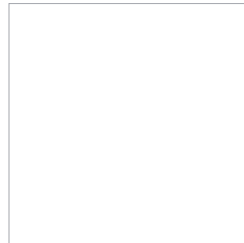

Pearl
10' / 3.0m W151/FT41

LRV 83



Denim
10' / 3.0m W151/FT201

LRV 32



LRV = Light reflectance value

Please keep LRVs in mind when selecting walls for areas with dementia and Alzheimer's patients, seniors or individuals with poor vision.



Color matched weldrods, sanitary sealants and accessories are available.



Our wall portfolio varies greatly in pricing from product to product. Please ask your local sales representative for accurate pricing.



4' x 9'10" (3m)
Format PANEL
Thickness 2.5mm .10"

Altro Whiterock Chameleon

SKT Hospital



Make a bold statement with Altro Whiterock Chameleon – the glossy, vibrant and vividly colorful wall cladding. Altro Whiterock Chameleon is available in 13 high-impact, high-design shades to add a little bit of affordable luxury to a range of environments.

Offering all the benefits of Altro Whiterock, Altro Whiterock Chameleon is durable with a smooth, watertight, wipe-clean surface.

Typical applications

High-end bathrooms, showers and changing areas, reception, lobbies, serveries, retail, backsplashes



Looks great with

- Safety flooring
- Slip-resistant flooring
- Adhesive-free flooring
- Smooth flooring



Sustainability

- Phthalate-free
- Emits no VOCs
- Contributes to LEED

More content online www.altro.com



Samples

Experience has shown that printing cannot reproduce colors accurately. If color choice is critical, please request a sample of the material.

Samples are available on altro.com or through Material Bank.

Features + benefits

- Glossy, vibrant looks
- Create striking aesthetic appeal
- Impact-resistant
- Prevents water ingress to substrate
- Heat-weldable and thermoformable on site
- Easy-to-clean, low maintenance costs
- Extremely hygienic
- Class A fire-rated, CAN/ULC tested
- Emits no VOCs
- Create an integrated floor and wall solution
- Color matched accessories and trims

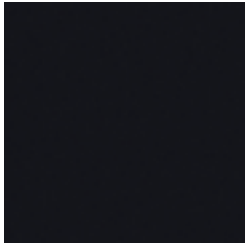

Liquorice
8' / 2.5m W160/6612
10' / 3.0m W161/6612

LRV 5



Distant Thunder
8' / 2.5m W160/6634
10' / 3.0m W161/6634

LRV 18



Pure Innocence
8' / 2.5m W160/6601
10' / 3.0m W161/6601

LRV 92



Eau De Chic
8' / 2.5m W160/6605
10' / 3.0m W161/6605

LRV 48

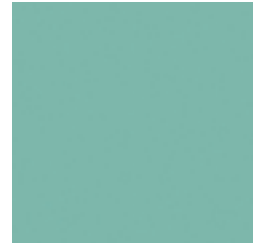

Sheer Glass
8' / 2.5m W160/6609
10' / 3.0m W161/6609

LRV 40



Nightfall
8' / 2.5m W160/6622
10' / 3.0m W161/6622

LRV 15



Slip Stream
8' / 2.5m W160/6611
10' / 3.0m W161/6611

LRV 36



Hawaiian Palm
8' / 2.5m W160/6638
10' / 3.0m W161/6638

LRV 22



Taxi Cab
8' / 2.5m W160/6636
10' / 3.0m W161/6636

LRV 58



Juicy Lucy
8' / 2.5m W160/6620
10' / 3.0m W161/6620

LRV 20



Moulin Rouge
8' / 2.5m W160/6618
10' / 3.0m W161/6618

LRV 12



Feng Shui
8' / 2.5m W160/6617
10' / 3.0m W161/6617

LRV 9

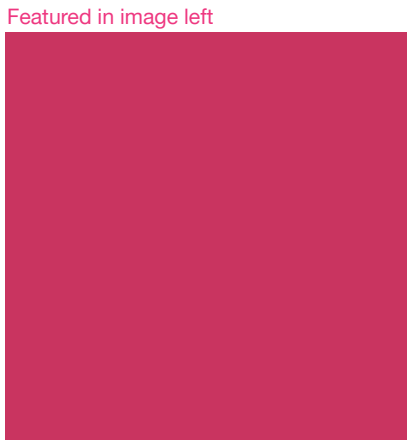

Featured in image left

Shocking Pink
8' / 2.5m W160/6616
10' / 3.0m W161/6616

LRV 15



LRV = Light reflectance value

Please keep LRVs in mind when selecting walls for areas with dementia and Alzheimer's patients, seniors or individuals with poor vision.



Color matched weldrods, sanitary sealants and accessories are available.



Our wall portfolio varies greatly in pricing from product to product. Please ask your local sales representative for accurate pricing.



4' x 8'2" (2.5m)
4' x 9'10" (3m)

Format
PANEL

Thickness
2.5mm | .10"

Altro Whiterock™ wall designs

UNC EDTU



Altro Whiterock wall designs combine the durability, hygiene and resilience of Altro Whiterock wall panels with striking patterns sure to enhance today's contemporary, commercial interiors.

The attractive palette of wood, linen, concrete and metallic visuals ensure these decorative wall panels will shine in even in the most inspirational front-of-house settings.

Altro Whiterock wall designs coordinate exceptionally well with our flooring, providing designers, specifiers and end users an extensive suite of creative options all under the Altro name.

Typical applications

Front-of-house, healthcare, senior living, hospitality, education, lobbies, reception, leisure, headboards, backsplashes



Looks great with

- Safety flooring
- Slip-resistant flooring
- Adhesive-free flooring
- Smooth flooring



Sustainability

- Phthalate-free
- Emits no VOCs
- Contributes to LEED

More content online www.altro.com



Samples

Experience has shown that printing cannot reproduce colors accurately. If color choice is critical, please request a sample of the material.

Samples are available on altro.com or through Material Bank.

Features + benefits

- Modern pattern looks
- Create striking aesthetic appeal
- Impact-resistant
- Prevents water ingress to substrate
- Heat-weldable and thermoformable on site
- Easy-to-clean, low maintenance costs
- Extremely hygienic
- Emits no VOCs
- Class A fire-rated, CAN/ULC tested
- Create an integrated floor and wall solution
- Contrasting accessories and trims

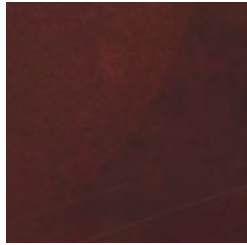

Antique Copper
8' / 2.5m WDS25/9912
10' / 3.0m WDS30/9912

LRV 10



Winter Weave
8' / 2.5m WDS25/9909
10' / 3.0m WDS30/9909

LRV 58



Autumn Weave
8' / 2.5m WDS25/9910
10' / 3.0m WDS30/9910

LRV 43

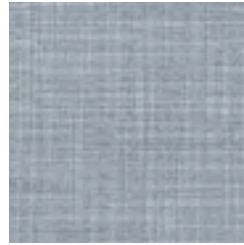

Summer Weave
8' / 2.5m WDS25/9908
10' / 3.0m WDS30/9908

LRV 36

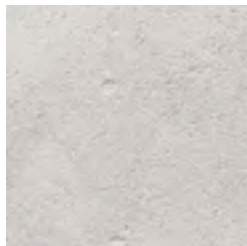

White Mineral
8' / 2.5m WDS25/9905
10' / 3.0m WDS30/9905

LRV 61

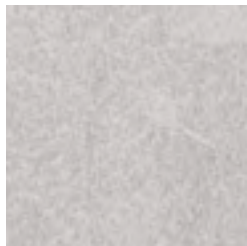

Cool Mineral
8' / 2.5m WDS25/9906
10' / 3.0m WDS30/9906

LRV 48



Urban Mineral
8' / 2.5m WDS25/9907
10' / 3.0m WDS30/9907

LRV 28

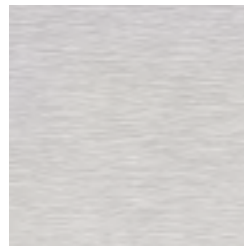

Brushed Steel
8' / 2.5m WDS25/9911
10' / 3.0m WDS30/9911

LRV 54

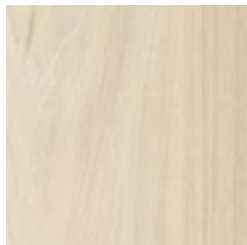

Soft Woodgrain
8' / 2.5m WDS25/9901
10' / 3.0m WDS30/9901

LRV 52

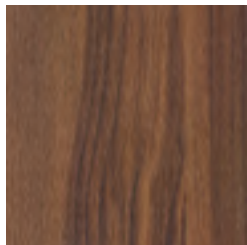

Rich Woodgrain
8' / 2.5m WDS25/9902
10' / 3.0m WDS30/9902

LRV 14

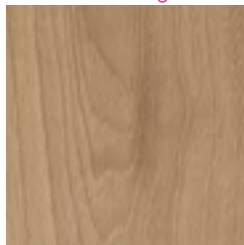

Warm Woodgrain
8' / 2.5m WDS25/9904
10' / 3.0m WDS30/9904

LRV 38

Featured in image left

For product information and inspirational imagery please read our brochure or visit altro.com



LRV = Light reflectance value

Please keep LRVs in mind when selecting walls for areas with dementia and Alzheimer's patients, seniors or individuals with poor vision.



Color matched weldrods, sanitary sealants and coordinating trims are available.



Our wall portfolio varies greatly in pricing from product to product. Please ask your local sales representative for accurate pricing.



4' x 8'2" (2.5m)
4' x 9'10" (3m)

Format
PANEL

Thickness
2.5mm | .10"

Altro Whiterock™ PopArt



Altro Whiterock PopArt allows you to reproduce custom images and artwork onto Altro Whiterock wall panels to create durable, vibrant design options for a variety of applications.

Available as a completely custom product, print with your own imagery or choose from a wide variety of preselected standard imagery that can easily adapt to your design's specific needs. From scenic landscapes and inspirational architecture to intricate geometric patterns, we have multiple looks that can help make a bold impact, impress clientele or even create calm, soothing settings for patients.

Altro Whiterock PopArt is manufactured in North America with a six-week lead time.

Typical applications

Healthcare, senior living, pediatrics, education, athletics, hospitality, lobbies and reception, corporate and offices, leisure, general areas



Looks great with

- Safety flooring
- Slip-resistant flooring
- Adhesive-free flooring
- Smooth flooring



Sustainability

- Phthalate-free
- Emits no VOCs
- Contributes to LEED

More content online www.altro.com



Samples

Experience has shown that printing cannot reproduce colors accurately. If color choice is critical, please request a sample of the material.

Samples are available on altro.com

Choose your format

Altro Whiterock PopArt is available in three different formats, including two protective film options that can adapt to your design's specific needs.

- **Lite** - no protective film and is best used in low-traffic areas that do not require the use of disinfectants, 1-year warranty
- **Matte** - a protective matte film that resists common scuffs and scratches, 5-year warranty
- **Gloss+** - a graffiti and chemical-resistant, dry-erase film that offers a high level of surface protection, 10-year warranty, and coordinating accessories and trims

Altro Whiterock PopArt Lite

Your image is digitally printed onto Altro Whiterock™ without the use of any optional protective films, suitable for low-traffic areas where damage to the panel is unlikely.



Altro Whiterock PopArt Matte

After printing, a protective matte finish film is applied over the surface of the printed Altro Whiterock™ panel.



Altro Whiterock PopArt Gloss+

Our damage-resistant option - after printing, a high-gloss graffiti-resistant dry-erase film is applied over the panel.

Your printed panels are also now usable as a writeable whiteboard surface.



For full product details, information and our standard image collection please read our brochure or visit altro.com



warranty varies

4' x 8'2" (2.5m)
4' x 9'10" (3m)

Format
PANEL

Thickness
2.5mm | .10"



Altro Whiterock™ Digiclad



UCH London

Similar to our Altro Whiterock PopArt product, Altro Whiterock Digiclad allows you to create the right impression with a custom design on your wall. From a calming coastal landscape in a hospital ward to a bold company logo in a reception area, the only limit is your imagination.

Altro Whiterock Digiclad is created by reproducing vector artwork (or an extremely high-resolution photograph) onto Altro Whiterock wall panels. Hard-coat technology provides scratch-resistant properties for added surface protection.

Altro Whiterock Digiclad utilizes the same standard image gallery as Altro Whiterock PopArt. It has a 14-week lead time and ships from the UK. Altro Whiterock PopArt is manufactured in North America with a 6-week lead time.

Typical applications

Healthcare, senior living, pediatrics, education, athletics, hospitality, lobbies and reception, corporate and offices, leisure, general areas



Looks great with

- Safety flooring
- Slip-resistant flooring
- Adhesive-free flooring
- Smooth flooring



Sustainability

- Phthalate-free
- Emits no VOCs
- Contributes to LEED

More content online www.altro.com



Samples

Experience has shown that printing cannot reproduce colors accurately. If color choice is critical, please request a sample of the material.

Samples are available on altro.com

Features + benefits

- Liquid hard-coat protects image from scuffs
- Create striking aesthetic appeal
- Provide your own imagery or select from our standard image gallery
- Prevents water ingress to substrate
- Heat-weldable and thermoformable on site
- Easy-to-clean, low maintenance costs
- Extremely hygienic
- Emits no VOCs
- Class A fire-rated, CAN/ULC tested
- Create an integrated floor and wall solution
- Coordinating accessories and trims including printed joint strips

Altro Whiterock Digiclad

After printing, a protective liquid hard-coat is applied over the surface of the printed Altro Whiterock™ panel. Curing time and freight from the UK make for a longer overall production time.

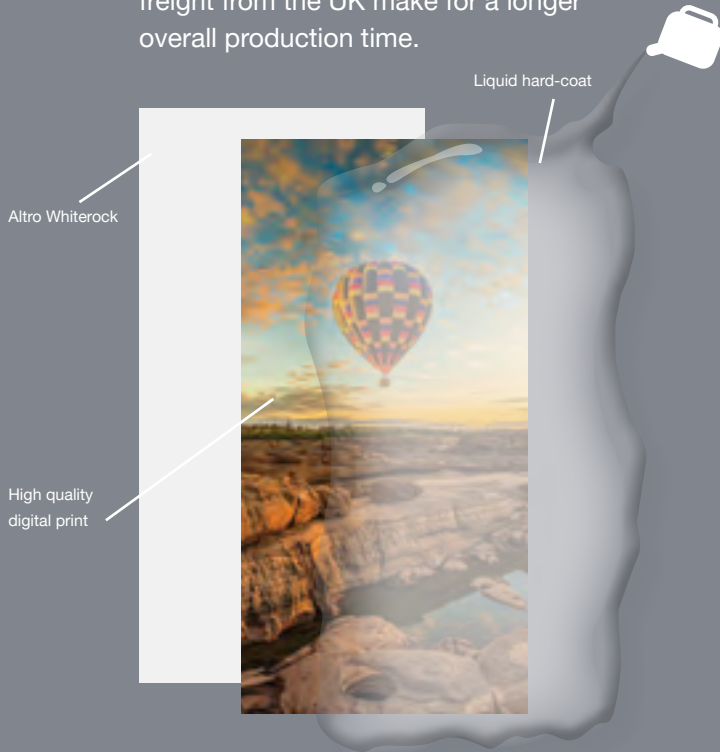

For full product details, information and our standard image collection please read our brochure or visit altro.com

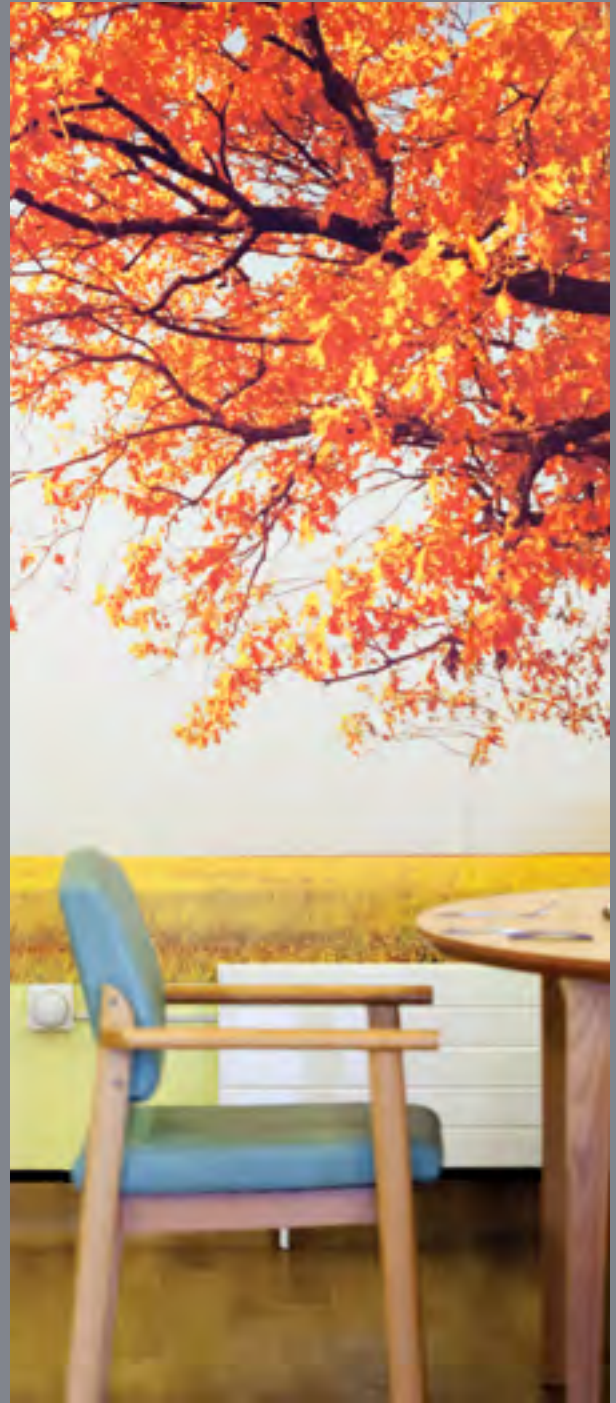

Gossoms End Hospital



4' x 8'2" (2.5m)
4' x 9'10" (3m)

Format
PANEL



Thickness
2.5mm | .10"

Altro Whiterock™ Imagination Wall



Altro Whiterock Imagination Wall combines customizable print options with a versatile dry-erase finish. Available in six imaginative scenes, these wall panels provide children with a low-maintenance creative outlet while simultaneously protecting walls from scuffs and dings commonly found in pediatric offices and classrooms.

Typical applications

Doctor's offices, classrooms, hospitals, activity centers, waiting rooms, childcare

Features + benefits

- Standard scenes in 4' x 3' size
- Custom sizing up to 4' x 8'2" and 4' x 9'10"
- Use our standard image gallery (shown right) or supply your own for complete control
- Durable wall panels
- Dry-erase finish
- Graffiti-resistant
- Six-week lead time
- Class A fire-rated, CAN/ULC tested
- Manufactured in North America
- Same surface technology as Altro Whiterock PopArt Gloss+



Looks great with

- Safety flooring
- Slip-resistant flooring
- Adhesive-free flooring
- Smooth flooring



Sustainability

- Phthalate-free
- Emits no VOCs
- Contributes to LEED

More content online www.altro.com



Samples

Experience has shown that printing cannot reproduce colors accurately. If color choice is critical, please request a sample of the material.

Samples are available on altro.com

Featured in image left



Dinosaurs
Sizes up to 4' x 9'10"



Geometric shapes
Sizes up to 4' x 9'10"



Space
Sizes up to 4' x 9'10"



Planes
Sizes up to 4' x 9'10"



Pirates
Sizes up to 4' x 9'10"

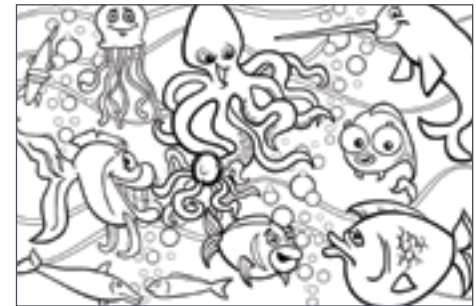

Under the sea
Sizes up to 4' x 9'10"

Panel sizing



A little too child-like? We've had many happy custom customers! Anything from nurse's station boards, to patient room charts, to corporate office needs! Just ask. We can help!



LRV = Light reflectance value

Please keep LRVs in mind when selecting walls for areas with dementia and Alzheimer's patients, seniors or individuals with poor vision.



Color matched weldrods, sanitary sealants and accessories are available.



Our wall portfolio varies greatly in pricing from product to product. Please ask your local sales representative for accurate pricing.



4' x 3' (.9m)
4' x 8'2" (2.5m)
4' x 9'10" (3m)
Format PANEL
Thickness 2.5mm .10"

Altro Whiterock™ Whiteboard



Altro Whiterock Whiteboard is a premium clear dry-erase coating that allows for any Altro wall panel to be turned into a custom dry-erase board.

The chemical and scratch-resistant clear gloss surface safeguards against ghosting and staining from ink as well as graffiti. When compared to other dry-erase boards, Altro Whiterock Whiteboard is remarkably easier to erase.

Its anti-graffiti properties also allow for easy removal of permanent marker with rubbing alcohol.

Typical applications

Operating rooms, nurses' stations, patient rooms, boardrooms, chef boards, education, daycare

Features + benefits

- Durable overlamine film - 2mil thick
- 10-year warranty
- No ghosting
- Graffiti-resistant
- Class A fire-rated, CAN/ULC tested
- Resists scratches, abrasion, water damage, and corrosion from solvents, stains, and chemicals
- Blends the durability and hygiene of Altro Whiterock with versatility of dry-erase
- Integrates with other Altro Whiterock panels allowing for designated areas to be dry-erase capable



Sustainability

- Phthalate-free
- Emits no VOCs
- Contributes to LEED

More content online www.altro.com



Samples

Experience has shown that printing cannot reproduce colors accurately. If color choice is critical, please request a sample of the material.

Samples are available on altro.com



4' x 8'2" (2.5m)
4' x 9'10" (3m)

Format
PANEL

Thickness
2.5mm | .10"



Altro Whiterock™ Recessed Shelf



To complement Altro Whiterock in shower areas, we are now offering prefabricated, factory-formed, recessed shelf units. Made from the exact same material as Altro Whiterock wall panels, these shower units are ideally suited for mental health installations. They are recessed into the drywall and heat-welded flush to the adjoining wall panel, making them an extremely hygienic, smooth solution and ideal for use in healthcare, senior living, and mental health facilities.

Seamed flush to the wall with no ledges or lips to grab hold of, the system is tamper-resistant and free from potential ligature points.

Typical applications

Showers in healthcare, senior living, behavioral health and leisure areas



All colors from Altro Whiterock Satins range are available as a custom order with MOQs and increased custom pricing.



Sustainability

- Phthalate-free
- Emits no VOCs
- Contributes to LEED

More content online www.altro.com

Features + benefits

- Integrates with Altro Whiterock panel
- Available in four colors that match Altro Whiterock - Standard White, Linen, Oyster and Fawn.
- Extremely hygienic
- Easy-to-clean
- Recessed into the wall
- Flush heat welding
- Tamper-resistant
- Free from ligature points



16" x 16" outside
10" x 10" inside

Format
INSERT

Thickness
2.3mm | .09"



Altro Tegulis™



For a sophisticated space, create your own style with ease. Altro Tegulis is an innovative wall solution available in an extensive color and design palette. With a chic look and feel of tile, the custom-etched grout lines offer a hygienic solution eliminating scrubbing and repair issues. This easy-to-install system is available in interlocking and straight-edge formats with a variety of tile sizes capable of adapting to different designs.

Unlike traditional porous grout used in ceramic tile installations, the grout lines embedded into Altro Tegulis' surface are impervious to moisture. Using our half lap installation method combined with our sanitary sealant, Altro Tegulis prevents water and bacteria from penetrating below the surface, allowing for thorough cleaning and disinfecting. This provides an authentic tiled visual, without any of the unhygienic drawbacks.

Features + benefits

- Extensive color + pattern palette
- Etched grout lines maintain hygiene
- Resists bacterial growth
- Non-porous, hydrophobic
- Class A fire-rated, CAN/ULC tested
- Emits no VOCs
- Lead-free, phthalate-free

Typical applications

Residential healthcare, multi-family residential, shower enclosures, tub rooms, bathrooms, backsplash, focal walls, kitchenettes



Looks great with

- Safety flooring
- Slip-resistant flooring
- Adhesive-free flooring
- Smooth flooring



Sustainability

- Phthalate-free
- Emits no VOCs
- Contributes to LEED

More content online www.altro.com



Samples

Experience has shown that printing cannot reproduce colors accurately. If color choice is critical, please request a sample of the material.

Samples are available on altro.com

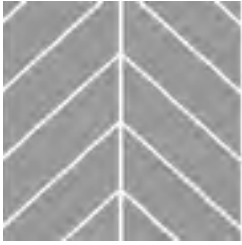

Chevron
2.9" x 5.325"

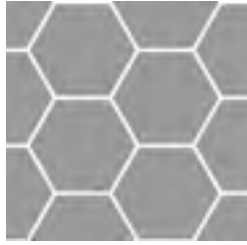

Hexagon
4.25" x 4.95"

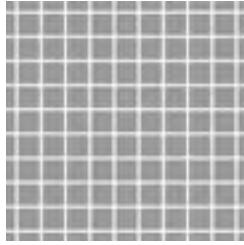

1" Mosaic
1" x 1"

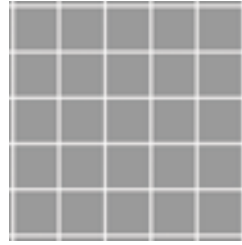

2" Mosaic
2" x 2"

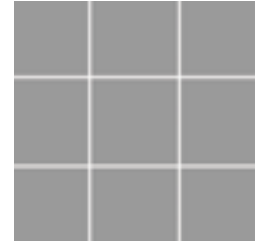

4" Square Tile
4" x 4"

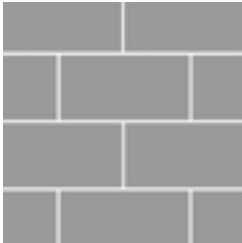

3" x 6" Subway Tile
3" x 6"

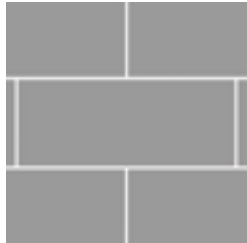

4" x 10" Subway Tile
4" x 10"

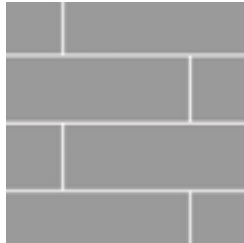

3" x 12" Subway Tile
3" x 12"

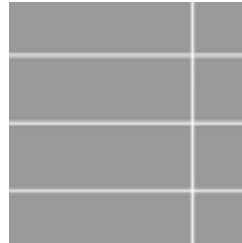

Stacked Tile
3" x 12"

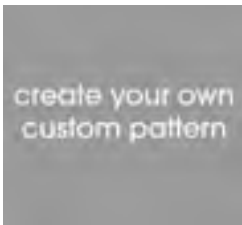

Create your own
Any size

Featured in image left



Herringbone
3" x 6" on the diagonal

For full product details and information please read our brochure or visit altro.com



LRV = Light reflectance value

Please keep LRVs in mind when selecting walls for areas with dementia and Alzheimer's patients, seniors or individuals with poor vision.



Color matched weldrods, sanitary sealants and accessories are available.



Our wall portfolio varies greatly in pricing from product to product. Please ask your local sales representative for accurate pricing.



*4' x 8'2" (2.5m)
*4' x 9'10" (3m)

Format
PANEL

Thickness
2.5mm | .10"

Altro Puraguard™



Create a complete floor and wall solution for back-of-house areas by combining Altro Puraguard wall panels and accessories with Altro safety flooring. The easy-maintenance, hygienic PVC surface will help you assure that your kitchen is clean and that food is safe for consumption. Better yet, Altro Puraguard has become the in-demand, economically priced wall protection product for back-of-house areas and is a great alternative to FRP.

Say goodbye to cracked tiles! Altro Puraguard is durable and can prevent damage to walls from moving carts, bumps and dings. Its homogeneous throughout coloring camouflages scuffs so your kitchen stays looking new longer.

Typical applications

Commercial kitchens, food prep, service areas, back-of-house areas, janitorial closets



Looks great with

- Safety flooring
- Slip-resistant flooring



Sustainability

- Phthalate-free
- Emits no VOCs
- Contributes to LEED
- EPD available

More content online www.altro.com



Samples

Experience has shown that printing cannot reproduce colors accurately. If color choice is critical, please request a sample of the material.

Samples are available on altro.com

Features + benefits

- High stain and chemical resistance
- Durable system accessories
- Fully bonded to substrate
- No glass fibers
- Impervious to water ingress
- Withstands robust cleaning procedures including pressure washing
- Resists mold and fungi growth
- Meets USDA, FDA and CFIA standards
- Class A fire-rated, CAN/ULC tested
- Non-porous, non-shedding
- Product specific EPD available



Featured in image left



Salt
9' / 2.75m W139
10' / 3.0m W135

LRV 89



Barley
9' / 2.75m W140/300
10' / 3.0m W141/300

LRV 50

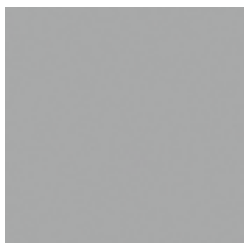

Pepper
9' / 2.75m W140/301
10' / 3.0m W140/301

LRV 40

For full product details and information please read our brochure or visit altro.com/puraguard

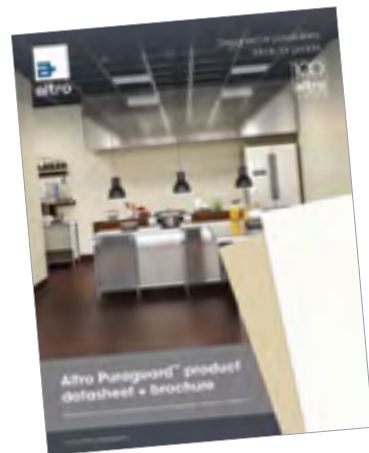

LRV = Light reflectance value

Please keep LRVs in mind when selecting walls for areas with dementia and Alzheimer's patients, seniors or individuals with poor vision.



Color matched weldrods, sanitary sealants and accessories are available.



Our wall portfolio varies greatly in pricing from product to product. Please ask your local sales representative for accurate pricing.



4' x 9' (2.75m)
4' x 10' (3m)

Format
PANEL

Thickness
2mm | .08"

	Altro Whiterock	Altro Whiterock Matte	Altro Whiterock Chameleon	Altro Whiterock wall designs	Altro Whiterock PopArt
Format	panel	panel	panel	panel	panel
Thickness	2.5mm	2.5mm	2.5mm	2.5mm	2.5mm
Width	4' / 1.22m	4' / 1.22m	4' / 1.22m	4' / 1.22m	4' / 1.22m
Height	8' 2" / 2.5m 9'10" / 3.0m	9'10" / 3.0m	8' 2" / 2.5m 9'10" / 3.0m	8' 2" / 2.5m 9'10" / 3.0m	8' 2" / 2.5m 9'10" / 3.0m
Weight	8'2" - 23.59lbs 9'10" - 28.22lbs	9'10" - 28.22lbs	8'2" - 23.59lbs 9'10" - 28.22lbs	8'2" - 24.20lbs 9'10" - 28.57lbs	8'2" - 24.20lbs 9'10" - 28.57lbs
Warranty	20 years	20 years	20 years	10 years	varies

Test results

Surface burning CAN/ULC S102.1 + S102.2	tested				
Surface burning ASTM E84-08	Class A				
Impact resistance ASTM D5420	Exceeds 198 inch pounds				
USDA	Compliant				
FDA	Compliant				
CFIA	Compliant				

Sustainable attributes

Phthalate-free	✓	✓	✓	✓	✓
Low VOC	✓	✓	✓	✓	✓

Altro Whiterock Digiclad	Altro Whiterock Imagination Wall	Altro Whiterock Whiteboard	Altro Tegulis	Altro Puraguard
panel	panel	panel	panel	panel
2.5mm	2.5mm	2.5mm	2.5mm	2mm
4' / 1.22m	4' / 1.22m	4' / 1.22m	4' / 1.22m	4' / 1.22m
8' 2" / 2.5m 9'10" / 3.0m	3' / .9m (up to 9'10" / 3.0m)	8' 2" / 2.5m 9'10" / 3.0m	8' 2" / 2.5m 9'10" / 3.0m	9' / 2.75m 10' / 3.0m
8'2" - 24.20lbs 9'10" - 28.57lbs	3' - 9 lbs (up to 28.57lbs)	8'2" - 24.20lbs 9'10" - 28.57lbs	8'2" - 24.20lbs 9'10" - 28.57lbs	9' - 21.05lbs 10' - 23.4lbs
10 years	5 years	10 years	10 years	2 years

tested				
Class A				
Exceeds 198 inch pounds				Exceeds 64 inch pounds
Compliant				
Compliant				
Compliant				

✓	✓	✓	✓	✓
✓	✓	✓	✓	✓



even more Altro

We aren't just a floor and wall manufacturer - we are a partner in your project. We aim to deliver all the resources necessary for an exceptional experience.

Even more Altro

Floor accessories	138
Altro Whiterock accessories	142
Altro Puraguard accessories	145
Additional support	146
Installer training (floors + walls)	148
Your education path (CEUs)	150

Flooring accessories

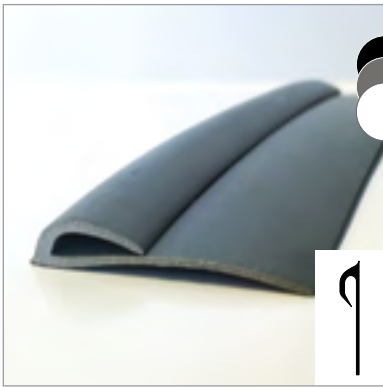

C7 Cap strip

C7BLK/DOVE/WHT

Pliable "J" shaped vinyl finishing cap used with flash covered sheet vinyl flooring. Available in Black, Gray and White.



20mm Cove stick

CF 20R

Used to create flash coving with resilient sheet flooring.

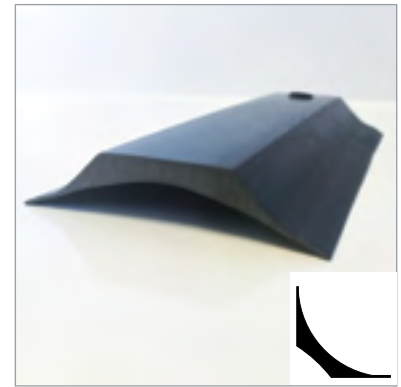

38mm Cove stick

CF 38R

Used to create flash coving with resilient sheet flooring.

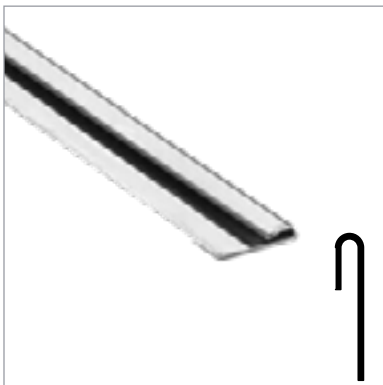

Stainless steel cap strip

SSCAP67

Stainless steel "J" shape finishing cap used with flash cove sheet vinyl flooring. Finish: 304 #4 stainless steel finish Gauge: 20



Stainless steel corner guard

3" and 5"

Protects external corners in high traffic areas.

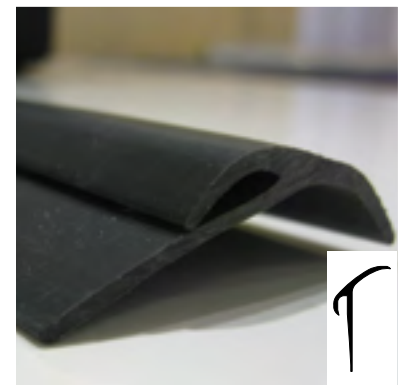

C11 Captile strip

C11

Pliable vinyl finishing cap used at the top of quarry tile base or similar when flash coving over existing tile.

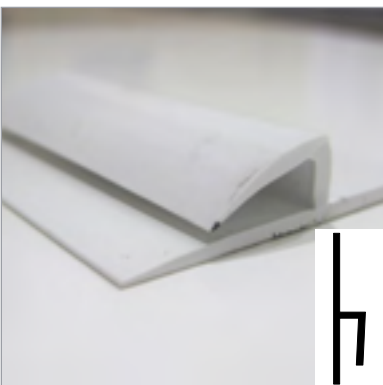

C8 Cap tile strip

C8

Rigid "h" shaped vinyl transition cap w/8mm shelf to be used between flash covered sheet flooring and wall tiles and/or wall cladding.

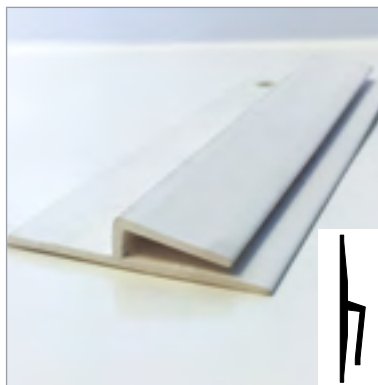

C4 Cap tile strip

C4Cap

Pliable "h" shaped vinyl transition cap w/4mm shelf to be used between flash covered sheet flooring and Altro wall panels.

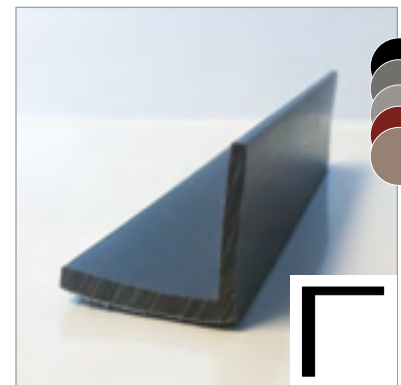

Gully angle

GA 25/35

Vinyl "L" shaped accessory to be heat welded to sheet vinyl and used with raised floor sinks that are higher than the finished floor level. Available in Black, Storm (Dark Gray), Fog (Light Gray), Russet (Quarry Red) and Tundra.

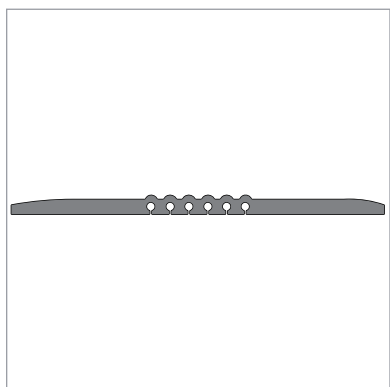

20mm Joint cover strip

JCS 75/20

Cover strip used when there is potential of control joints moving and showing through the finished floor.

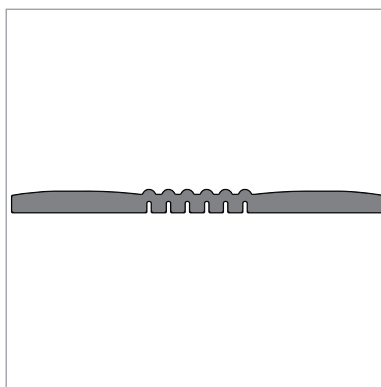

32mm Joint cover strip

JCS 75/32

Cover strip used when there is potential of control joints moving and showing through the finished floor.



Shower transition trim

ASF WETTRIM/* color code

Wheel chair accessible shower berm that prevents water egress from wet areas. Available in Cream(01), Light Gray(03), Medium Gray(04) and Light Brown (02).

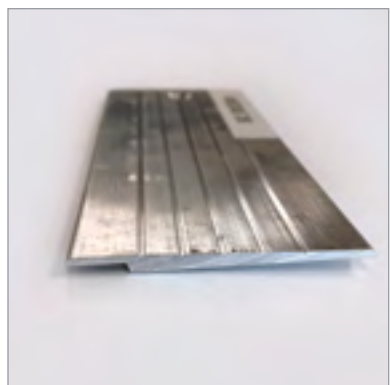

Visedge DS

VIEDGE DS

Aluminum over the top reducer threshold to finish a raw edge of flooring where it needs to transition down to zero.

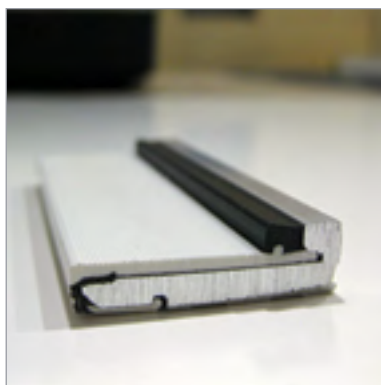

Visedge VR

VIEDGE VR

Aluminum alloy retainer with pvc insert to receive heat welded sheet vinyl that can abut a raised floor sink or quarry tile and patched down to zero.



Stainless steel heat deflector plate

SS DEFLECTOR PLATE

Protects vinyl flooring from high radiant heat. Ships with protective film covering. Size: 4'3

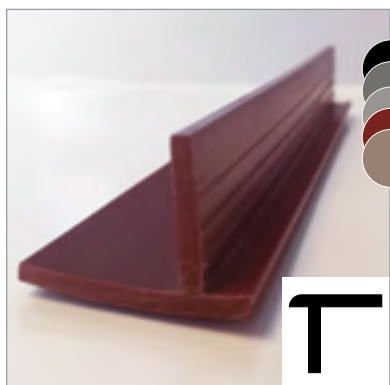

20mm Gulley edge with reducer

GE 25 RE

Vinyl "T" shaped accessory to be heat welded to sheet vinyl and used with floor sinks, square or rectangular trench drains. Available in Black, Storm (Dark Gray), Fog (Light Gray), Russet (Quarry Red) and Tundra.

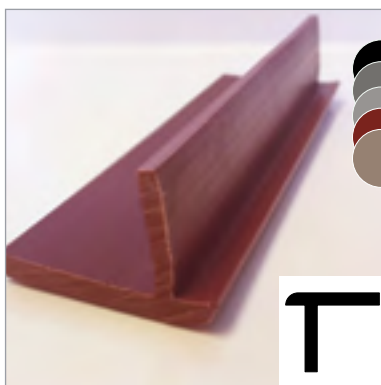

35mm Gulley edge with reducer

GE 35 RE

Vinyl "T" shaped accessory to be heat welded to sheet vinyl and used with floor sinks, square or rectangular trench drains. Available in Black, Storm (Dark Gray), Fog (Light Gray), Russet (Quarry Red) and Tundra.

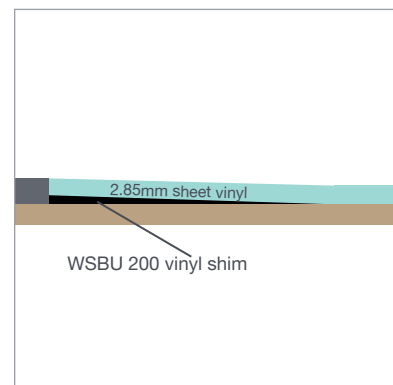

WSBU 200 vinyl shim

WSBU200

Vinyl shim use for transitioning smoothly between floors and walls or dissimilar flooring thickness when the transition is to be heat welded.

Flooring accessories continued



EcoFix 20E adhesive

ECOFIX20E

Environmentally friendly, hard set, acrylic adhesive used for vinyl sheet flooring.



EcoFix 25E adhesive

ECOFIX25E

Environmentally friendly, pressure sensitive, acrylic adhesive used for tile and/or plank flooring.



AltroFix 30 adhesive

ALTROFIX30

Two-part polyurethane adhesive used for installing safety sheet vinyl in high traffic and/or wet areas.



AltroFix 31 adhesive

ALTROFIX31

Fast-acting two-part polyurethane adhesive used for installing safety sheet vinyl in small, wet environments.



AltroFix SD70 acrylic adhesive

ALTROFIXSD70

One-part acrylic adhesive used for installing Altro Walkway 20SD in static sensitive areas.



Adhesive for recycled rubber flooring

RFA4.0

One-part polyurethane adhesive used for installing Altro Ollero.



EcoFix 65 Spray adhesive

ECOFIX65

Non-toxic, water-based adhesive used for tile and/or plank flooring.



EcoFix 35 Spray adhesive

ECOFIX35

Non-toxic, water-based adhesive used for resilient sheet vinyl flooring in dry environments.



Altro QuickFix 3042 epoxy caulking

QUICKFIX3042

Fast-reacting, two-part self-mix epoxy caulking adhesive used for gully edge/angle installation and small repairs.



W165 Tape adhesion promoter
W165
Ensures tape adheres properly to substrate.



AltroMastic 100
A1M/* add color code.
Caulking compound used for sealing joints where obstructions prevent the use of a heat welding gun.



Weldrod
WR* add color code.
PVC welding rod for use with Altro sheet vinyl flooring.



Adhesive-free tape
XL Tape 25
For adhering adhesive-free sheet vinyl in place.



Contact tape
1" CFS Capfix
4" and 6" CFS Covefix
Adheres cove stick and flashed covered flooring in place.



Altro Everlay underlayment
MEA1.2
For installing sheet vinyl over old or new surfaces with subfloor problems.

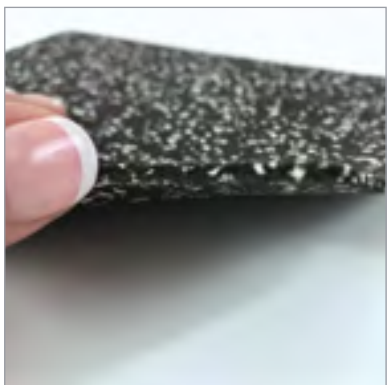

Altro Acoustic underlay 1101
AAU1101L36
For reducing the passage and transmission of sound.

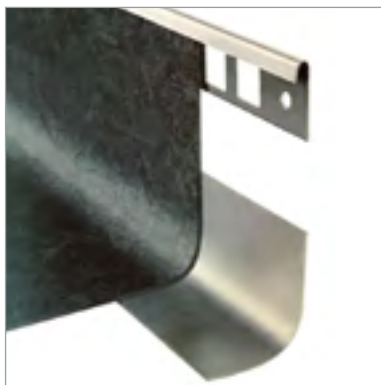

FlashCove
FLASHCOVE* add Small toe/Large toe
Prefabricated, covered base with a bonded aluminum reinforcing backer.



Altro Drain strainer cover
ADSC-5Z (5" fit Zurn)
ADSC-5MW (5" fit Mifab/Watts)
For ease in creating a modified drain with pre-existing assemblies.

Altro Whiterock accessories



1-Part start and edge trim

8'2" G833/25/* add color code
 9'10" G833/30/* add color code
 Covers the edge of the sheet and gives a secure, finished edge.



1-Part joint strip

8'2" G831/25/* add color code
 9'10" G831/30/* add color code
 Vertical joint strip used to join adjacent sheets includes neoprene seal to make the joint watertight.



1-Part concealed transition strip

8'2" G835/25
 Used as a leveling strip between two surfaces so that one can overlap the other.



2-Part start and edge trim

8'2" A833/25/* add color code
 9'10" A833/30/* add color code
 2-part transition piece used to finish a raw edge of Altro Whiterock i.e. top edge of wainscoting.



2-Part joint strip

8'2" A831/25/* add color code
 9'10" A831/30/* add color code
 Joins two wall panels together to create a smooth finish in areas where heat welding isn't viable.



2-Part cut tile transition strip

A832/25/* add color code
 Used as a transition piece between Altro Whiterock and flashed covered flooring.

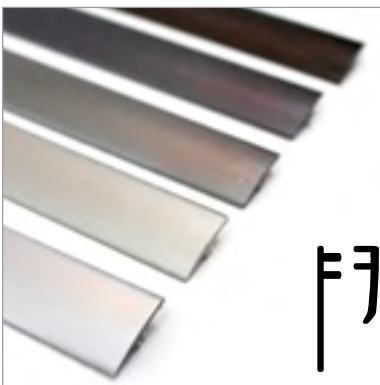

2-Part start and edge trim

8'2" A833/25/* add color code
 9'10" A833/30/* add color code
 Metallic visual 2-part transition piece used to finish a raw edge of Altro Whiterock wall designs i.e. top edge of wainscoting.

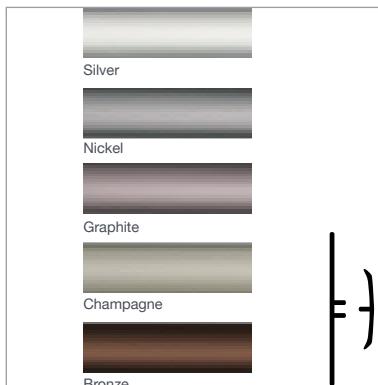

2-Part joint strip

8'2" A831/25/* add color code
 9'10" A831/30/* add color code
 Metallic visual strip joins two Altro Whiterock wall designs panels to create a smooth finish in areas where heat welding isn't viable.



Sanitary sealant

White - A802
 Clear - A803
 Color - A805/* add color code
 For creating a hygienically-sealed edge.



AltroFix W39 2-part adhesive
W39

For adhering Altro Whiterock on both porous and non-porous substrates, in wet and high humidity environments and when heat welding is specified.



W165 Tape adhesion promoter
W165

Ensures tape adheres properly to substrate.



AltroFix W157 acrylic adhesive
W157

For adhering Altro Whiterock on porous substrates and dry applications only.

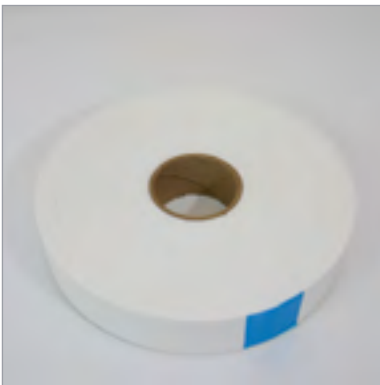

Double-sided foam tape

1" A815/116

2" A815/216

1/16" thick foam mounting tape used for installing Altro Whiterock when heat welding seams.

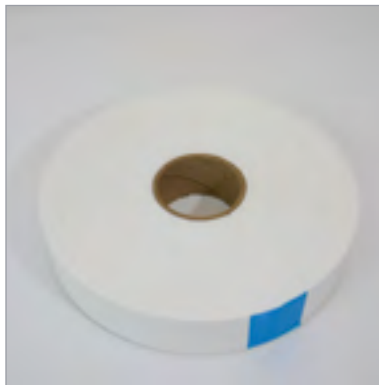

Double-sided foam tape

1" A815/132

2" A815/232

1/32" thick foam mounting tape used for installing Altro Whiterock when heat welding seams.



Double-sided butyl tape

A815/30

For installing Altro Whiterock panels while using joint strips.



Weldrod

WSR* add color code

PVC welding rod for use with Altro sheet vinyl wall cladding.

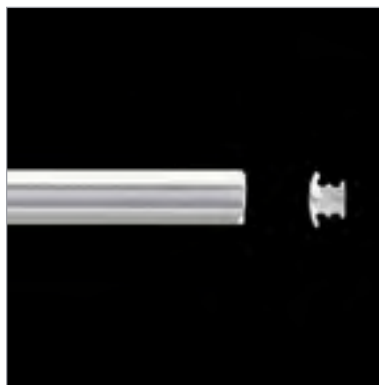

FlexiJoint strip

FJ01/3MH

FJ* add color code for coil

Unobtrusive, almost-invisible joints for installing Altro Whiterock panels. Available in white strips and custom coils.

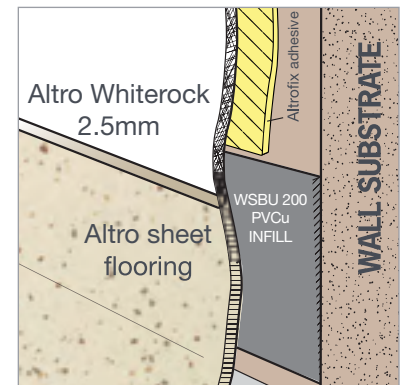

Heat weld backer

WSBU200

Vinyl shim backer for creating a solid and smooth transition between floors and walls when heat welding this seam.

Altro Whiterock accessories continued

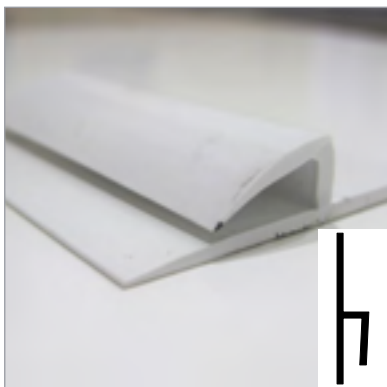

C8 Cap tile strip

C8

Rigid "h" shaped vinyl transition cap w/8mm shelf to be used between flash covered sheet flooring and Altro Whiterock



C4 Cap tile strip

C4Cap

Pliable "h" shaped vinyl transition cap w/4mm shelf to be used between flash covered sheet flooring and Altro Whiterock.



FlexiJoint steel spacers

FJS/3.4

Used for setting the gap between panels accurately when using Flexijoint strips.



Stainless steel corner protector

4' A861/12

8' A861/13

Protects external corners in high traffic areas.



Shower Recessed Shelf

A900

A factory formed hygienic insert that can be welded directly to panels, offering a water-tight, rust-proof shelf for your shower toiletries.



1-Part stainless steel joint strip

A855

Joins two stainless steel wall panels together to create a smooth finish in areas where stainless steel is required.

Altro Puraguard accessories



AltroFix W157 acrylic adhesive

W157
For adhering Altro Puraguard on porous substrates, in dry applications only.



AltroFix W39 2-part adhesive

W39
For adhering Altro Puraguard on both porous and non-porous substrates and in wet and high humidity.



Altro W147 Spray adhesive

W147
Non-toxic, water-based adhesive used for Altro Puraguard wall panels.

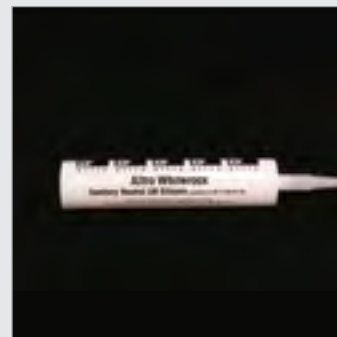

Sanitary sealant

White - A802
Clear - A803
Color - A805/* add color code
For creating a hygienically-sealed edge.



1-Part joint strip

G731/30/*
"H" shaped transition strip that joins two Altro Puraguard panels together. Available in Salt(white), Pepper(gray) and Barley(tan).

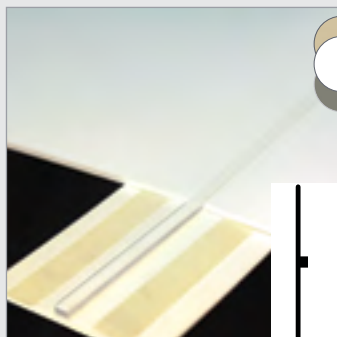

1-Part Altrotite gasket trim

A840/30/*
Trim piece used between two Altro Puraguard panels to join unobtrusively. Available in Salt(white), Pepper(gray) and Barley(tan).



1-Part start and edge trim

G733/30/*
"J" shaped piece used to finish off Altro Puraguard panel at top or sides (i.e. top of wainscoting). Available in Salt(white), Pepper(gray) and Barley(tan).



Stainless steel corner protector

4' A861/12
8' A861/13
Protects external corners in high traffic areas.

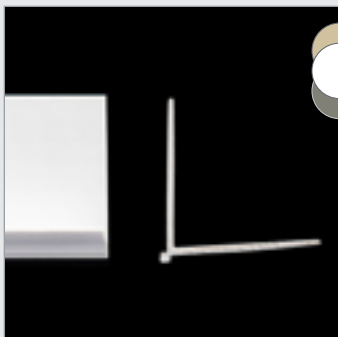

External corner cover

A839/30
"L" shaped piece used to finish off where the Altro Puraguard meets an external corner. Available in Salt(white), Pepper(gray) and Barley(tan).

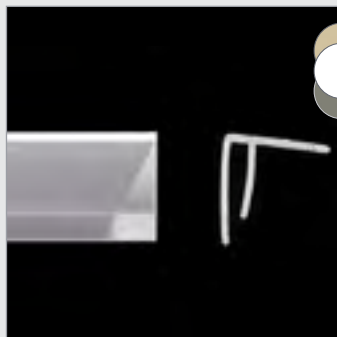

Internal / external corner trim

A826/30
"F" shaped piece that can be used to finish off Altro Puraguard at internal and external corners. Available in Salt(white), Pepper(gray) and Barley(tan).



C8 Cap tile strip

C8
Rigid "h" shaped vinyl transition cap w/8mm shelf to be used between flash covered sheet flooring and Altro Puraguard.

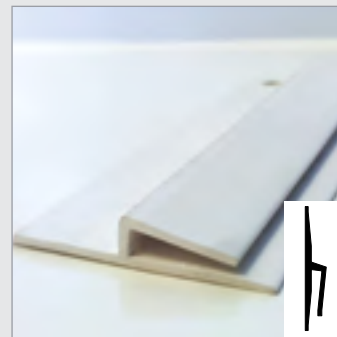

C4 Cap tile strip

C4Cap
Pliable "h" shaped vinyl transition cap w/4mm shelf to be used between flash covered sheet flooring and Altro Puraguard.

Additional support



Samples

Samples are available 24 hours a day on altro.com as well as materialbank.com



Literature

An abundance of literature from catalogs like this to sector brochures, product brochures and more on altro.com



Color inspiration

Not everyone has an interior designer! If you are looking for color inspiration for your smaller project visit altro.com

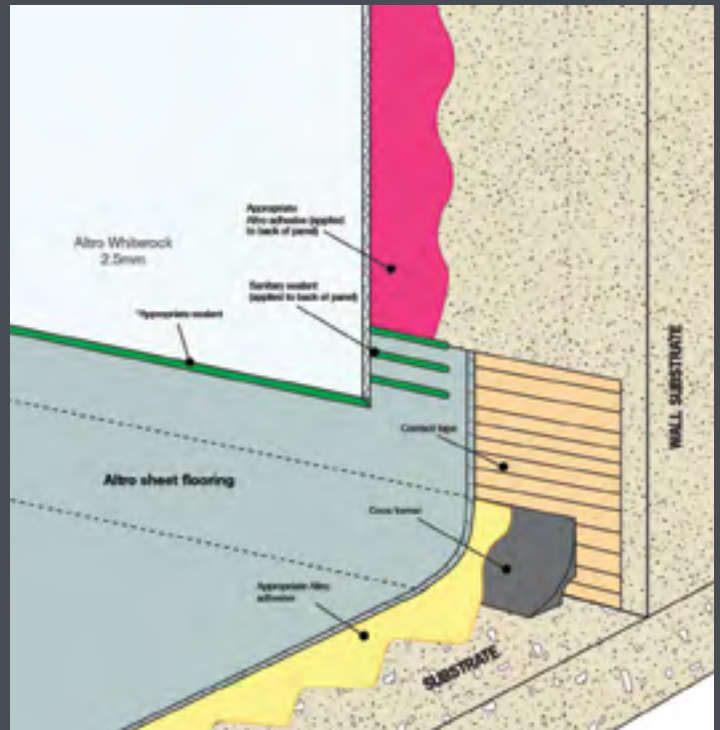

BIM, CAD and detail drawings

Resources to make project specifications and installation as smooth as possible are available on altro.com



Technical documents

Installation guides, maintenance guides, sector-specific detailing and contractor tips are all available on altro.com



Installation photos

A large library of installation photography is available on altropics.com or navigate there from altro.com

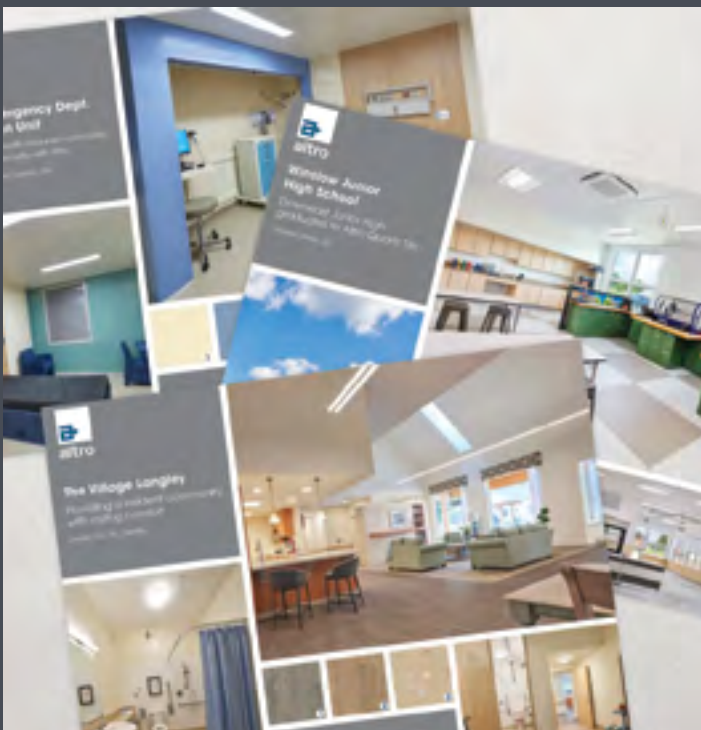

Case studies

References, quotes and images from real life customers are always updated on altro.com

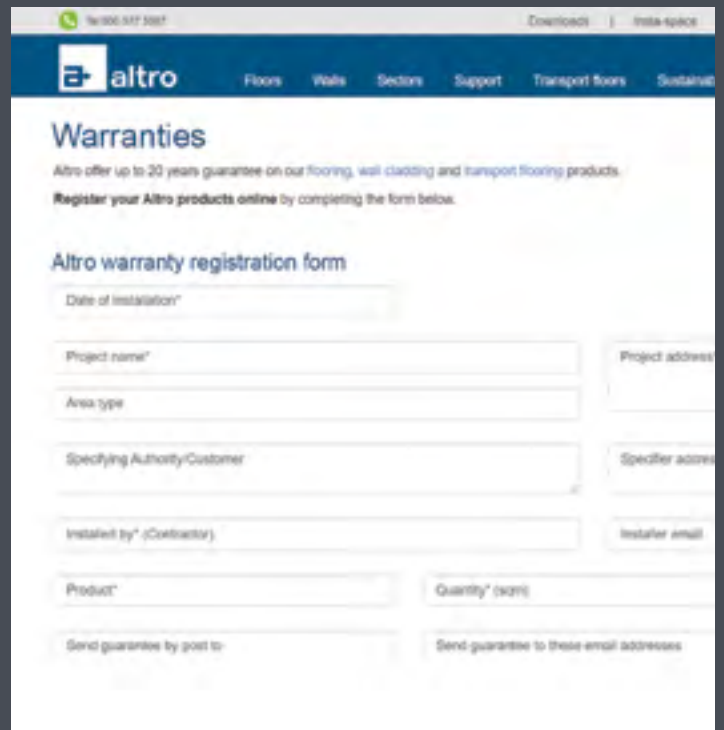

Online warranty submittal

Submitting your product warranty is now easier than ever on altro.com

Becoming a recommended installer



The goal of the Altro training academy is to train and qualify a network of professional flooring and walling installers who wish to become part of a specialized group of recommended Altro installers and fitters. The academy is ideal for flooring installers, general contractors, and carpenters looking to learn how to install these specialized commercial products. Altro stands behind our installers and always recommends that customers use Altro trained installers.

Two training centers are located in the United States. They are located in Wilmington, Massachusetts and Santa Fe Springs, California. We also have a Canadian facility located in Mississauga, Ontario. Typical installation scenarios are integrated with best practices for a better, hands-on, learning experience.

Flooring curriculum

- Adhesive application
- Scoring
- Trimming
- Corners
- Heat-welding
- Flash-coving
- Integrated drains
- Best practices

Wall curriculum

- Adhesive application
- Surface preparation
- Wall fitting
- Grooving
- Joining
- Heat-welding
- Flexjoint
- Transition strips
- Thermoforming
- Best practices

USA clinic locations

- Wilmington, MA
- Santa Fe Springs, CA

CANADA clinic locations

- Mississauga, Ontario



For more information please visit altro.com or navigate using the QR code shown. Registration and pre-qualification forms are also available through this link.

scan me using your smartphone's camera application or a QR reader application.



Customize your education path with us



We work with architects, designers, contractors and end users in healthcare, education, food service and other sectors, and from safety to aesthetics, use our expertise to help them transform everyday spaces into thriving environments. Please take a look at the accredited courses, non-accredited presentations and technical demonstrations we deliver regularly. We are always happy to create a learning event for your unique needs and schedule.

Non-accredited courses and demonstrations

Products

- Safety flooring
- Slip-resistant flooring
- Adhesive-free flooring
- Smooth sheet flooring
- Smooth tile and planks
- Comfort flooring
- Recycled rubber floors
- Exterior flooring
- Wet environments
- Walls
- Digitally printed walls
- Tile-look walls

Sectors

- Senior living
- Healthcare
- Commercial kitchens
- Education
- Cleanrooms
- Hospitality

Demonstrations

- Adhesive-free
- Wet environments
- Altro Whiterock
- Altro Tegulis

AIA/CES, IIDA/IDCEC approved CEU courses

Additional courses on next page 

Hygienic operating room design

An informative seminar that examines the unique challenges and guidelines that must be addressed when designing operating rooms.

1 LU
1 HSW

AIA
CES
IIDA
IDCEC



Designing for education

An informative seminar that examines the unique challenges that must be addressed when designing interiors for both K-12 and higher education.

1 LU

AIA
CES
IIDA
IDCEC

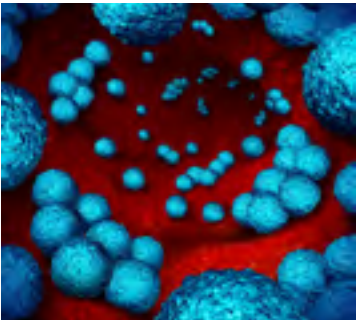

Preventing infection

An informative seminar examining the dangers of Healthcare Acquired Infections (HAIs) like MRSA, VRE and ESBL and how they can be avoided by selecting proper flooring and wall cladding finishes.

1 LU
1 HSW

AIA
CES
IIDA
IDCEC



Designing for an aging population

An informative seminar examining the difficulties seniors face with everyday tasks and how designing interiors to meet those needs creates a safe and comfortable environment.

1 LU
1 HSW

AIA
CES
IIDA
IDCEC



Designing for behavioral and mental health

An informative seminar that provides an in-depth examination of the statistics surrounding behavioral and mental health (BMH) as well as facilitating treatment while promoting safety through successful BMH design.

1 LU
1 HSW

AIA
CES
IIDA
IDCEC

AIA/CES, IIDA/IDCEC approved CEU courses continued

Designing for underfoot comfort

An informative seminar that examines the correlation between flooring and its degree of underfoot comfort in relation to the development and prevention of musculoskeletal disorders in employees across various industries.

1 LU
1 HSW

AIA
CES
IIDA
IDCEC



Safety by design

An informative seminar examining the dangers associated with slips and falls and the importance of choosing appropriate flooring.

1 LU
1 FCSI

AIA
CES
IIDA
IDCEC



Healthy building design

An informative seminar focused on promoting safety through linking the built environment to human health, as well as examining the impact of floor and wall surfaces on the wellbeing of employees.

1 LU
1 HSW

AIA
CES
IIDA
IDCEC

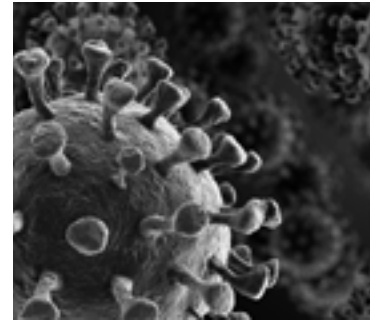

Designing for healthcare: wet environments

An informative seminar that provides a detailed overview of proper flooring, wall cladding and fixtures for wet environments in healthcare settings. Learn detailing and installation methods where safety is a primary focus.

1 LU
1 HSW

AIA
CES
IIDA
IDCEC

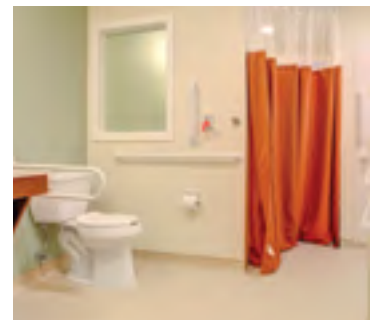

Sign-up or inquire about a CEU, presentation or demonstration on altro.com or navigating with the QR code shown here.

scan me using your smartphone's camera application or a QR reader application.





Certificate of Incorporation

I HEREBY CERTIFY that THE ADAMITE COMPANY, LIMITED is this day incorporated under the Companies Acts, 1908 to 1917, and that the Company is LIMITED. Given under my hand at London this Seventh day of April, One Thousand Nine Hundred and Nineteen.

A. E. TAYLOR,

Assistant Registrar of Joint Stock Companies.

SHARE CERTIFICATE The Adamite Company, Limited.

CAPITAL £1,000,
Divided into 1,000 Shares of One Pound each.

This is to Certify that *Fredric Abemethy Colman Esq* of *Heathbank, Weybridge* is the Registered Proprietor of *one* of One Pound each, numbered *998* to *—* inclusive, in the above-named Company, subject to the Memorandum and Articles of Association and Regulations of the said Company.

Given
Company, this
Paul Barton



ADAMITE

make
ALTRO FLOORINGS
Safety and Heavy Duty
and
VYNOLEUM
The flooring with the two best sides

ALTRO HEAVY DUTY FLOORING
Pure P.V.C. on a hessian base. 2.5 m.m.
ALTRO SAFETY FLOORING
as above but containing aluminium oxide
abrasive grain. 2.5 m.m. and 4 m.m.
Of exceptional toughness these industrial
floor coverings have a tested wear resistance
greater than that of pressed granite paving
flags. Unaffected by chemicals, variations in
temperature or excess moisture, Altro
floorings have been developed to satisfy the
most exacting demands. Installations include
Hospitals, Laboratories, Breweries, Factories,
Banks, Offices, Schools and Golf Clubs.
Heavy Duty in rolls 72" wide and laid for
approximately 22/- per sq. yard. Safety, as
above, in rolls 72" wide and laid for approximately 30/- per

How much longer can Altro Safety go on performing at the London Palladium

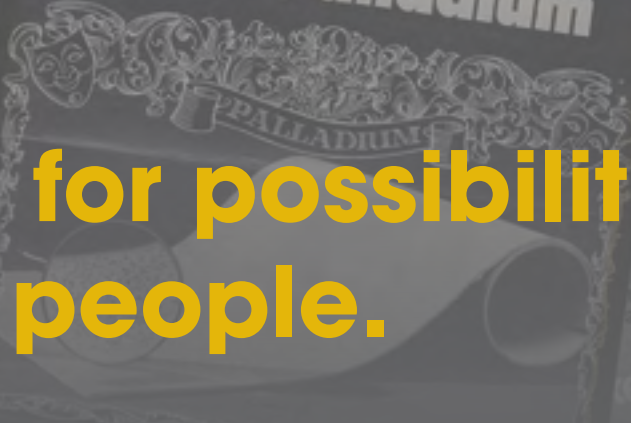

Safety Flooring
to take a beating
ing down...

Designed for possibilities. Made for people.

In SCHOOLS it provides safety under wet and dry conditions at a competitive price.
Numerous other industrial institutions have proved the qualities of Altro Safety.
Are you making full use of your current flooring?
keeps people standing

ALTRO LTD

Ask us in



Featured color palette

The classic combination of warm neutrals and natural woodgrain showcased on the front cover. This color palette features the following Altro products (left to right)

- Altro Whiterock wall designs - Rich Woodgrain
- Altro Whiterock - Linen
- Altro Operetta - Glee
- Altro Orchestra - Oboe
- Altro Serenade - Charm
- Altro Wood adhesive-free - Antique Walnut
- Altro Lavencia LVT - Farmhouse Whiskey
- Altro Classic 25 - Walnut
- Altro Dolce Tile - Arbol



Scan to order this free sample set

Follow us



ALTRO PRODUCT CATALOG

📞 **USA** 800 377 5597

📞 **CANADA** 800 565 4658

✉️ support@altro.com

🌐 www.altro.com

Content correct at time of going to print. Altro reserves the right to change any detail. Please consult www.altro.com or your local Sales Representative for the latest product range information. Imagery for representation only. Lighting and photography filters can change the appearance of flooring in installation photos. Please order a sample for color approval.